



Machine Automation Solutions Catalog





Table of Contents

1. Overview

Total Solutions for Machine Automation	1
--	---

2. PAC Solutions

2.1 EzProg + MPAC Motion Control Solutions	2-1-1
MP-8343 / MP-8743 / MP-8353 / MP-8753	2-1-3
2.2 ISaGRAF + XPAC Motion Control Solutions	2-2-1
XP-8047-CE6 / XP-8347-CE6 / XP-8747-CE6	2-2-3
2.3 Motion Modules For PAC.....	2-3-1
I-8092F-G.....	2-3-2
I-8094-G.....	2-3-4
I-8094F-G.....	2-3-6
I-8094A-G.....	2-3-8
I-8094H-G	2-3-10



3. PC-based Solutions

PC-based PCI/ISA Bus Motion Control Cards	3-1
PISO-PS200	3-3
PISO-PS400	3-5
PISO-PS410	3-7
PISO-PS600	3-9
PISO-PS810	3-11
PISO-ENCODER300U	3-13
PISO-ENCODER600U	3-14
PISO-PS300U	3-15
PMDK	3-16
ENCODER300.....	3-17
STEP-200	3-18
SERVO-300.....	3-19



4. Remote Motion Solutions

Remote Motion Solutions	4-1
4.1 Ethernet Motion Control Solutions	4-1-1
ET-M8194H	4-1-3
4.2 Motionnet Solutions	4-2-1
PISO-MN200/PISO-MN200T	4-2-2
MN-SERVO Series	4-2-3
MN-SERVO EC Series.....	4-2-5
MN-2091U/MN-2091U-T.....	4-2-7
MN-3253/MN-3253T	4-2-9
MN-3254/MN-3254T	4-2-11
MN-3257/MN-3257T	4-2-13
4.3 CANopen Motion Solutions.....	4-3-1
PISO-CPM100U	4-3-3
I-7565-CPM	4-3-4
I-8123W	4-3-5



5. Accessories

5.1 Terminal Boards.....	5-1-1
5.2 FRnet Remote I/O Modules	5-2-1
5.3 Cables and Connectors.....	5-3-1



Overview



1. Overview

Total Solutions for Machine Automation	1-1
• PAC Solutions	1-2
1. EzProg + MPAC Motion Control Solutions	1-2
2. ISaGRAF + XPAC Motion Control Solutions	1-2
• PC-based Solutions	1-3
PCI / ISA Bus Motion Control Cards	1-3
• Remote Motion Solutions	1-4
1. Ethernet Solutions	1-4
2. Motionnet Solutions	1-5
3. CANopen Solutions	1-5



Trademarks

Trademarks, trade names, logos, service marks and the product names ("Marks") described in this document are the property of ICP DAS or other third parties. Unauthorized use of the Marks is not permitted without the prior written consent of ICP DAS or such third parties that may own the Marks.

1. Overview

1

Overview

Total Solutions for Machine Automation

Total Solutions

As a leading automation solutions provider, ICP DAS provides a wide range of motion solutions for machine automation systems, including PAC solutions MPAC and ISaGRAF XPAC products based on a variety of development software such as EzProg and ISaGRAF for PAC motion control systems, PC-based solutions developed using PCI/ISA bus motion control products for PC-based motion control systems, and remote motion solutions using Ethernet, Motionnet or CANopen motion control products for remote motion control systems.

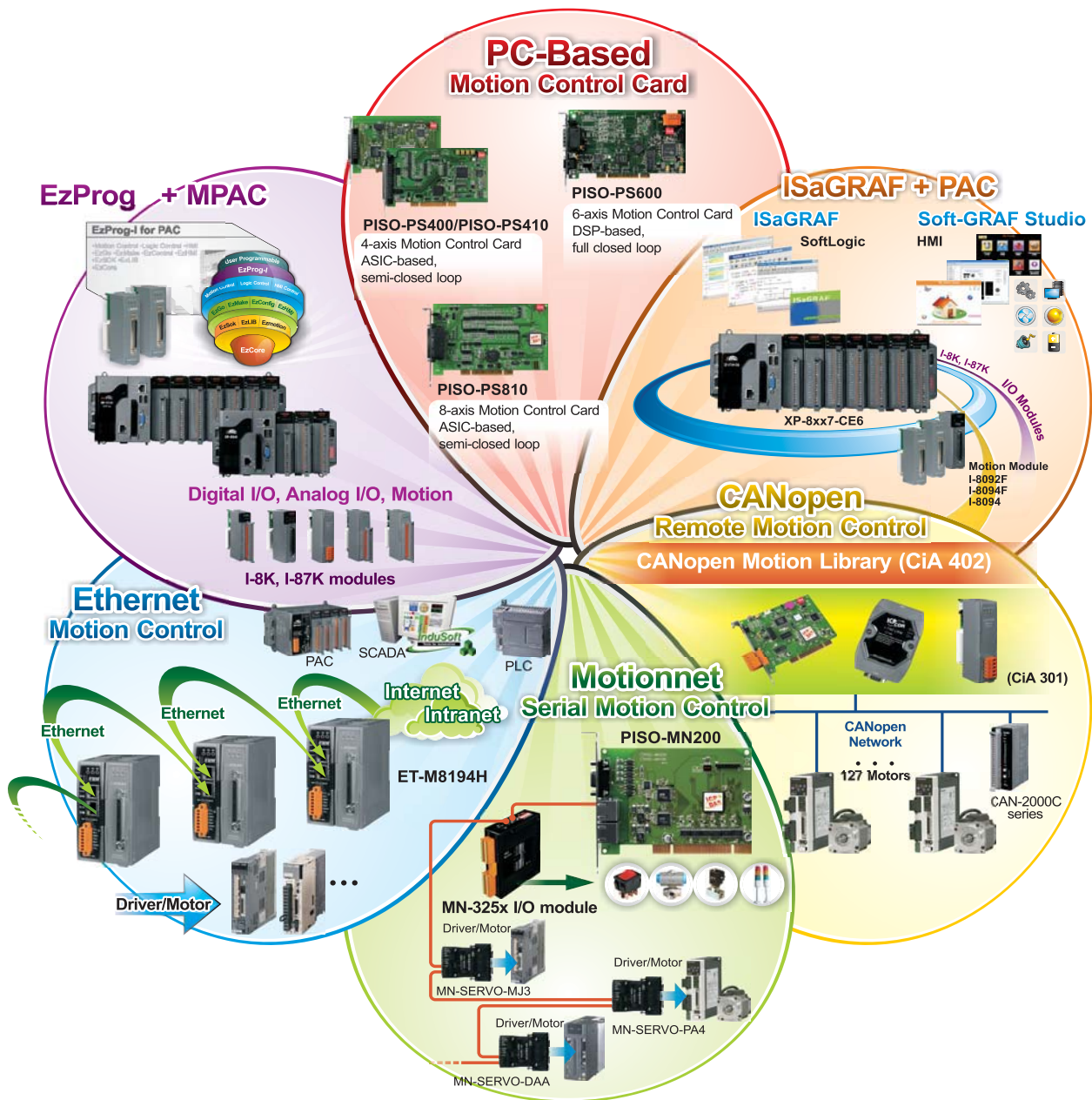

• PAC Solutions

1. EzProg + MPAC Motion Control Solutions

By using EzProg-I development software, Machine automation PAC controllers (MPAC Series) are truly better alternatives to much traditional PLCs, allowing the integration motion control much more effectively than a PLC-based system. In the field of machine automation, there are a lot of applications requiring to combine together motion control and logic control. The EzProg + MPAC Motion Control Solution from ICP DAS is one of the best choices available.



2. ISaGRAF + XPAC Motion Control Solutions

As a pioneer of PAC, ICP DAS provides a new PAC motion control solution - ISaGRAF + XPAC Motion Control Solution. Integrating with the ISaGRAF development software and the Soft-GRAF HMI, the XPAC series plus the I-8094F/8094/8092F motion control solution allows users to easily design and implement a professional and user-friendly system with effective integration of motion controls, logic controls and I/O device controls.

Digital I/O, Analog I/O, Motion

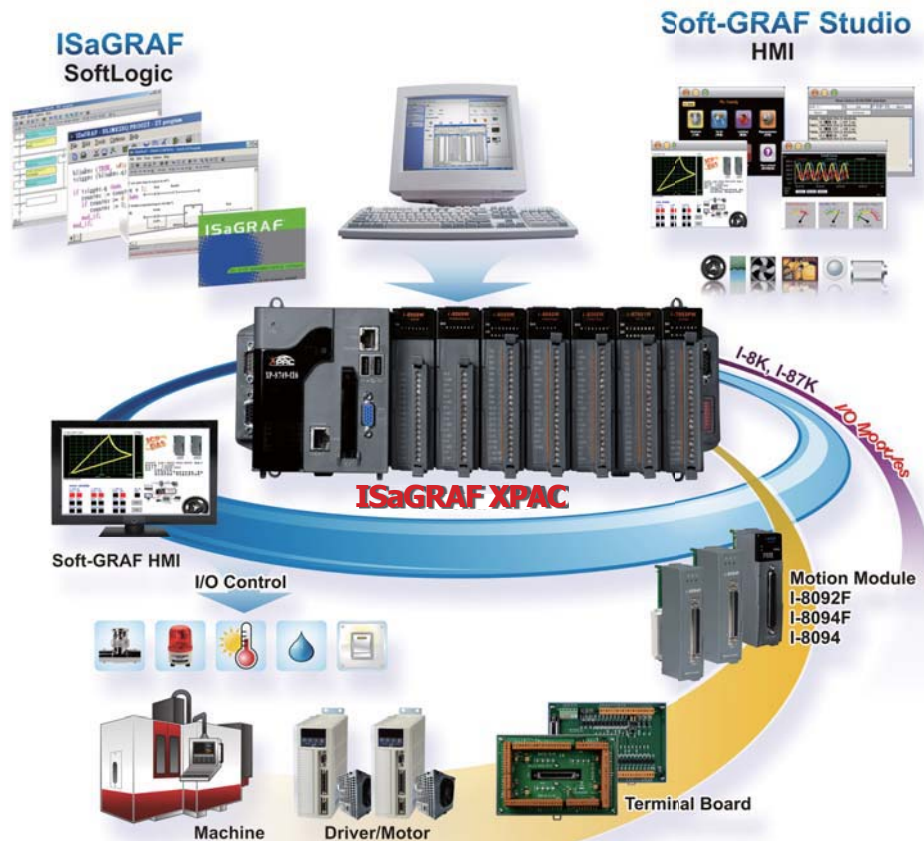

• **PC-based Solutions**

As a leading automation solutions provider, ICP DAS not only provides PAC motion control modules for use with our own PAC systems, but also develops a wide range of PCI bus and ISA bus motion control products for PC-based control systems.

Most Cost-Effective
Wide Range Products
Best Service

PISO-PS810
 8-axis Motion Control Card
 ASIC-based, semi-closed loop

PISO-PS600
 6-axis Motion Control Card
 DSP-based, full-closed loop

PISO-PS400/PISO-PS410
 4-axis Motion Control Card
 ASIC-based, semi-closed loop

Servo Motors
 Yaskawa
 Mitsubishi
 Sanyo Denki
 Panasonic

Terminal Boards
 DN-20M
 DN-84100U
 DN-8468UB
 DN-8368GB/
 DN-8368UB

FRnet I/O
 FR-2024 series
 FR-2017 series
 FR-2057 series
 FR-2053 series

• Remote Motion Solutions

ICP DAS provides a range of remote motion control solutions that allows motion control anywhere at any time.

1. Ethernet Remote Motion Solutions

The Ethernet motion solution uses the ET-M8194H Ethernet Motion Control Unit to control and configure a motion card, such as the I-8094H for example, at the remote site (PC-, PLC- or SCADA-based systems) via an Ethernet interface using the Modbus TCP protocol to create a motion automation control system.

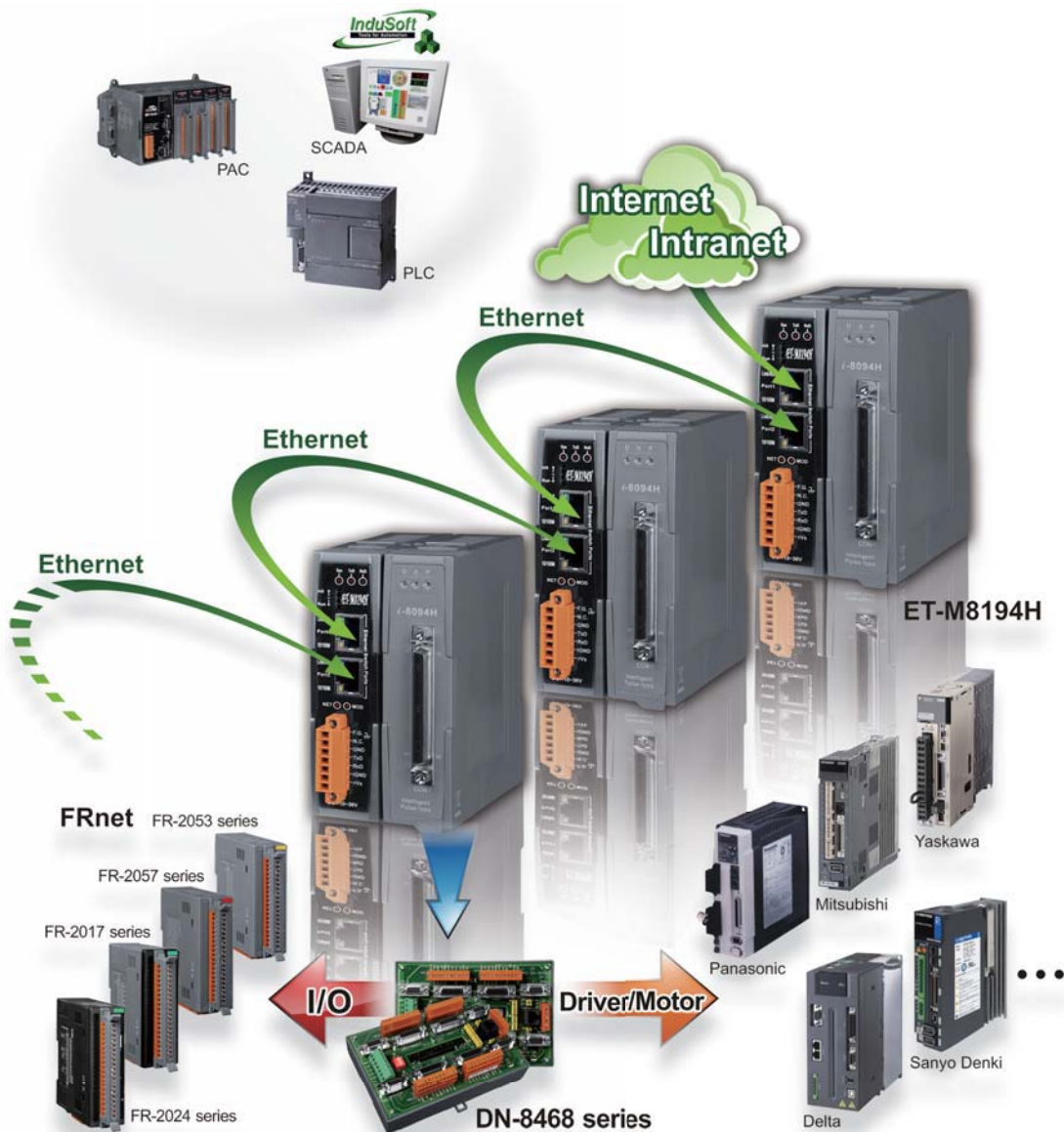

2. Motionnet Remote Motion Solutions

The **Motionnet motion solutions** provide a high-speed serial communication system that operates with either a Servo motor or a Stepping motor. Motionnet communication is based on a proprietary RS-485 technology (Multi-drop, Half-duplex) that allows considerable savings in wiring requirements, provides effective long-distance high-speed communication.

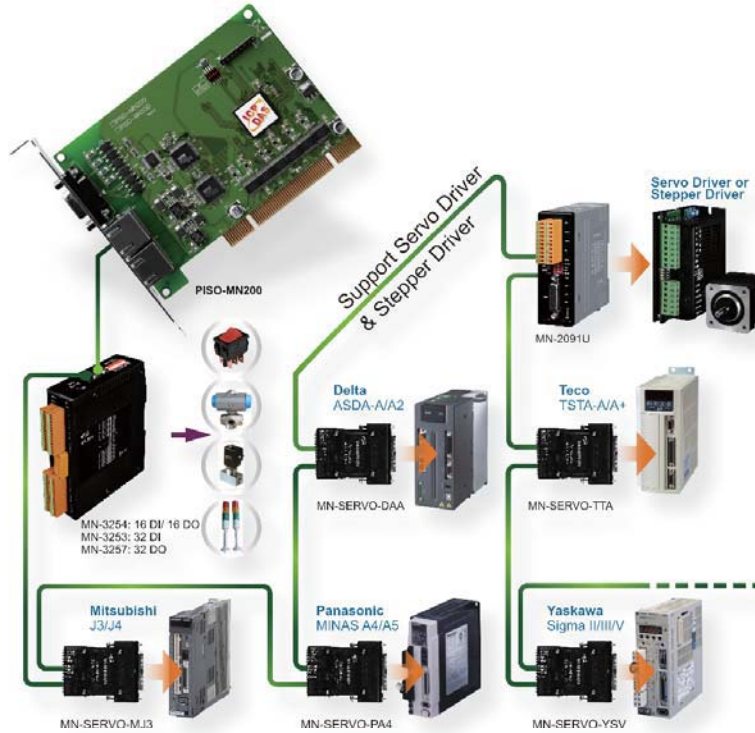

3. CANopen Remote Motion Solutions

The **CANopen motion solutions integrate** a motion control system with a CANopen network using the CANopen Master devices. Users are able to control CANopen motors and remote I/O devices located on the same network, making wiring connections and control both easy and more efficient.

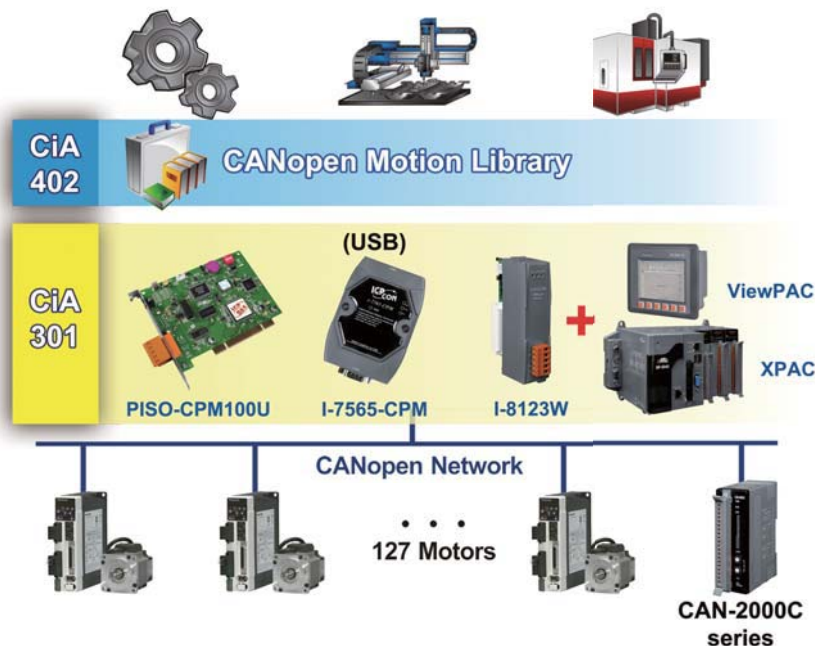

PAC Solutions



2. PAC Solutions

- 2.1 EzProg + MPAC Motion Control Solutions..... 2-1-1**
 - MPAC (Motion PAC) Series - MP-8xx3..... 2-1-3

- 2.2 ISaGRAF + XPAC Motion Control Solutions..... 2-2-1**
 - ISaGRAF XPAC Series - XP-8xx7-CE6/XP-8xx7-Atom-CE6..... 2-2-3

- 2.3 Motion Modules for PAC (MPAC or ISaGRAF XPAC)..... 2-3-1**
 - I-8092F-G..... 2-3-2
 - I-8094-G..... 2-3-4
 - I-8094F-G..... 2-3-6
 - I-8094A-G..... 2-3-8
 - I-8094H-G..... 2-3-10



2. PAC Solutions

2.1 EzProg + MPAC Motion Control Solutions

2

1

PAC Solutions



Introduction

The MP-8000 is a motion programmable automation controller (MPAC) combining the functionality and openness of a PC with the reliability and simplicity of a programmable logic controller (PLC). The price-performance of the MPAC is unbeatable when compared with a PC, PLC, and DCS. The MP-8000 is designed for time-critical and deterministic operations. Its field of application is unlimited, including factory automation, building automation, machine automation, laboratory automation, chemical industry and environmental monitoring, M2M, etc.

The MP-8000 is part of the new generation of programmable automation controllers from ICP DAS. It is equipped with an AMD LX 800 CPU (500 MHz) or Atom Z510, a Windows Embedded CE6 Operating System, a variety of ports (VGA, USB, Ethernet, RS-232/RS-485) and either 3 or 7 slots for connecting high performance parallel-type I/O modules. Compared with the first generation of WinCON-8000, not only the CPU performance is improved, but also many additional reliability features are included, such as dual LAN, redundant power input, dual battery backup SRAM, etc.

MP-8000 ≡ IPC+I/O Cards



Windows Embedded CE is a componentized, real-time, high performance, and highly reliable operating system. Windows CE 6 R3 delivers a rich user experience and a unique connection to Windows PCs, servers, services, and devices. The MP-8000 also supports the EzProg-I software development package offered by ICP DAS.

Development Software - EzProg



The EzProg-I PAC Automation Solution

EzProg-I is a total software solution for manufacturers or control system designers that simplifies system configuration, logic programming and HMI design. By using EzProg-I, engineers who are familiar with PLC systems can easily transfer their programming experience to ICP DAS's programmable automation control (PAC) solutions. The EzProg-I software makes it much easier for customers to integrate PLCs and IT technologies into a PAC environment.

The EzProg-I package contains a side range of development tools and libraries, such as EzConfig, EzGo, EzHMI, EzLib and EzCore. Based on these development resources, customers can directly configure and test the PAC channels and motion control modules without requiring additional programming. In addition, the EzProg-I simplifies the I/O instructions and provides a PLC-like I/O mapping table that assists the system designers in developing and testing the control system application.

Development Structure

The EzProg-I structure is divided into three main parts:

1. Upper layer: EzHMI

EzHMI provides a number of ActiveX controls which allow the programmer to create a graphical interface on a WinCE system. The EzHMI object can be directly linked to an I/O mapping table that makes the reading and writing of digital and analog I/O values very easy. The EzCore engine that operates in the background is responsible for updating the I/O table in real time.

Main MPAC Components

1 Main Control Unit (MCU)

The MCU is the powerhouse of the MP-8000. Each MCU comprises a Central Processor Module (CPM), a power supply, and either a 3- or 7-slot backplane for I/O modules. The CPM is a powerful integrated processing engine comprising a CPU, RAM and ROM, and communication interfaces for Ethernet, RS-485, RS-232 and FRnet.

2 Embedded OS - Windows CE6

Windows CE 6 is the next generation of real-time OS offered by Microsoft. Windows CE 6 provides the software engineer with familiar tools and innovative technologies designed to reduce the development time of application software. The high performance and high reliability of the MP-8000 together with the Windows CE, makes the MP-8000 an ideal controller in an environment where time-critical performance is required. The Windows CE6 operating system kernel architecture supports up to 32,000 simultaneous processes, each of which runs in a 2GB virtual memory address space. This allows developers to incorporate a larger number of complex applications into the MP-8000.

3 I/O Modules

There are two types of I/O module: parallel and serial. The parallel modules (I-8K high profile series and motion series) are high-speed modules and have to be installed in the slots of the MP-8000. The serial I/O modules (I-87K high profile series) can either be installed in the slots (MP-8000) or expansion units (RU-87Pn).

4 Remote I/O Expansion

The MP-8000 has built-in RS-485 and Ethernet ports to connect to remote I/O units (RU-87Pn/ET-87Pn) or I/O modules (I-7000/M-7000/ET-7000). By installing CAN or FRnet communication modules, the MP-8000 can exchange data with CAN bus devices, remote I/O units or FRnet I/O modules for deterministic control systems.

2. Intermediate layer: API

The EzProg-I provides common APIs for accessing different I/O modules types. In the past, each module type could only be accessed via its own APIs, meaning that different APIs had to be called in order to communicate with different modules. The EzProg-I now solves this problem and unifies all APIs, so that no matter which I/O module you need to exchange data with, only one API needs to be called. EzProg-I enables PLC-like programming by providing APIs for accessing EzCore registers that consist of the I/O mapping table and non-hardware related tables.

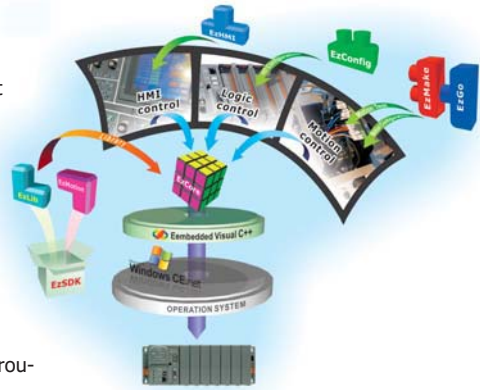

3. Lower layer: Logic control design

The control software provides three different design methods:

- 8 User thread procedures:
The user thread only executes once. User threads have a lower priority than other routines.
- 8 Executive routines with a fixed interval time:
Similar to a PLC scan method, a thread will be created after the system starts that executes the user-defined routine in a fixed time interval (minimum 2 ms).
- Hardware interrupt routine:
EzProg-I processes DI signal interrupts and Motion interrupts to execute the code added to the interrupt service routine.

Other features of EzProg-I:

Public System Variable Type:	D (long), DW (Double WORD), W (Word), F (Float), B (Byte), M (Flag), S (Step), MSG (Message).
Retain Variable:	Most variable types have half-retain variable blocks.
Timer Function:	Millisecond-based timer.
Multi-language Messages:	A MLn file is provided to allow editing of UNICODE 1000 messages.

Tools Support Guide: EzConfig, EzGo

Module/Tool	EzConfig	EzGo
I-8092F-G	Yes (Note 1)	Yes
I-8094-G	-	Yes
I-8094F-G	Yes (Note 1)	Yes
I-8094A-G	-	Yes
I-8094H-G	-	Yes
I-8K Serial Modules	Yes	-
FRnet Remote Modules	Yes	-

Note 1: Only for FRnet

EzProg-I Tools



EzConfig

EzConfig is an I/O configuration tool that can be used to configure and test digital I/O, analog I/O, FRnet remote I/O and virtual I/O (M/D/F/DB/C/T/MSG etc.) for I-8000 series modules and the virtual I/O used in the EzProg-I.

Functions of EzConfig:

- Auto scan of I/O modules
- Load and save configuration data
- Retain data management
- Set initial virtual value
- Edit notes
- Read/Write XML files
- Generate AES code



EzGo

ICP DAS provides a motion testing tool called EzGo for I-8094, I-8094F, I-8094A, I-8094H and I-8092F modules used within PACs for machine automation.

EzHMI

EzProg-I also provides many useful HMI ActiveX components for manufacturers and control system designers. It allows the programmer to create a graphical interface on a WinCE system without requiring any additional programming, greatly improving application programming productivity.

- EzHMI for applications
- Easy property settings
- Easy GUI color settings
- UNICODE Multi-Language editing
- Auto alarm flashing
- Dynamic BMP images
- Direct I/O register value settings
- Support Windows text fonts
- Displays I/O register data



EzLib

EzLib is a collection of reusable software components that is designed to assist software developers when writing application programs for the Window CE platform.

- Data format transformation
- Date/Time functions
- File I/O functions
- BMP file drawing library
- FTP connection library
- TCP/IP library
- Trend graph library

MPAC (Motion PAC) Series

MP-8343 / MP-8743 / MP-8353 / MP-8753

2

1

PAC Solutions



NEW MP-8343



NEW MP-8743



Available soon MP-8353



Available soon MP-8753

Features:

- AMD LX800 500 MHz CPU or Atom Z510 1.1 GHz CPU
- Windows CE 6.0
- SQL Compact Edition 3.5
- EzProg-I development tools
- VGA Port Output
- Redundant Power Input
- Operating Temperature: -25 ~ +75°C



Introduction:

The **MP-8xx3** is part of the new generation of programmable automation controllers from ICP DAS. It is equipped with a Windows Embedded CE 6.0 operating system running on an AMD LX 800 CPU (500 MHz) or an Intel Atom Z510 CPU (1.1 GHz), and includes a wide range of interface ports (VGA, USB, Ethernet, RS-232/RS-485) and either 3 or 7 slots for connecting high performance parallel I/O modules (high profile I-8K series).

The Windows Embedded CE 6.0 OS has many advantages, including hard real-time capability, small core size, interrupt handling at a deeper level, achievable deterministic control and low cost. Compared with CE5.0, Windows Embedded CE6.0 automatically updates its virtual memory architecture to increase system robustness and security.

Application: Rich I/O Expansion Ability

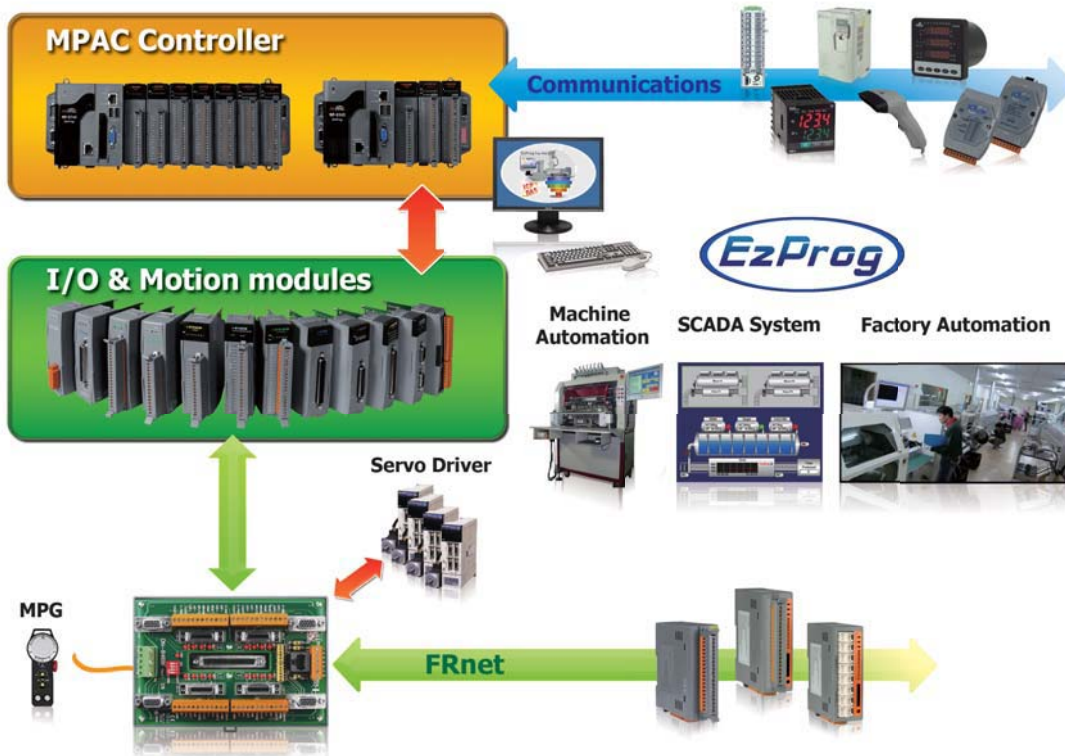

Hardware:

1. Appearance

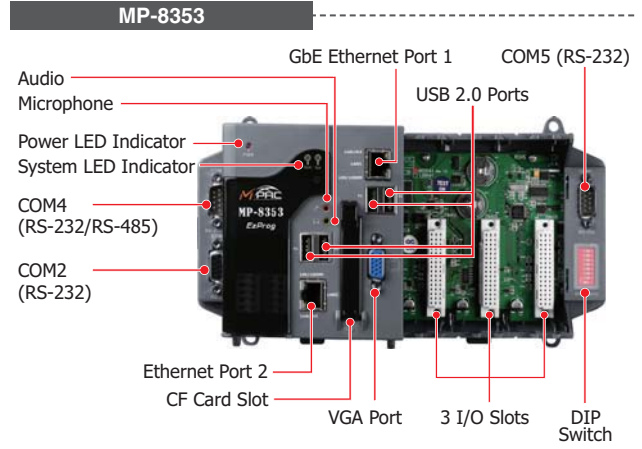
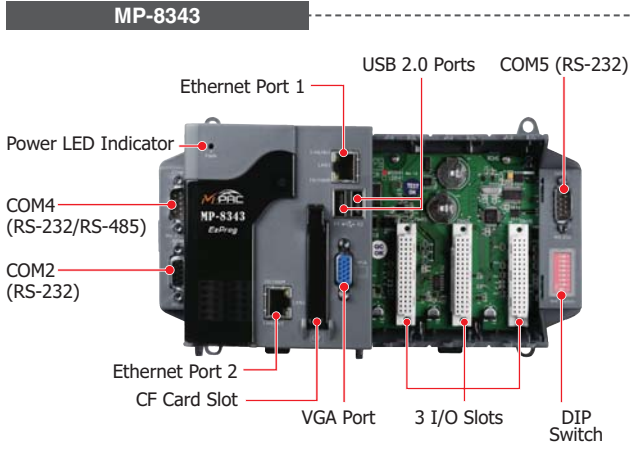

2. Installation



DIN-Rail Mounting

3. Mechanical

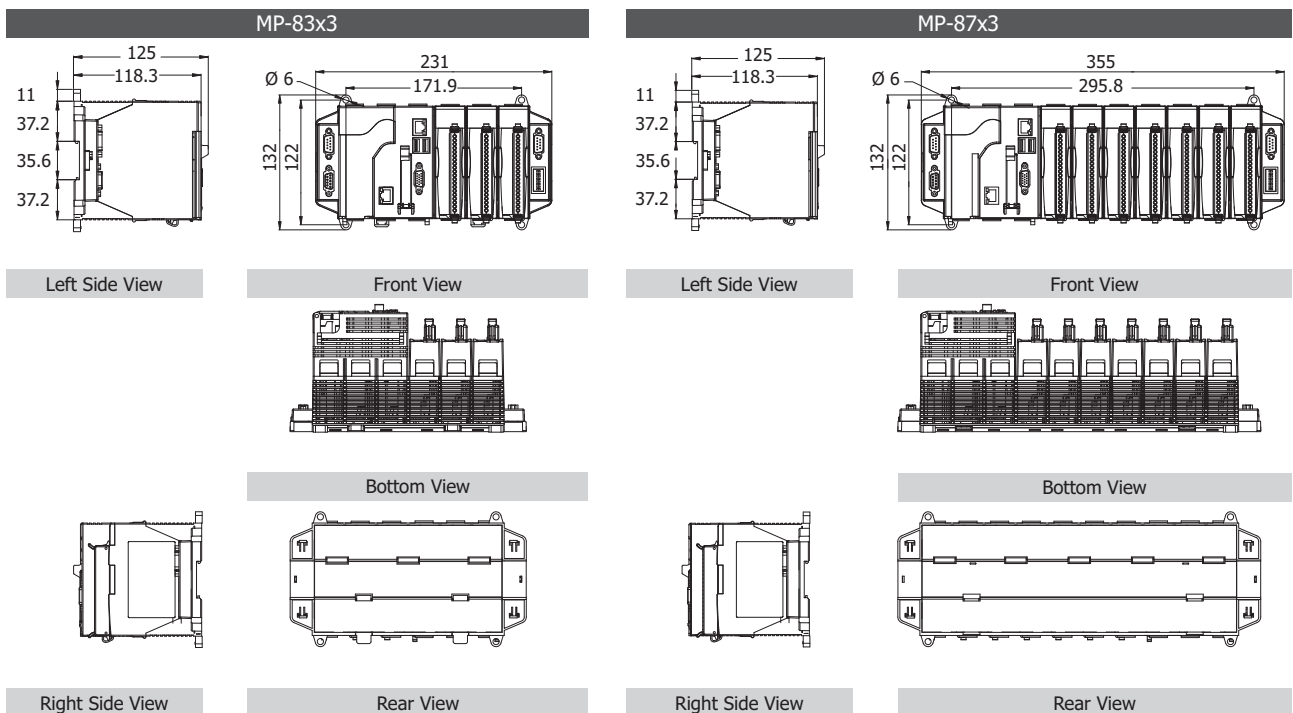

Specifications:

Models	MP-8343	MP-8743	MP-8353	MP-8753
System Software				
OS	Windows CE 6.0 core version			
.Net Compact Framework	3.5			
Embedded Services	FTP Server, ASP (Java Script, VB Script), SQL Compact Edition 3.5			
SDK Provided	DII for Visual Studio .Net 2005/2008			
Multilanguage Support	English, German, French, Spanish, Russian, Italian, Japanese, Simplified Chinese, Traditional Chinese			
CPU Module				
CPU	LX800, 500 MHz		Atom Z510, 1.1 GHz	
System Memory	512 MB DDR SDRAM			
Dual Battery Backup SRAM	512 KB; data valid up to 5 years			
Flash	4 GB		8 GB	
EEPROM	16 KB			
CF Card	Minimum 1 GB (support up to 32 GB)			
64-bit Hardware Serial Number	Yes, for Software Copy Protection			
Dual Watchdog Timers	Yes			
Rotary Switch	Yes (0 ~ 9)			
DIP Switch	Yes (8 bits)			
Audio	-		Microphone-In and Earphone-Out	
VGA & Communication Ports				
VGA	Yes (resolution: 1024 x 768, 800 x 600, 640 x 480)			
Ethernet (Giga bit)	RJ-45 x 2, 10/100 Base-TX (Auto-negotiating, Auto MDI/MDI-X, LED indicators)			
USB 2.0	2		4	
COM 1	Internal communication with I-87K modules in slots			
COM 2	RS-232 (RxD, TxD and GND); non-isolated			
COM 3	RS-485 (Data+, Data-) with internal self-tuner ASIC; 3000 VDC isolated			
COM 4	RS-232/RS-485 (RxD, TxD, CTS, RTS and GND for RS-232, Data+ and Data- for RS-485); non-isolated			
COM 5	RS-232 (RxD, TxD, CTS, RTS, DSR, DTR, CD, RI and GND); non-isolated			
I/O Expansion Slots				
Number of Slots	3	7	3	7
Type of Modules Supported	High profile modules only			
Mechanical				
Dimensions (W x L x H)	231 mm x 132 mm x 125 mm	355 mm x 132 mm x 125 mm	231 mm x 132 mm x 125 mm	355 mm x 132 mm x 111 mm
Installation	DIN-Rail or Wall Mounting			
Environmental				
Operating Temperature	-25 ~ +75°C			
Storage Temperature	-30 ~ +80°C			
Ambient Relative Humidity	10 ~ 90% RH, Non-condensing			
Power				
Input Range	+10 ~ +30 VDC			
Isolation	1 kV			
Redundant Power Inputs	Yes, with one power relay (1 A @ 24 VDC) for alarm			
Capacity	35 W			
Consumption	14.4 W	16.8 W	14.4 W	16.8 W

Ordering Information:

MP-8343 CR	Standard MP-8343 PAC with 3 I/O Slots (Multilingual OS) (RoHS)
MP-8743 CR	Standard MP-8743 PAC with 7 I/O Slots (Multilingual OS) (RoHS)
MP-8353 CR	Standard MP-8353-Atom PAC with 3 I/O Slots (Multilingual OS) (RoHS)
MP-8753 CR	Standard MP-8753-Atom PAC with 7 I/O Slots (Multilingual OS) (RoHS)

Accessories:

USB-2020 CR	USB Audio Device (RoHS)
USB-2560 CR	4-port Industrial USB 2.0 Hub (RoHS)
NS-208 CR	8-port Unmanaged Industrial 10/100 Base-TX Ethernet Switch (RoHS)
MDR-20-24 CR	24 V _{DC} /1.0 A, 24 W Power Supply with DIN-Rail Mounting (RoHS)
MDR-60-24 CR	24 V _{DC} /2.5 A, 60 W Power Supply with DIN-Rail Mounting (RoHS)

2.2 ISaGRAF+XPAC Motion Control Solutions



Introduction

As a pioneer of PAC, ICP DAS provides a new PAC motion control solution - ISaGRAF + XPAC Motion Control Solution. Integrating with the ISaGRAF development software and the Soft-GRAF HMI, the XPAC series plus the I-8094F/8094/8092F motion control solution allows users to easily design and implement a professional and user-friendly system with effective integration of motion controls, logic controls and I/O device controls.

Features

- ISaGRAF provides IEC 61131-3 standard PLC open Syntax: Motion control design is easy and professional.
- Using XPAC-CE6 is more effective than using PLC: Using XPAC-CE6 for motion control is more effective when integrating motion controls, logic controls and I/O controls.
- Support free Soft-GRAF HMI Software: The control logic via ISaGRAF & the HMI Screen via Soft-GRAF.

Motion Functions

- Independent 4-axis motion control
- Support manual pulse generator and jog functions
- 2/3-axis linear interpolation function
- 2-axis circular interpolation function
- Programmable T/S-curve acceleration and deceleration
- A maximum pulse output rate of 4M pps for each axis
- Pulse Output Types: CW/CCW or PULSE/DIR
- 32-bit encoder counter for each axis
- Encoder pulse input types: A/B phase or Up/Down
- Programmable automatic homing for each axis
- Position comparison management and software limits
- Expandable remote I/O: 128 DI and 128 DO via a two-wire FRnet interface
- Require low CPU loading for motion function processing
- Multiple motion modules can be used with a single XPAC-CE6 and the status of other I/O devices can be monitored at the same time

Development Software - Control Logic



The SoftLogic Solution: ISaGRAF

ISaGRAF is a powerful SoftLogic package on the industrial market. ISaGRAF Workbench is a PLC-like development software running on Windows 95, 98, NT, 2000, XP, Vista and Windows 7. Its ISaGRAF Runtime application programs can run on any ISaGRAF PACs such as ISaGRAF WinCE series (WP-8xx7/5xx7, VP-2xW7/4xx7, XP-8xx7-CE6/XP-8xx7-Atom-CE6) and ISaGRAF MiniOS7 series (VP-2117, iP-8xx7/I-8xx7, μPAC-7186EG, I-7188EG/XG, μPAC-5xx7) etc. Using ISaGRAF PACs, the control/monitor systems can easily implement industrial level of real-time data acquisition and data/devices control via wiring or wireless network in various industries.

ISaGRAF Workbench Features:

- Support IEC 61131-3 Standard Open PLC Languages (1~5)
 - + Flow Chart (FC):
 1. Quick Ladder (LD)
 2. Function Block Diagram (FBD)
 3. Sequential Function Chart (SFC)
 4. Structured Text (ST)
 5. Instruction List (IL)
 6. Flow Chart (FC)
- Online debug/control/monitor
- Offline simulation
- Online change (For ISaGRAF WinCE series only)
- Spotlight: Simple graphic HMI
- Auto-scan I/O
- Lock & unlock I/O
- Uploading the program in the PAC

ISaGRAF Solution Features:

- Support Soft-GRAF HMI
 - A free HMI software on the WinPAC, XPAC and ViewPAC
 - Soft-GRAF Studio: simple HMI screen editing (Mouse drag & drop)
- Modbus Master Protocol - RTU, ASCII, RS-232/485/422, TCP Master
- Modbus Slave Protocol - RTU (RS-232/485/422), TCP/IP Slave
- Data-Recorder & Data-Logger
- Data Exchange - Ebus (via Ethernet), Fbus (via RS-485), PAC to PAC
- CAN/CANopen - Via I-7530 to connect CAN/CANopen devices, ex. meters...
- FRnet I/O
- Motion Control: For controlling server motors (P-command)
- PAC can send email to the internet
- SMS: GSM modem, For reporting data and alarms to the operators
- Wireless Communication: GPS, ZigBee & Radio
- Auto-report Acquisition/Control Data
- Redundant Solution: Hot-swap/Ethernet
- Schedule-Control

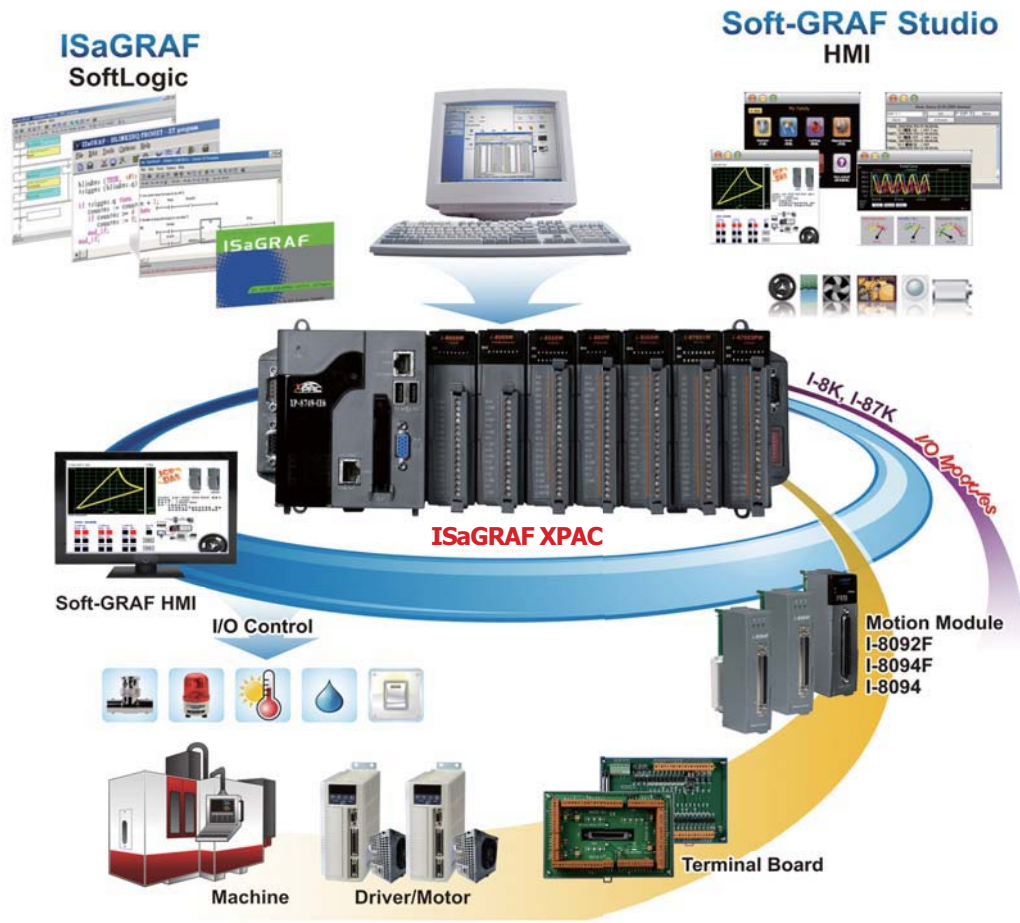

Development Software - HMI Screens

Free HMI Designer: Soft-GRAF Studio

Soft-GRAF Studio is an HMI (Human Machine Interface) software developed by ICP DAS which allows user to create his colorful HMI application running with the control logic in the same XP-8147-Atom-CE6/8347-Atom-CE6/8747-Atom-CE6, XP-8047-CE6/8347-CE6/8747-CE6, WP-8137/8437/8837, WP-8147/8447/8847, WP-5147/5147-OD and VP-25W7/23W7/4137 ISaGRAF PAC. User can edit the HMI screen by Soft-GRAF Studio using the graphical drag and drop operation. And use ISaGRAF to design the control logic by PLC Languages (Ladder, ST, FBD,

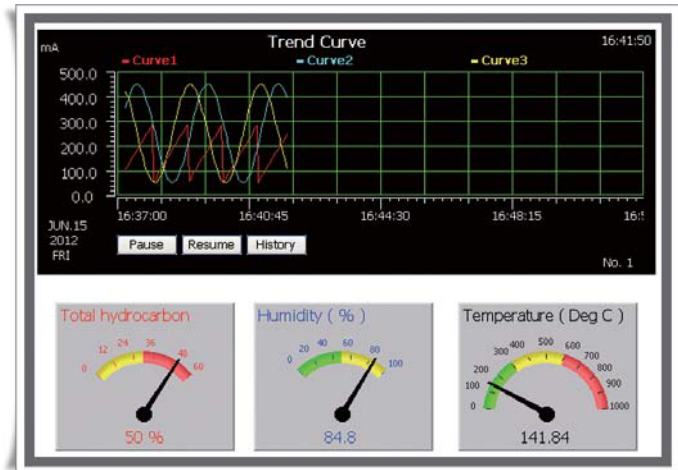

Soft-GRAF Features:

- Support Various and Colorful HMI Objects:
 - Pages (Max. 200, Support Password Security)
 - Label (Normal, Reverse Type, Under-line)
 - Boolean Value (Normal, Reverse Type, Blinking)
 - Numeric Value (Normal, Scaling, Limit - Blink/Color/Text)
 - Message Value (Dynamic Message, Multi-language)
 - Button (Value, Title, Picture, Security, Confir m, Password)
 - Picture (Static, Dynamic, Boolean Picture)
 - Login/Logout
 - Bar Meter (Vertical, Horizontal, Scale, Unipolar, Bipolar)
 - Trace (1-axis, 2-axis)
 - Trend (Real-time, Historical)
 - Schedule-Control
 - Gauge Meter
 - Alarm Lists
 - Data Logger (Log data; support USB export or FTP upload)
 - Built-in Various Objects (Button, Gif, LED... will be More)
- Multi-language:
 - English, Traditional Chinese, Simplify Chinese, Russian...
- Support user designed graphics, e.g. JPG, PNG ...



ISaGRAF XPAC Series

XP-8047-CE6 / XP-8347-CE6 / XP-8747-CE6



XP-8047-CE6



XP-8147-Atom-CE6



XP-8347-CE6



XP-8347-Atom-CE6



XP-8747-CE6



XP-8747-Atom-CE6

Features:

- XP-8x47-CE6: LX800, 500 MHz CPU
XP-8x47-Atom-CE6: Atom Z510, 1.1 GHz CPU
- Windows CE 6.0 R3 Core
- Embedded ISaGRAF Ver.3 SoftLogic (IEC 61131-3)
- Hard Real-time Capability
- VGA Port Output
- Modbus RTU/TCP (Master, Slave)
- Support Soft-GRAF HMI
- Redundant Power Inputs
- Support Motion Control Using I-8094F/8094/8092F
- Operating Temperature: -25 ~ +75°C



Introduction:

The **XP-8x47-CE6 Series** and **XP-8x47-Atom-CE6 Series** are the new generation of ISaGRAF based PACs from ICP DAS. Each is equipped with an AMD LX800 500 MHz CPU (for XP-8x47-CE6) or an Atom Z510 1.1 GHz CPU (for XP-8x47-Atom-CE6), a variety of input/output ports (VGA, USB, Ethernet, RS-232/485), and a range of I/O slots (0/3/7) that can be used to integrate high performance parallel I/O modules (high profile I-8K Series) or serial I/O modules (high profile I-87K series).

The benefits of running Windows CE 6.0 on an XPAC device include hard real-time capabilities, small core size, fast boot speed, interrupt handling at a deeper level, and achievable deterministic control. XPAC devices are also capable of running ISaGRAF and PC-based control software, such as Visual Basic .NET, Visual C#, etc., providing all of the best features of both traditional PLCs and Windows capable PCs.

ISaGRAF Features:

ISaGRAF is the most powerful SoftLogic package on the market, and is a PLC-like software suite application that supports IEC 61131-3 standard PLC programming languages (LD, FBD, SFC, ST, IL, FC). ISaGRAF can be used to execute applications generated by the ISaGRAF workbench on any ISaGRAF PAC. The features of the ISaGRAF workbench Ver. 3.x include:

- IEC 61131-3 Standard Open PLC Programming Languages (LD, FBD, SFC, ST, IL) + Flow Chart (FC)
- Auto-scan I/O
- Online Debug/Control/Monitor, Offline Simulation
- Simple Graphic HMI
- Support Soft-GRAF HMI

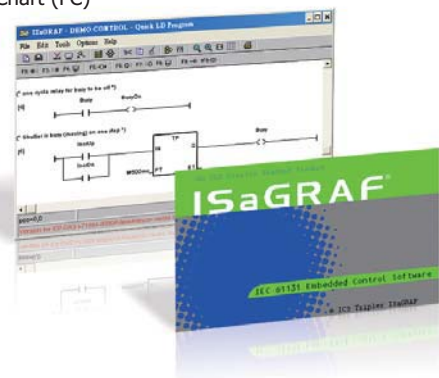
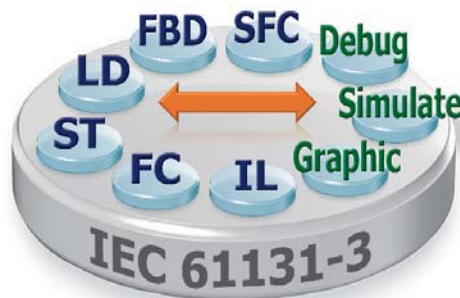

2

2

PAC Solutions

Applications:

Soft-GRAF Studio Colorful HMI



Schedule Control



Motion Control: Using I-8094F/8092F/8094



2G/3G Wireless Application

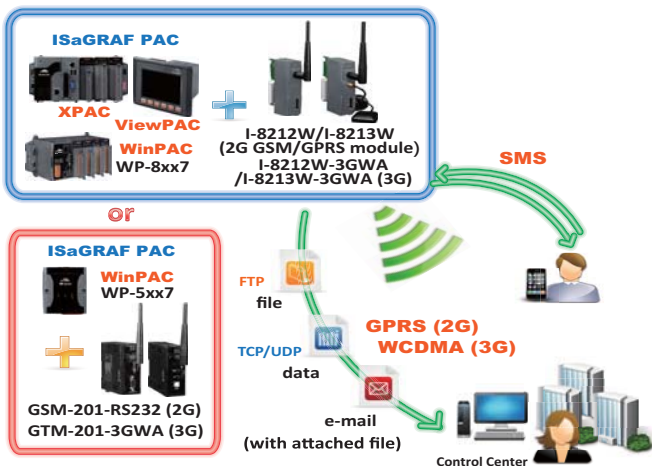

Modbus Master Ports

Modbus RTU/ASCII Master

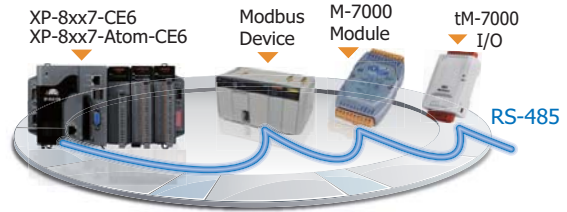

Modbus TCP/IP Master

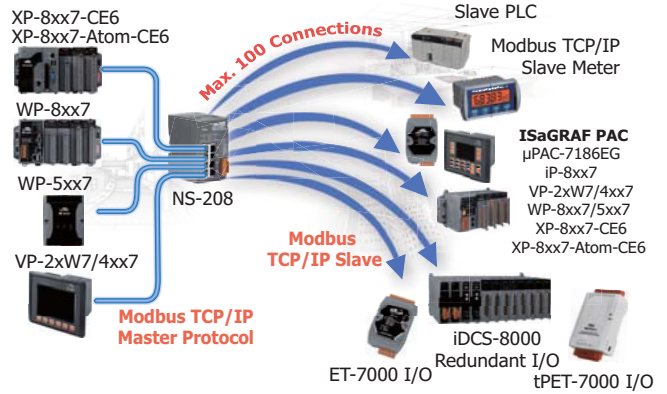

Hot-Swap Redundant System

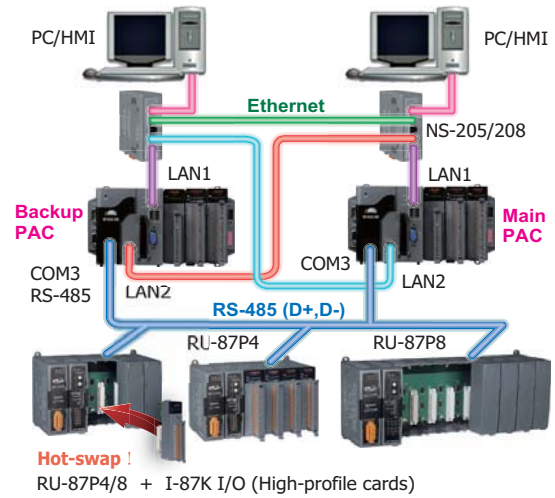

Modbus Slave : RTU / TCP

- Modbus RTU (RS-232/485/422) Slave: max. 9 ports
- Modbus TCP/IP Slave: max. 64 connections

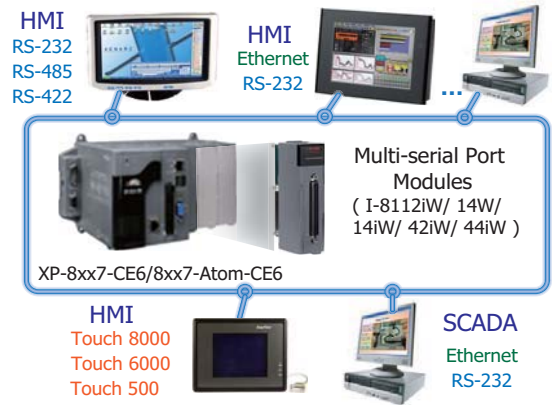

Specifications:

Models		XP-8047-CE6	XP-8347-CE6	XP-8747-CE6	XP-8147-Atom-CE6	XP-8347-Atom-CE6	XP-8747-Atom-CE6
System Software							
OS	Windows CE 6.0 R3 Core						
.Net Compact Framework	3.5						
Embedded Services	FTP Server, ASP (JavaScript, VB Script), SQL Compact Edition 3.5						
SDK Provided	DII for Visual Studio .Net 2005/2008						
Multilanguage Support	English, German, French, Spanish, Russian, Italian, Czech, Japanese, Korean, Simplified Chinese, Traditional Chinese						
Development Software							
ISaGRAF Software	ISaGRAF Ver.3	IEC 61131-3 standard					
	Language	LD, ST, FBD, SFC, IL & FC Support Soft-GRAF HMI: XP-8xx7-CE6, XP-8xx7-Atom-CE6, WP-8xx7/5xx7 and VP-2xW7/4xx7 PAC					
	Max. Code Size	2 MB					
	Scan Time	3 ~ 15 ms for normal programs 15 ~ 50 ms (or more) for complex or large programs					
Non-ISaGRAF	Options: VS.NET 2005/2008 (VB.NET, C#.NET)						
Web Service							
Web HMI	PC running Internet Explorer can monitor/control PAC via the Internet/modem						
Security	Web HMI supports three levels of username and password protection. (high/medium/low)						
CPU Module							
CPU	LX800, 500 MHz			Atom Z510, 1.1 GHz			
System Memory	512 MB DDR SDRAM						
Dual Battery Backup SRAM	512 KB; data valid for up to 5 years (for retaining variables)						
Flash	4 GB			8 GB			
EEPROM	16 KB						
CF Card	Yes, support up to 32 GB						
RTC (Real Time Clock)	Display seconds, minutes, hours, date, day of the week, month, year						
Programmable LED Indicator	-			2			
64-bit Hardware Serial Number	Yes, for Software Copy Protection						
Dual Watchdog Timers	Yes						
Rotary Switch	Yes (0 ~ 9)						
DIP Switch	-			Yes (8 bits)			
Audio	-			Microphone-In and Earphone-Out			
VGA & Communication Ports							
VGA	Yes (resolution: 1024 x 768, 800 x 600, 640 x 480)			Yes (resolution: 1400 x 1050, 1024 x 768, 800 x 600, 640 x 480)			
Ethernet	RJ-45 x 2, 10/100 Base-TX (Auto-negotiating, Auto MDI/MDI-X, LED indicators).						
USB 2.0	2			4			
COM 1	RS-232 (Rx/D, Tx/D and GND); Non-isolated	Internal communication with high-profile I-87K series modules in the slots					
COM 2	RS-232 (Rx/D, Tx/D and GND); non-isolated						
COM 3	RS-485 (Data+, Data-) with internal self-tuner ASIC; 3000 VDC isolated						
COM 4	RS-232/RS-485 (Rx/D, Tx/D, CTS, RTS and GND for RS-232, Data+ and Data- for RS-485); non-isolated						
COM 5	RS-232 (Rx/D, Tx/D, CTS, RTS, DSR, DTR, CD, RI and GND); non-isolated						
I/O Expansion Slots							
Number of Slots	0	3	7	1	3	7	
	Note: For High Profile I-8K and I-87K Modules Only						
Mechanical							
Dimensions (W x L x H)	137 x 132 x 125 (mm)	231 x 132 x 125 (mm)	355 x 132 x 125 (mm)	169 x 132 x 125 (mm)	231 x 132 x 125 (mm)	355 x 132 x 125 (mm)	
Installation	DIN-Rail or Wall Mounting						
Environmental							
Operating Temperature	-25 ~ +75°C						
Storage Temperature	-30 ~ +80°C						
Ambient Relative Humidity	10 ~ 90% RH (non-condensing)						
Power							
Input Range	+10 ~ +30 VDC						
Isolation	1 kV						
Redundant Power Inputs	Yes, with one power relay (1 A @ 24 VDC) for alarm						
Capacity	15 W	35 W	35 W	25 W	35 W	35 W	
Consumption	14.4 W	14.4 W	16.8 W	16.6 W	16.8 W	18 W	

2

2

PAC Solutions

ISaGRAF Specifications:

2
2

PAC Solutions

Protocols (Note that certain protocols require optional devices)		
Net ID		1 ~ 255, user-assigned via software.
Modbus TCP/IP Master		Link to a max. of 100 devices that support the Standard Modbus TCP/IP Slave protocol (FAQ-113)
Modbus RTU/ASCII Master		XP-8047-CE6: A max. of 33 ports (COM1 ~ 33) (*); Other ISaGRAF XPAC models: A max. of 32 ports (COM2 ~ 33) (*) (To connect to other Modbus Slave devices)
Modbus RTU Slave		A max. of 9 ports (XP-8047-CE6: COM1 ~ 33; Other ISaGRAF XPAC models: COM2 ~ 33) (*) (For connecting ISaGRAF, PC/HMI/OPC Server and HMI panels)
Modbus TCP/IP Slave		Two Ethernet ports each supporting the Modbus TCP/IP Slave protocol for connecting ISaGRAF and PC/HMI. The two ports support up to 64 connections. Note: If the PAC uses 1 connection to connect to the PC/HMI, it can connect to up to 64 PCs/HMIs; If the PAC uses 2 connections to connect to each PC/HMI, it can connect to up to 32 PCs/HMIs; If one of the Ethernet port malfunctions, the other one can still be used to connect to the PC/HMI.
Web HMI Protocol		Ethernet ports for connecting a PC running Internet Explorer.
User-defined Protocol		Custom protocols can be applied at COM2~33 (XP-8047-CE6 plus COM1) using Serial communication function blocks. (*)
I-7000 & I-87K RS-485 Remote I/O		One of COM3~4 supports I-7000 I/O modules, I-87K base + I-87K Serial I/O boards, or RU-87Pn + I-87K High Profile I/O boards as remote I/O. A max. of 255 I-7000/87K remote I/O modules can connect to one PAC.
M-7000 Series Modbus I/O		A max. of 32 RS-485 ports (XP-8047-CE6: max. 33) (*). Each port can connect to up to 32 M-7000 modules.
Modbus TCP/IP I/O		LAN2 supports ICP DAS Ethernet I/O: I-8KE4-MTCP and I-8KE8-MTCP. If LAN2 malfunctions, it will automatically switch to LAN1 to continuously work. (The IP address for LAN1 and LAN2 should be set in the same IP domain) (FAQ-042)
FRnet I/O		Enable a max. of 7 I-8172W boards in slot 1 ~ 7 to be used to connect to FRnet I/O modules, such as FR-2053, FR-2057, FR-32R, FR-32P. Each I-8172W board can link to a max. of 256 DI plus 256 DO channels. (FAQ-082, 154)
Send Email		Provide functions to send email with a single attached file via the Ethernet port.
Ebus		Used to exchange data between ICP DAS ISaGRAF Ethernet PACs via the Ethernet port. (LAN2 Port only)
SMS: Short Message Service		Either COM4 or COM5 can link to a GSM Modem to support SMS. The user can request data/control the controller via a cellular phone. The controller can also send data and alarms to the user's cellular phone. Optional GSM Modem: GTM-201-RS232 (850/900/1800/1900 GSM/GPRS External Modem)
MMICON/LCD		COM4 or COM5 supports the ICP DAS MMICON.
UDP Server & UDP Client: Exchange Message & Auto-report		LAN1 or LAN2 supports the UDP Server and UDP Client protocols allowing messages to be sent/received to/from a PC/HMI or other device. For example, data can be automatically reported to the InduSoft's RXTX driver.
TCP Client: Exchange Message & Auto-report		LAN1 or LAN2 supports the TCP Client protocol allowing messages to be sent/received to/from a PC/HMI or other device that supports the TCP server protocol.
GPRS/SMS		Enable the I-8212W (2G/3G) card allowing short messages to be sent/received to/from or to access a dial up connection to link to the Internet and using a GPRS connection to send an email or communicate with remote stations using the "FTP Client" (FAQ-151) or the "TCP Client"/"UDP Server"/"UDP Client" (FAQ-143) protocols.
SQL Client		Support for the SQL Client function that allows data to be written (or read from) a Microsoft SQL Server (2000 SP3, 2005, 2008).
Hot-swap and Redundant System (Will be available for XP-8xx7-Atom-CE6)		This redundant system has setup two "Active IP" address point to the active LAN1 and LAN2 ports always. One or more PC/HMI/SCADA can communicate with this redundant system via one of the two given active IP. So the PC/HMI/SCADA can access to the system easily without any notice about which PAC is currently active. Moreover, the new redundant system can integrate with the RU-87P4/87P8 Expansion Unit plus the I-87K high-profile I/O cards to support the hot-swap application. If the I/O card is damaged, the maintenance person just takes one good-card with same model number to hot-swap the damaged one without stopping this redundant system. (FAQ-138, 125)
CAN/CANopen		COM2 and COM4 ~ 33 (XP-8047-CE6 plus COM1) can connect to one I-7530 (converter: RS-232 to CAN) to support CAN/CANopen devices and sensors. One PAC supports a max. of 32 RS-232 ports to connect a max. of 32 I-7530. (*) (FAQ-086)
CANopen Master		Enable the I-8123W CANopen Master card used to connect to other CANopen Slave devices. (FAQ-145)
HART Solutions		Enable I-87H17W modules in slots 1 to 7 used to communicate with other HART devices.
FTP Client		Enable the FTP Client to upload files from the PAC to a remote FTP server on a PC. (FAQ-151) The Soft-GRAF g_Alarm and g_Logger1 HMI objects also support FTP Client. (FAQ-146)
Soft-GRAF HMI		Provide support for the Soft-GRAF HMI. The user can design the HMI screen using the Soft-GRAF Studio on the PC and then download it to the PAC to display the HMI on the PAC. (FAQ-146)
Optional I/O Functions (Refer to ISaGRAF PAC I/O Selection Guide for I/O Module list)		
PWM Output	High Speed PWM Module	I-7088, I-8088W, I-87088W: 8-ch PWM outputs, software support 1 Hz ~ 100 kHz (non-continuous), duty: 0.1~99.9%
	DO Module as PWM	8-ch max. 250 Hz max. For Off=2 & On=2 ms. Output square wave: Off: 2~32766 ms, On: 2 ~ 32766 ms. Optional DO Boards: I-8037W, 8041W, 8041AW, 8042W, 8050W, 8054W, 8055W, 8056W, 8057W, 8060W, 8063W, 8064W, 8068W, 8069W. (Relay Output boards cannot generate fast square wave)
Counter, Encoder, Frequency	Parallel DI Counter	8 ch. max. for 1 controller. Counter val: 32 bit. 250 Hz max. Min. ON & OFF width must >2 ms. Optional DI boards: I-8040W, 8040PW, 8042W, 8046W, 8048W, 8050W, 8051W, 8052W, 8053W, 8053PW, 8054W, 8055W, 8058W, 8063W.
	Serial DI Counter	Counter input: 100 Hz max. Counter value: 0 ~ 65535 (16 bit) Optional Serial I-87K DI boards: I-87040W, 87046W, 87051W, 87052W, 87053W, 87053W-A5, 87054W, 87055W, 87058W, 87059W, 87063W.
	Remote DI Counter	All remote I-7K/I-87K DI modules support counters. 100 Hz max. value: 0 ~ 65535
	High Speed Counter	I-87082W: 100 kHz max., 32-bit; I-8084W: 250 kHz max., 32-bit
	Encoder	I-8093W: 3-axis Encoder Module, max. 1M Hz for quadrant input mode, max. 4 MHz for pulse/direction and cw/ccw input mode. (FAQ-112) I-8084W: 250 kHz max., 4-ch encoder, pulse/direction or up/down or A/B phase (Quad. mode). Not support Encoder Z-index. (FAQ-100)
Motion	Motion Control	Can be integrated with one or several I-8092F (2-axis) or I-8094F/I-8094 (4-axis). (XP-8047-CE6 not supported)
<p>* Note: The COM6 ~ COM33 ports are located in the expansion boards if they are installed in slots 1~7 of ISaGRAF XPAC. The COM1 port on XP-8047-CE6 is RS-232; COM1 on other ISaGRAF XPAC is for internal communication with I-87K modules installed in slots only.</p> <p>* ISaGRAF FAQ: www.icpdas.com > Support > FAQ > ISaGRAF Soft-Logic PAC</p> <p>* ICP DAS recommends using NS-205/208 or RS-405/408 (Ring Switch) Industrial Ethernet Switches.</p>		

Appearance:

XP-8047-CE6

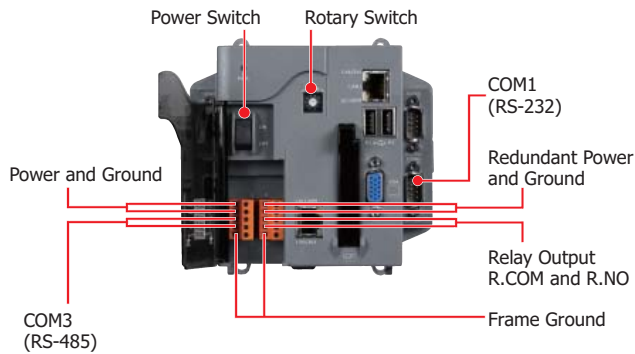

XP-8347-CE6

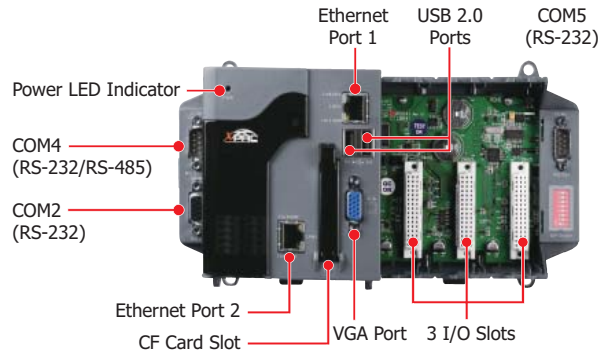

XP-8747-Atom-CE6

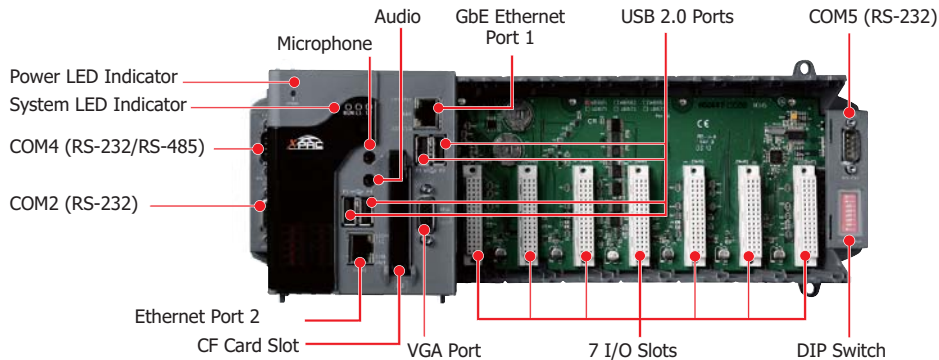

Ordering Information:

XP-8047-CE6 CR	0 I/O slot WinCE 6.0 Based ISaGRAF PAC (OS: Multi-Language version) (RoHS)
XP-8347-CE6 CR	3 I/O slots WinCE 6.0 Based ISaGRAF PAC (OS: Multi-Language version) (RoHS)
XP-8747-CE6 CR	7 I/O slots WinCE 6.0 Based ISaGRAF PAC (OS: Multi-Language version) (RoHS)
XP-8147-Atom-CE6 CR	1 I/O slot WinCE 6.0 Based Standard XPAC (OS: Multi-Language version) (RoHS)
XP-8347-Atom-CE6 CR	3 I/O slots WinCE 6.0 Based Standard XPAC (OS: Multi-Language version) (RoHS)
XP-8747-Atom-CE6 CR	7 I/O slots WinCE 6.0 Based Standard XPAC (OS: Multi-Language version) (RoHS)
Note: Call to discuss your needs for customized XP-8000-Atom-CE6 modules	

Accessories:

ISaGRAF Development Software	
ISaGRAF-256	ISaGRAF Workbench Software Ver.3 (256 I/O Tags) with one USB Dongle
ISaGRAF-32	ISaGRAF Workbench Software Ver.3 (32 I/O Tags)
Note: No upgrade service from ISaGRAF-32 to ISaGRAF-256 is available. (ISaGRAF-32 can be used to control more than 32 I/O tags. Please refer to Ch. 3.4 of the ISaGRAF User Manual.)	
DP-660	24 VDC/2.5 A, 60 W and 5 VDC/0.5 A, 2.5 W Power Supply with DIN-Rail Mounting
DP-1200 CR	24 VDC/5.0 A, 120 W Power Supply with DIN-Rail Mounting (RoHS)
MDR-60-24 CR	24 VDC/2.5 A, 60 W Power Supply with DIN-Rail Mounting (RoHS)
NS-205 CR / NS-208 CR	5-port/8-port Unmanaged Industrial 10/100 Ethernet Switch with Plastic Case (RoHS)
RS-405 CR / RS-408 CR	5-port 8-port Real-time Redundant Ring Switch (RoHS)
TPM-4100/TP-4100	10.4" (800 x 600) Resistive Touch Panel Monitor with RS-232 or USB Interface Accessories: VGA Cable, RS-232 Cable, USB Cable, Mounting Clamps and Screws

2

2

PAC Solutions



2.3 Motion Modules for PAC

I-8000 Motion Control Modules For PAC Motion Control:

Models	Encoder Input				Command Pulse Output				Daughter Board	Isolation Voltage	Other Functions	Support PAC
	Axis	Counter (bits)	Input Rate (pps)	Signal	Axis	Speed (pps)	Counter (bits)	Signal				
I-8092F-G	2	32	1 M	CW/CCW, A/B	2	4 M	32	CW/CCW, PULSE/DIR	DN-8237	2500 Vrms	FRnet Master	MPAC ISaGRAF XPAC
I-8094-G	4	32	1 M	CW/CCW, A/B	4	4 M	32	CW/CCW, PULSE/DIR	DN-8468	2500 Vrms	-	MPAC ISaGRAF XPAC
I-8094F-G	4	32	1 M	CW/CCW, A/B	4	4 M	32	CW/CCW, PULSE/DIR	DN-8468	2500 Vrms	FRnet Master	MPAC ISaGRAF XPAC
I-8094A-G	4	32	1 M	CW/CCW, A/B	4	4 M	32	CW/CCW, PULSE/DIR	DN-8468	2500 Vrms	CPU Inside	MPAC
I-8094H-G	4	32	1 M	CW/CCW, A/B	4	4 M	32	CW/CCW, PULSE/DIR	DN-8468	2500 Vrms	FRnet Master, CPU Inside	MPAC

PAC I-8000 DI/DO AI/AO High Profile Modules Selection Guide:

Analog Input Modules:

Model	Analog Input					Isolation Voltage	Voltage Overload Protection	Power Consumption
	Resolution	Input Channels	Sampling Rate	Voltage Input	Current Input			
I-8017HW	14 bit	8 diff.	100 KHz (total)	+/-10 V, +/-5 V +/-2.5 V, +/-1.25 V	+/-20 mA	3000 Vrms	+/-35 V	2 W

Analog Output Modules:

Models	Analog Output				Voltage Output Driver	Accuracy	Isolation Voltage	Power Consumption
	Resolution	Output Channels	Voltage Output	Current Output				
I-8024W	14 bit	4	+/-10 V	0-20 mA	5 mA max.	±0.1% of FSR	3000 V	2 W

Digital I/O Modules:

Models	Digital Input Channels	Digital Output Channels	LED Display	Power Consumption
I-8037W	-	16 (Open Source) / Isolation 3750 V	Yes	0.9 W
I-8040W	32 (Sink/Source) / Isolation 3750 V	-	Yes	0.65 W
I-8040PW	32 (Sink/Source) / Isolation 3750 V	-	Yes	1 W
I-8041W	-	32 (Open-collector) / Isolation 3750 V	Yes	1.5 W
I-8041AW	-	32 (Open-collector) / Isolation 3750 V	Yes	1.5 W
I-8042W	16 (Sink/Source) / Isolation 3750 V	16 (Open-collector) / Isolation 3750 V	Yes	1.5 W
I-8048W	8 (Sink/Source) / Isolation 1500 V	-	Yes	1.75 W
I-8051W	16 (Source) / Non-isolated	-	Yes	1.1 W
I-8052W	8 (Differential) / Isolation 5000 V	-	Yes	0.3 W
I-8053W	16 Isolation 3750 V	-	Yes	0.4 W
I-8053PW	16 (Sink/Source) / Isolation 3750 V with Low Pass Filter	-	Yes	0.45 W
I-8054W	8 (Sink/Source) / Isolation 3750 V	8 (Open-collector) / isolation 3750 V	Yes	0.55 W
I-8055W	8 (Source) / Non-isolated	8 (Open-collector) / Non-isolated	Yes	1 W
I-8056W	-	16 (Open-collector) / Non-isolated	Yes	0.9 W
I-8057W	-	16 (Open-collector) / Isolation 3750 V	Yes	0.9 W
I-8058W	8 AC/DC 250 V max. / Isolation 5000 V	-	Yes	0.6 W
I-8060W	-	6 / (Power Relay Form C)	Yes	1 W
I-8063W	4 (Sink/Source) / Isolation 3750 V	4 / (Power Relay Form C)	Yes	2 W
I-8064W	-	8 / (Power Relay Form A)	Yes	1.1 W
I-8068W	-	8 (Power Relay Form A x 4 Form C x 4)	Yes	2.5 W
I-8069W	-	8 (PhotoMos Relay Form A x 8)	Yes	0.6 W
I-8172W	FRnet Master. Up to 256 DI or 256 DO channels can be added using remote modules		Yes	2 W

I-8092F-G

High-speed 2-axis Motion Control Module with FRnet Master



Features:

- Independent 2-axis motion control
- Support for hand wheel and jog functions
- 2-axis linear / 2-axis circular interpolation function
- Continuous interpolation function
- Programmable T/S-curve acceleration and deceleration
- A maximum pulse output rate of 4 Mpps for each axis
- Pulse Output Types: CW/CCW or PULSE/DIR
- 32-bit encoder counter for each axis
- Encoder Pulse Input Types: A/B Phase or Up/Down
- Programmable automatic homing for each axis
- Programmable software limits
- Expandable Remote I/O: 128 DI and 128 DO via a two-wire FRnet interface

Introduction:

The **I-8092F** is a **2-axis** stepping/pulse-type servo motor control module that can be used on any of the ICP DAS I-8000 and PAC series controllers, and is suitable for general-purpose motion control applications. The I-8092F is equipped with one FRnet master, which allows fast remote I/O to be easily expanded. The two-wire FRnet interface can be used automatically scan its 128 DI and 128 DO channels with a scan period of 2.88 ms.

In addition to its wide speed range, this intelligent motion controller also has a variety of motion control functions built in, such as 2-axis linear interpolation, 2-axis circular interpolation, T/S-curve acceleration/deceleration, and others. A major advantage is that the majority of the I-8092F motion control functions are performed by the high-performance motion ASIC with little load on the processor. While driving the motors, the motion status, and the status of the other I/O channels on the I-8000 or PAC modules, can still be monitored.

As a result of the low CPU loading requirements of the I-8092F, one or more motion modules may be used on a single I-8000 or PAC controller. ICP DAS provides a wide range of functions and examples that can be used to reduce the need for programming by users, making it a highly cost-effective solution for motion control application developers.

Specifications:

Number of Axes	2
Maximum Pulse Output Rate	4 MHz
Command Type	Pulse command
Resolution	32-bit
Pulse Output Mode	CW/CCW, PULSE/DIR
Operation Mode	Semi-closed Loop
Linear Interpolation	2 axes
Circular Interpolation	2 axes
Speed Curve Profile	T/S curve
Motion Relative I/O	Home, LMT+/-, NHOME, EMG, INP, ALM, SVON
Synchronous Action	-
Ring Counter Mode	32-bit
Position Control Mode	Incremental mode
Position Compare Trigger	-
Encoder Interface	A/B pulse, Up/Down
Encoder Counter	32-bit
Encoder Rate	4 MHz
Digital Input Channels	Expandable: 128 DI
Digital Output Channels	Expandable: 128 DO
I/O Isolation (with DN-8237)	2500 Vrms optical isolation
Connector	37-pin D-sub
Power Consumption	+5 V @ 500 mA
Environmental	
Operating Temperature	-20 ~ +75°C
Storage Temperature	-30 ~ +85°C
Ambient Relative Humidity	5 ~ 90% RH, non-condensing

2

3

PAC Solutions

Features of Motion Function:

2-Axis Linear Interpolation

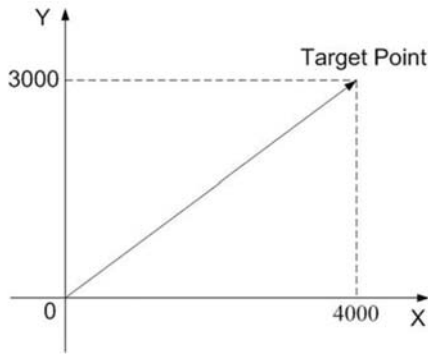

2-Axis Circular Interpolation

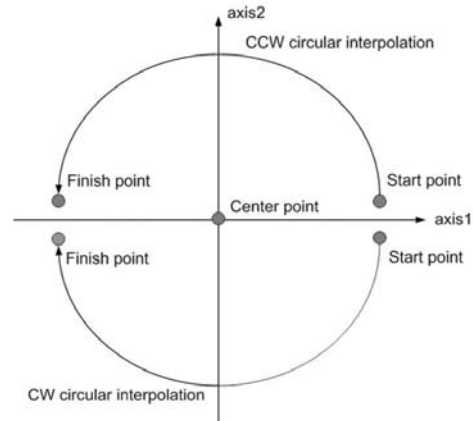

Continuous interpolation

8 Segments Continuous Interpolation Motion (Linear+ Circular)

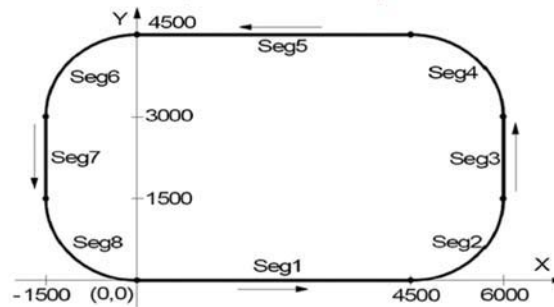

4 Steps Automatic Home Searching

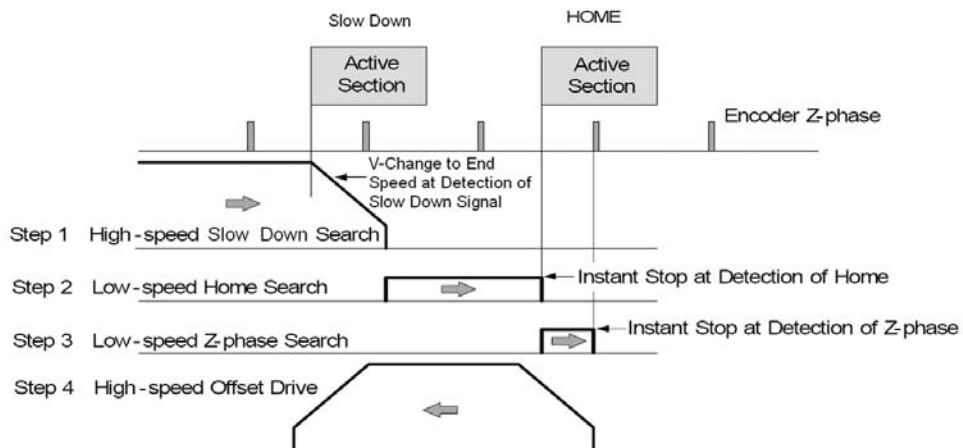

Ordering Information/Accessories:

Module	Description
I-8092F-G	High-speed 2-axis Motion Control Module with FRnet Master
DN-8237UB	Photo-isolated Universal Snap-on Wiring Terminal Board
DN-8237GB	Photo-isolated General Purpose Wiring Terminal Board
DN-8237MB	Photo-isolated Snap-on Wiring Terminal Board for Mitsubishi MELSERVO-J2 Servo Amplifier
DN-8237PB	Photo-isolated Snap-on Wiring Terminal Board for Panasonic MINAS A4/A5 Servo Amplifier
DN-8237YB	Photo-isolated Snap-on Wiring Terminal Board for Yaskawa Sigma II/III/V Servo Amplifier
DN-8237DB	Photo-isolated Snap-on Wiring Terminal Board for Delta ASDA-A Servo Amplifier
CA-3715DM-H / CA-3730DM-H / CA-3750DM-H	37-pin D-Sub Male-Male Cable for Terminal Board (180°), Length 1.5 M / 3.0 M / 5.0 M

I-8094-G

High-speed 4-axis Motion Control Module



Features:

- Independent 4-axis motion control
- Support for hand wheel and jog functions
- 2/3-axis linear / 2-axis circular interpolation function
- Continuous interpolation function
- Programmable T/S-curve acceleration and deceleration
- A maximum pulse output rate of 4 Mpps for each axis
- Pulse Output Types: CW/CCW or PULSE/DIR
- 32-bit encoder counter for each axis
- Encoder Pulse Input Types: A/B Phase or Up/Down
- Programmable automatic homing for each axis
- Position comparison management and software limits
- A wide range of synchronous actions (event-triggered actions)

Introduction:

The **I-8094** is a **4-axis** stepping/pulse-type servo motor control module that can be used on any of the ICP DAS I-8000 and PAC series controllers, and is suitable for general-purpose motion applications. In addition to its wide speed range, this intelligent motion controller also has a variety of motion control functions built in, such as 2/3-axis linear interpolation, 2-axis circular interpolation, T/S-curve acceleration/deceleration, a range of synchronous actions, automatic homing, and others.

A major advantage is that the majority of the I-8094 motion control functions are performed by the high-performance motion ASIC with little load on the processor. While driving the motors, the motion status, and the status of other I/O channels on the I-8000 or PAC modules, can still be monitored. As the CPU loading requirements of the I-8094 is minimal, one or more motion modules may be used with a single I-8000 or PAC controller. ICP DAS also provides a wide range of functions and examples that can be used to reduce the need for additional programming, making it a highly cost-effective solution for motion control application developers.

Specifications:

Number of Axes	4
Maximum Pulse Output Rate	4 MHz
Command Type	Pulse Command
Resolution	32-bit
Pulse Output Mode	CW/CCW, PULSE/DIR
Operation Mode	Semi-closed Loop
Linear Interpolation	Any 2 to 3 of 4 axes
Circular Interpolation	Any 2 axes
Speed Curve Profile	T/S-curve
Motion Relative I/O	Home, LMT+/-, NHOME, EMG, INP, ALM, SVON
Synchronous Action	10 activation factors and 14 actions
Ring Counter Mode	32-bit
Position Control Mode	Incremental mode and absolute mode
Position Compare Trigger	10 KHz
Encoder Interface	A/B pulse, Up/Down
Encoder Counter	32-bit
Encoder Rate	4 MHz
Digital Input Channels	-
Digital Output Channels	-
I/O Isolation (with DN-8468)	2500 Vrms optical isolation
Connector	68-pin SCSI-II connector
Power Consumption	+5 V @ 500 mA
Environmental	
Operating Temperature	-20 ~ +75°C
Storage Temperature	-30 ~ +85°C
Ambient Relative Humidity	5 ~ 90% RH, non-condensing

2

3

PAC Solutions

Features of Motion Function:

2 or 3-Axis Linear Interpolation

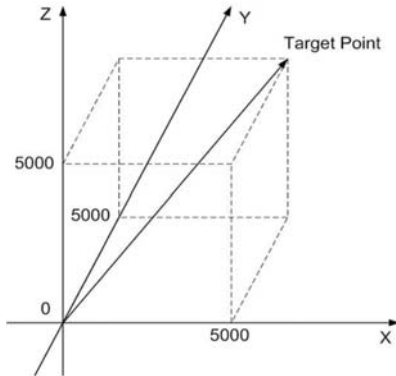

2-Axis Circular Interpolation

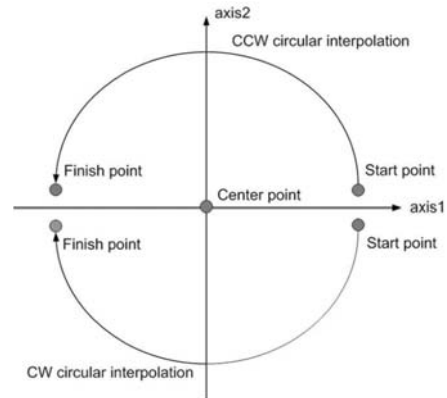

Continuous interpolation

8 Segments Continuous Interpolation Motion (Linear+ Circular)

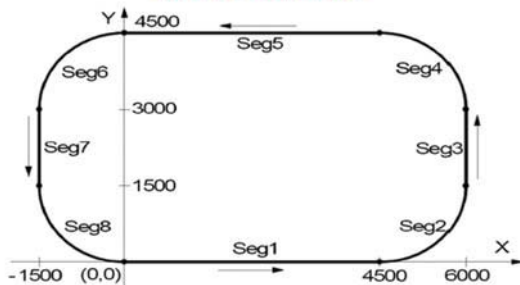

High Speed Position Compare

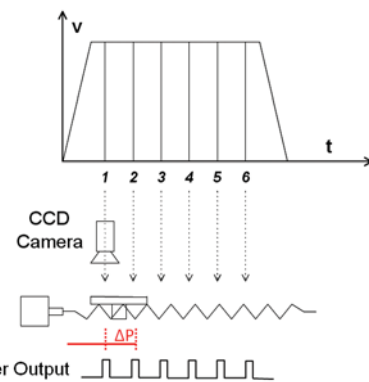

4 Steps Automatic Home Searching

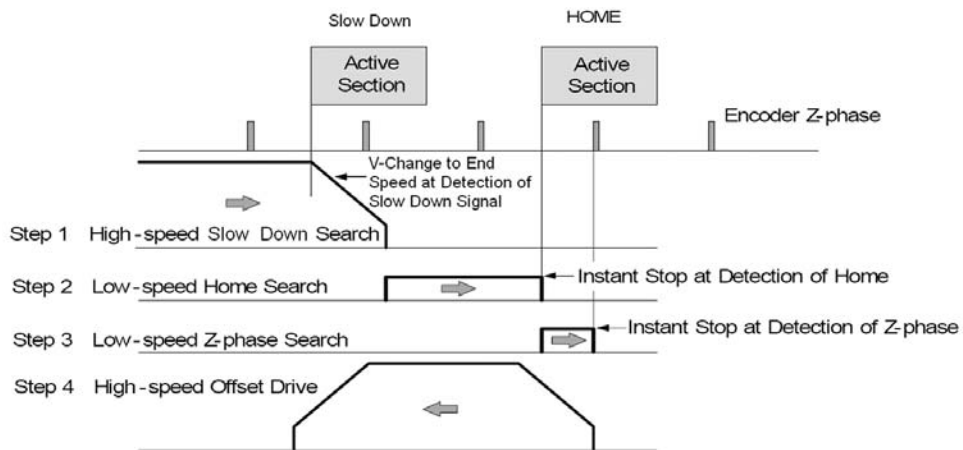

Ordering Information/Accessories:

Module	Description
I-8094-G	High-speed 4-axis Motion Control Module
DN-8468UB	Photo-isolated Universal Snap-on Wiring Terminal Board
DN-8468GB	Photo-isolated General Purpose Wiring Terminal Board
DN-8468MB	Photo-isolated Snap-on Wiring Terminal Board for Mitsubishi MELSERVO-J2 Servo Amplifier
DN-8468PB	Photo-isolated Snap-on Wiring Terminal Board for Panasonic MINAS A4/A5 Servo Amplifier
DN-8468YB	Photo-isolated Snap-on Wiring Terminal Board for Yaskawa Sigma II/III/IV Servo Amplifier
DN-8468DB	Photo-isolated Snap-on Wiring Terminal Board for Delta ASDA-A Servo Amplifier
DN-8468FB	Photo-isolated Snap-on Wiring Terminal Board for Fuji FALDIC-W Servo Amplifier
CA-SCSI15-H / CA-SCSI30-H / CA-SCSI50-H	68-pin SCSI-II Male-Male Connector Cable, Length 1.5 M / 3.0 M / 5.0 M

2
3

PAC Solutions

I-8094F-G

High-speed 4-axis Motion Control Module with FRnet Master



CE FC

Features:

- Independent 4-axis motion control
- Support for hand wheel and jog functions
- 2/3-axis linear / 2-axis circular interpolation function
- Continuous interpolation function
- Programmable T/S-curve acceleration and deceleration
- A maximum pulse output rate of 4 Mpps for each axis
- Pulse Output Types: CW/CCW or PULSE/DIR
- 32-bit encoder counter for each axis
- Encoder Pulse Input Types: A/B Phase or Up/Down
- Programmable automatic homing for each axis
- Position comparison management and software limits
- A wide range of synchronous actions (event-triggered actions)
- Expandable Remote I/O: 128 DI and 128 DO via a two-wire FRnet interface

Introduction:

The **I-8094F** is a **4-axis** stepping/pulse-type servo motor control module that can be used on any of the ICP DAS I-8000 and PAC series controllers, and is suitable for general-purpose motion applications. The I-8094F has the full functions of the I-8094 with the addition of an FRnet port, which allows the fast remote I/O of the module to be expanded easily. This two-wired FRnet can automatically scan its 128 DI and 128 DO channels within a period of 2.88 ms.

In addition to its wide speed range, this intelligent motion controller also has a variety of motion control functions built in, such as 2/3-axis linear interpolation, 2-axis circular interpolation, T/S-curve acceleration/deceleration, numerous synchronous actions, automatic homing, and others. A major advantage is that the majority of the I-8094F motion control functions are performed by the high-performance motion ASIC with little load on the processor. While driving the motors, the motion status, and the status of the other I/O channels on the I-8000 or PAC modules, can still be monitored.

As the CPU loading requirements of the I-8094F is minimal, one or more motion modules may be used with a single I-8000 or PAC controller. ICP DAS also provides a wide range of functions and examples that can be used to reduce the need for additional programming, making it a highly cost-effective solution for motion control application developers.

Specifications:

Number of Axes	4
Maximum Pulse Output Rate	4 MHz
Command Type	Pulse Command
Resolution	32-bit
Pulse Output Mode	CW/CCW, PULSE/DIR
Operation Mode	Semi-closed Loop
Linear Interpolation	Any 2 to 3 of 4 axes
Circular Interpolation	Any 2 axes
Speed Curve Profile	T/S-curve
Motion Relative I/O	Home, LMT+/-, NHOME, EMG, INP, ALM, SVON
Synchronous Action	10 activation factors and 14 actions
Ring Counter Mode	32-bit
Position Control Mode	Incremental mode and absolute mode
Position Compare Trigger	10 KHz
Encoder Interface	A/B pulse, Up/Down
Encoder Counter	32-bit
Encoder Rate	4 MHz
Digital Input Channels	Expandable : 128 DI
Digital Output Channels	Expandable : 128 DO
I/O Isolation (With DN-8468)	2500 Vrms optical isolation
Connector	68-pin SCSI-II connector
Power Consumption	+5 V @ 500 mA
Environmental	
Operating Temperature	-20 ~ +75°C
Storage Temperature	-30 ~ +85°C
Ambient Relative Humidity	5 ~ 90% RH, non-condensing

2

3

PAC Solutions

Features of Motion Function:

2 or 3-Axis Linear Interpolation

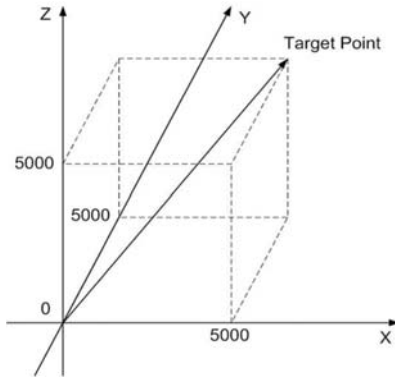

2-Axis Circular Interpolation

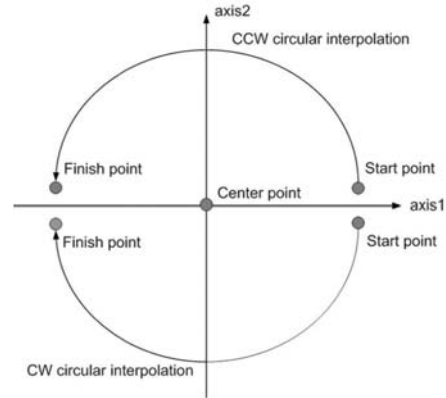

Continuous interpolation

8 Segments Continuous Interpolation Motion (Linear+ Circular)

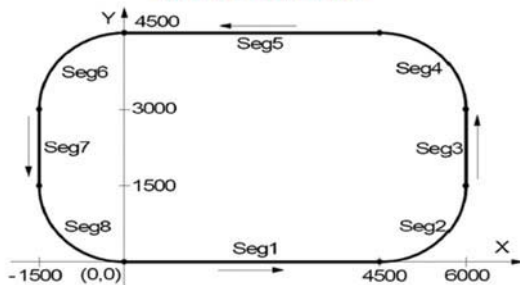

High Speed Position Compare

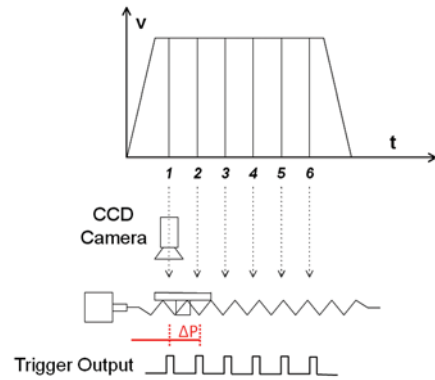

4 Steps Automatic Home Searching

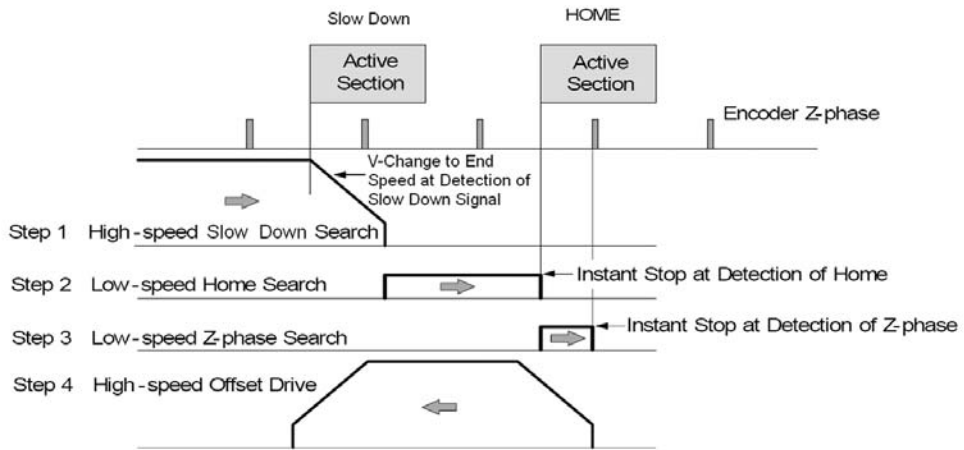

Ordering Information/Accessories:

Module	Description
I-8094F-G	High-speed 4-axis Motion Control Module with FRnet Master
DN-8468UB	Photo-isolated Universal Snap-on Wiring Terminal Board
DN-8468GB	Photo-isolated General Purpose Wiring Terminal Board
DN-8468MB	Photo-isolated Snap-on Wiring Terminal Board for Mitsubishi MELSERVO-J2 Servo Amplifier
DN-8468PB	Photo-isolated Snap-on Wiring Terminal Board for Panasonic MINAS A4/A5 Servo Amplifier
DN-8468YB	Photo-isolated Snap-on Wiring Terminal Board for Yaskawa Sigma II/III/V Servo Amplifier
DN-8468DB	Photo-isolated Snap-on Wiring Terminal Board for Delta ASDA-A Servo Amplifier
DN-8468FB	Photo-isolated Snap-on Wiring Terminal Board for Fuji FALDIC-W Servo Amplifier
CA-SCSI15-H / CA-SCSI30-H / CA-SCSI50-H	68-pin SCSI-II Male-Male Connector Cable, Length 1.5 M / 3.0 M / 5.0 M

2
3

PAC Solutions

I-8094A-G

High-speed 4-axis Motion Control Module with Internal CPU



Introduction:

The **I-8094A** is a **4-axis** stepping/pulse-type servo motor control module that can be used on any of the ICP DAS PAC series controllers, and is suitable for general-purpose motion applications. The I-8094A has the full functions of the I-8094 and has an internal 80186 CPU allowing the module to be used to perform additional functions, including the ability to perform motion operations without requiring a PAC. When working with a PAC, it also allows users to perform additional functions by calling user-defined subroutines (Macro functions). Users can embed their customized processes (know-how) inside this module.

In addition to its wide speed range, this intelligent motion controller also has a variety of motion control functions built in, such as 2/3-axis linear interpolation, 2-axis circular interpolation, T/S-curve acceleration/deceleration, numerous synchronous actions, automatic homing, and others. A major advantage is that the majority of the I-8094A motion control functions are performed by the high-performance motion ASIC with little load on the processor. While driving the motors, the motion status, and the status of the other I/O channels on the PAC modules, can still be monitored.

As the CPU loading requirements of the I-8094A is minimal, one or more motion modules may be used with a single PAC controller. ICP DAS also provides a variety of functions, and examples that can be used to reduce the need for additional programming by users, making it a highly cost-effective solution for motion control application developers.

Features:

- Independent 4-axis motion control
- Support for hand wheel and jog functions
- 2/3-axis linear / 2-axis circular interpolation function
- Continuous interpolation function
- Programmable T/S-curve acceleration and deceleration
- A maximum pulse output rate of 4 Mpps for each axis
- Pulse Output Types: CW/CCW or PULSE/DIR
- 32-bit encoder counter for each axis
- Encoder Pulse Input Types: A/B Phase or Up/Down
- Programmable automatic homing for each axis
- Position comparison management and software limits
- A wide range of synchronous actions (event-triggered actions)
- Can operate as a standalone module or in conjunction with a PAC

Specifications:

Number of Axes	4
Maximum Pulse Output Rate	4 MHz
Command Type	Pulse Command
Resolution	32-bit
Pulse Output Mode	CW/CCW, PULSE/DIR
Operation Mode	Semi-closed Loop
Linear Interpolation	Any 2 to 3 of 4 axes
Circular Interpolation	Any 2 axes
Speed Curve Profile	T/S-curve
Motion Relative I/O	Home, LMT+/-, NHOME, EMG, INP, ALM, SVON'
Synchronous Action	10 activation factors and 14 actions
Ring Counter Mode	32-bit
Position Control Mode	Incremental mode and absolute mode
Position Compare Trigger	10 KHz
Encoder Interface	A/B pulse, Up/Down
Encoder Counter	32-bit
Encoder Rate	4 MHz
Digital Input Channels	-
Digital Output Channels	-
I/O Isolation(with DN-8468)	2500 Vrms optical isolation
Connector	68-pin SCSI-II connector
Power Consumption	+5 V @ 500 mA
Macro Functions	<ul style="list-style-type: none"> •User-defined subroutines •The contents of subroutines can be different depending on the users custom designs •Functions can be loaded as a macro on-line •Macro can be run as default function calls •User's know-how can be maintained in privacy
Environmental	
Operating Temperature	-20 ~ +75°C
Storage Temperature	-30 ~ +85°C
Ambient Relative Humidity	5 ~ 90% RH, non-condensing

2

3

PAC Solutions

Features of Motion Function:

2 or 3-Axis Linear Interpolation

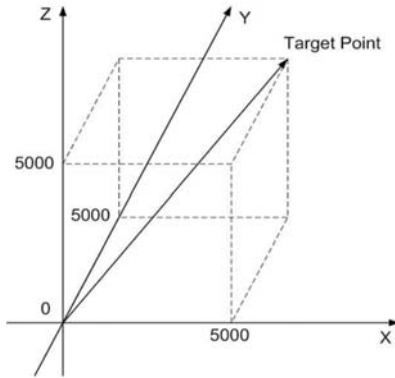

2-Axis Circular Interpolation

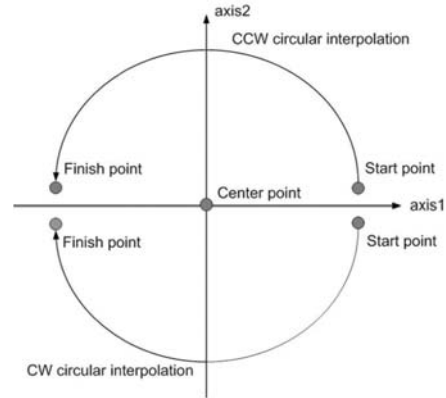

Continuous interpolation

8 Segments Continuous Interpolation Motion (Linear+ Circular)

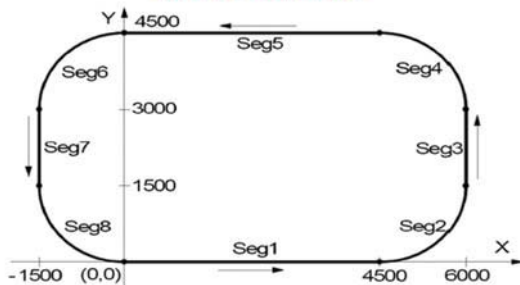

High Speed Position Compare

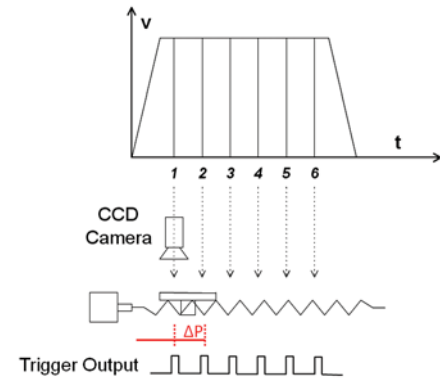

4 Steps Automatic Home Searching

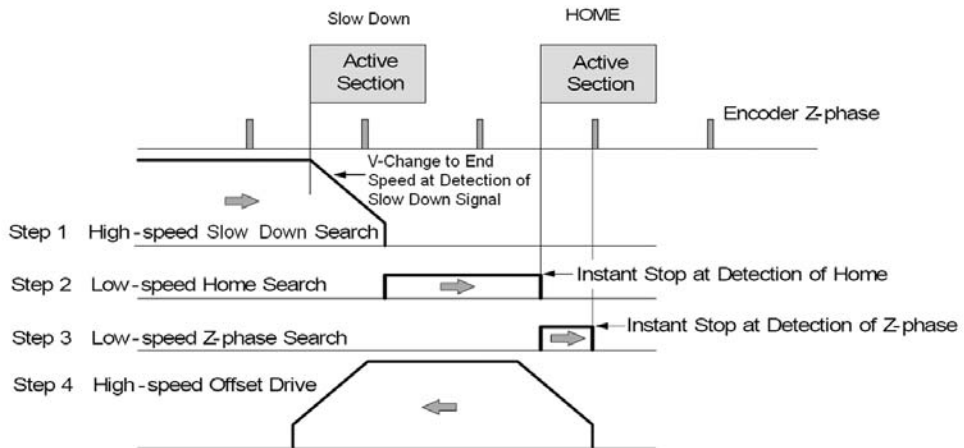

Ordering Information/Accessories:

Module	Description
I-8094A-G	High-speed 4-axis Motion Control Module with Internal CPU
DN-8468UB	Photo-isolated Universal Snap-on Wiring Terminal Board
DN-8468GB	Photo-isolated General Purpose Wiring Terminal Board
DN-8468MB	Photo-isolated Snap-on Wiring Terminal Board for Mitsubishi MELSERVO-J2 Servo Amplifier
DN-8468PB	Photo-isolated Snap-on Wiring Terminal Board for Panasonic MINAS A4/A5 Servo Amplifier
DN-8468YB	Photo-isolated Snap-on Wiring Terminal Board for Yaskawa Sigma II/III/V Servo Amplifier
DN-8468DB	Photo-isolated Snap-on Wiring Terminal Board for Delta ASDA-A Servo Amplifier
DN-8468FB	Photo-isolated Snap-on Wiring Terminal Board for Fuji FALDIC-W Servo Amplifier
CA-SCSI15-H / CA-SCSI30-H / CA-SCSI50-H	68-pin SCSI-II Male-Male Connector Cable, Length 1.5 M / 3.0 M / 5.0 M

I-8094H-G

High-speed 4-axis Motion Control Module with FRnet Master & Internal CPU



Introduction:

The **I-8094H** is a **4-axis** stepping/pulse-type servo motor control module that can be used on any of the ICP DAS PAC series controllers, and is suitable for general-purpose motion applications. The I-8094H has the full functions of the I-8094A with the addition of an FRnet port, which allows the fast remote I/O of the module to be expanded easily. This two-wired FRnet can automatically scan its 128 DI and 128 DO channels within a period of 2.88 ms.

The internal CPU allows the module to be used to perform motion operations without requiring a PAC. When working with a PAC, it also allows users to perform additional functions by integrating user-defined subroutines (Macro functions) from an external source, meaning that customized proprietary processes (know-how) can be embedded in the module. The I-8094H module also contains a high-performance motion ASIC.

In addition to its wide speed range, this intelligent motion controller also has a variety of motion control functions built in, such as 2/3-axis linear interpolation, 2-axis circular interpolation, T/S-curve acceleration/deceleration, numerous synchronous actions, automatic homing, and others. A major advantage is that the majority of the I-8094H motion control functions are performed by the high-performance motion ASIC with little load on the processor. While driving the motors, the motion status, and the status of the other I/O channels on the PAC modules, can still be monitored.

As the CPU loading requirements of the I-8094H is minimal, one or more motion modules may be used with a single PAC controller. ICP DAS also provides a variety of functions and examples that can be used to reduce the need for additional programming by users, making it a highly cost-effective solution for motion control application developers.

Features:

- Independent 4-axis motion control
- Support for hand wheel and jog functions
- 2/3-axis linear / 2-axis circular interpolation function
- Continuous interpolation function
- Programmable T/S-curve acceleration and deceleration
- A maximum pulse output rate of 4 Mpps for each axis
- Pulse Output Types: CW/CCW or PULSE/DIR
- 32-bit encoder counter for each axis
- Encoder Pulse Input Types: A/B Phase or Up/Down
- Programmable automatic homing for each axis
- Position comparison management and software limits
- A wide range of synchronous actions (event-triggered actions)
- Expandable Remote I/O: 128 DI and 128 DO via a two-wire FRnet interface

Specifications:

Number of Axes	4
Maximum Pulse Output Rate	4 MHz
Command Type	Pulse Command
Resolution	32-bit
Pulse Output Mode	CW/CCW, PULSE/DIR
Operation Mode	Semi-closed Loop
Linear Interpolation	Any 2 to 3 of 4 axes
Circular Interpolation	Any 2 axes
Speed Curve Profile	T/S-curve
Motion Relative I/O	Home, LMT+/-, NHOME, EMG, INP, ALM, SVON
Synchronous Action	10 activation factors and 14 actions
Ring Counter Mode	32-bit
Position Control Mode	Incremental mode and absolute mode
Position Compare Trigger	10 KHz
Encoder Interface	A/B pulse, Up/Down
Encoder Counter	32-bit
Encoder Rate	4 MHz
Digital Input Channels	Expandable : 128 DI
Digital Output Channels	Expandable : 128 DO
I/O Isolation(with DN-8468)	2500 Vrms optical isolation
Connector	68-pin SCSI-II connector
Power Consumption	+5 V @ 500 mA
Macro Functions	<ul style="list-style-type: none"> •User-defined subroutines •The contents of subroutines can be different depending on the users custom designs •Functions can be loaded as a macro on-line •Macro can be run as default function calls •User's know-how can be maintained in privacy
Environmental	
Operating Temperature	-20 ~ +75°C
Storage Temperature	-30 ~ +85°C
Ambient Relative Humidity	5 ~ 90% RH, non-condensing

2

3

PAC Solutions

Features of Motion Function:

2 or 3-Axis Linear Interpolation

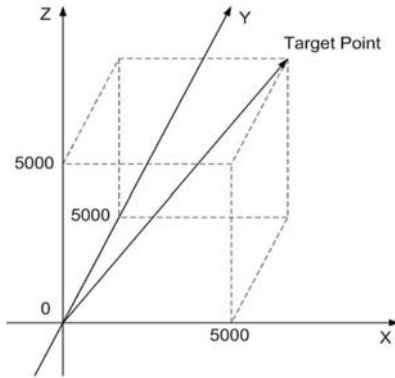

2-Axis Circular Interpolation

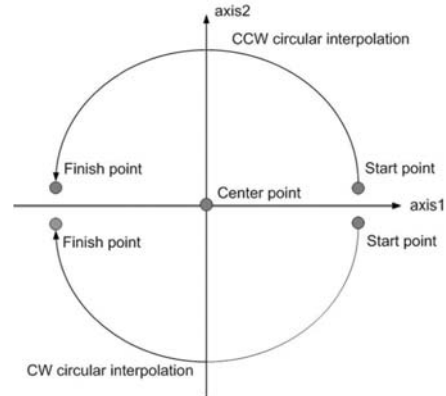

Continuous interpolation

8 Segments Continuous Interpolation Motion (Linear+ Circular)

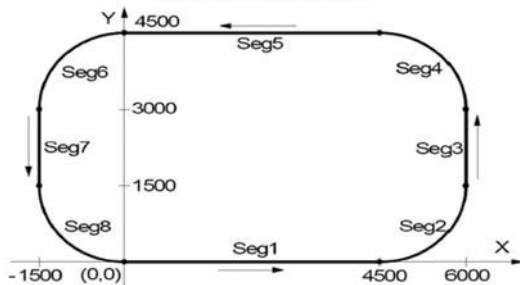

High Speed Position Compare

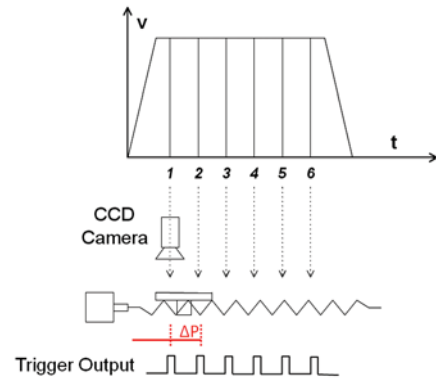

4 Steps Automatic Home Searching

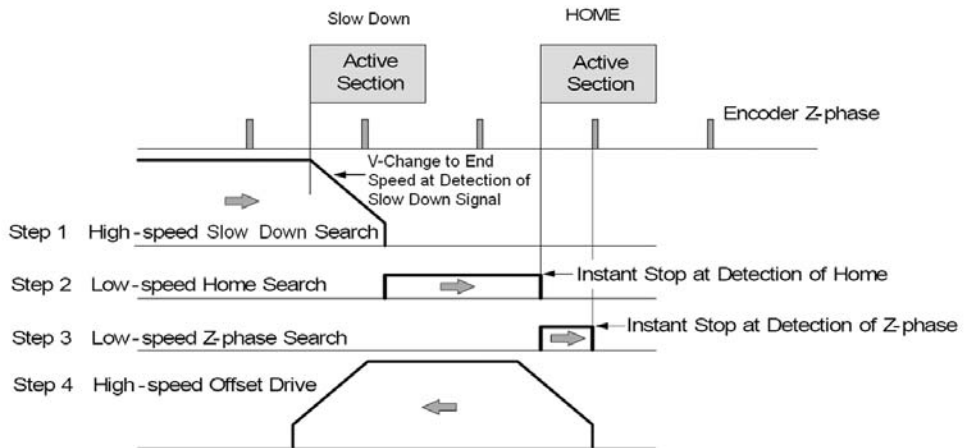

Ordering Information/Accessories:

Module	Description
I-8094H-G	High-speed 4-axis Motion Control Module with FRnet Master and Internal CPU
DN-8468UB	Photo-isolated Universal Snap-on Wiring Terminal Board
DN-8468GB	Photo-isolated General Purpose Wiring Terminal Board
DN-8468MB	Photo-isolated Snap-on Wiring Terminal Board for Mitsubishi MELSERVO-J2 Servo Amplifier
DN-8468PB	Photo-isolated Snap-on Wiring Terminal Board for Panasonic MINAS A4/A5 Servo Amplifier
DN-8468YB	Photo-isolated Snap-on Wiring Terminal Board for Yaskawa Sigma II/III/V Servo Amplifier
DN-8468DB	Photo-isolated Snap-on Wiring Terminal Board for Delta ASDA-A Servo Amplifier
DN-8468FB	Photo-isolated Snap-on Wiring Terminal Board for Fuji FALDIC-W Servo Amplifier
CA-SCSI15-H / CA-SCSI30-H / CA-SCSI50-H	68-pin SCSI-II Male-Male Connector Cable, Length 1.5 M / 3.0 M / 5.0 M

PC-based Solutions



3. PC-based Solutions

PC-based PCI/ISA Bus Motion Cards	3-1
PISO-PS200.....	3-3
PISO-PS400.....	3-5
PISO-PS410.....	3-7
PISO-PS600.....	3-9
PISO-PS810.....	3-11
PISO-ENCODER300U.....	3-13
PISO-ENCODER600U.....	3-14
PISO-PS300U	3-15
PMDK	3-16
ENCODER300	3-17
STEP-200	3-18
SERVO-300	3-19

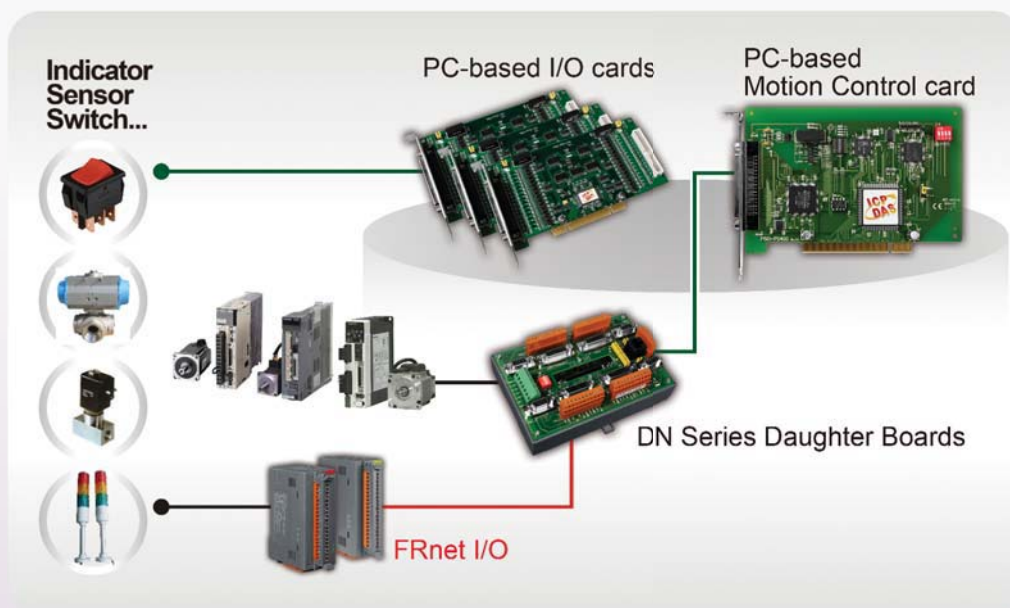

3. PC-based Solutions

PC-based Motion Control Cards

Overview

Introduction

As a leading automation solutions provider, ICP DAS not only provides PAC solutions, but also develops PC-based solutions for machine automation applications, including the PCI bus motion control cards and the ISA bus motion control cards series.

In addition, we also offer a variety of quick-connect terminal blocks for a range of servo motors, including Mitsubishi, Panasonic, Yaskawa, Delta, etc., which helps customers quickly implement the installation and reduce the potential for using the incorrect wiring.

3

PC-based Solutions

Most Cost-Effective
Wide Range Products
Best Service

Servo Motors
 Yaskawa
 Mitsubishi
 Sanyo Denki
 Panasonic

Terminal Boards
 DN-20M
 DN-84100U
 DN-8468UB
 DN-8368GB/
 DN-8368UB

FRnet I/O
 FR-2024 series
 FR-2017 series
 FR-2057 series
 FR-2053 series

PISO-PS810
 8-axis Motion Control Card
 ASIC-based, semi-closed loop

PISO-PS600
 6-axis Motion Control Card
 DSP-based, full-closed loop

PISO-PS400/PISO-PS410
 4-axis Motion Control Card
 ASIC-based, semi-closed loop

Applications

- Semiconductor Manufacturing
- Component Inspection
- Manufacturing Quality Control
- Food and Beverage Inspection
- Microscopy and Medical Imaging
- Biometrics Applications
- X-Y-Z Table
- Fix-pitch Stamping Machinery
- Transfer Machinery
- Spinner
- Load/Unload

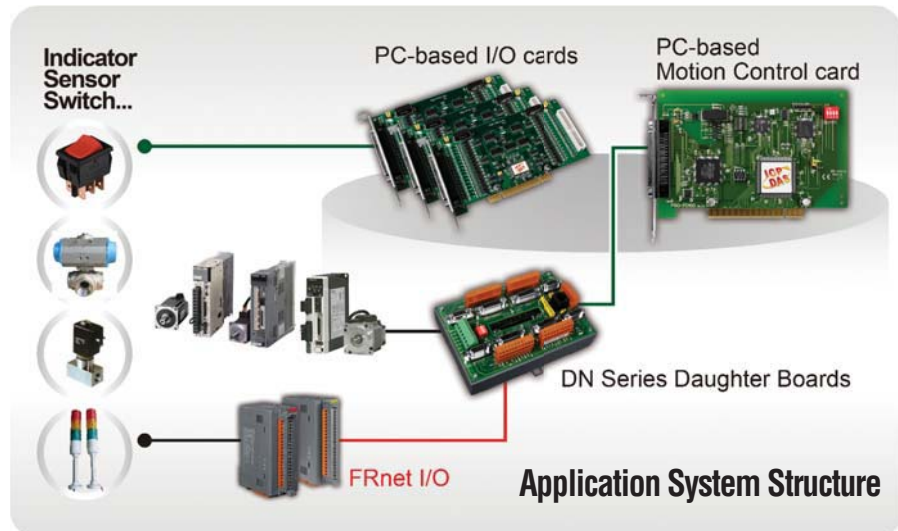

Selection Guide : PC-based PCI/ISA Bus Motion Control Cards and Terminal Boards

PCI Bus Motion Control Cards

PISO-PS200	PCI Bus, High-speed 2-axis Motion Control Card with FRnet Master
PISO-PS300U	PCI Bus, 3-axis Stepper Motor/Servo Control Card (Limited Function and Economical)
PISO-PS400	PCI Bus, High-speed 4-axis Motion Control Card with FRnet Master
PISO-PS410	PCI Bus, High-speed 4-axis Motion Control Card with FRnet Master
PISO-PS600	PCI Bus, High-speed, DSP-based, 6-axis Motion Control Card with FRnet Master
PISO-PS810	PCI Bus, High-speed 8-axis Motion Control Card with FRnet Master (Available Soon!)
PISO-ENCODER300U	PCI Bus, 3-axis Encoder Input Card
PISO-ENCODER600U	PCI Bus, 6-axis Encoder Input Card
PMDK	PCI Bus, DSP-based Professional Motion Development Kit

ISA Bus Motion Control Cards

Encoder300	ISA Bus, 3-axis Encoder Interface Card
STEP-200	ISA Bus, 2-axis High-speed Stepper Motor Control Card (Limited Function and Economical)
SERVO-300	ISA Bus, 3-axis High-speed Servo Motor Control Card (V Command)

Terminal Boards for Machine Automation Products

	DB-8R	Relay Board for Servo-300 and PISO-PS300U
	DB-200	Encoder Input Board for Servo-300
	DN-68 CR	Encoder Input Board for PISO-ENCODER300U/PISO-ENCODER600U
~New~	DN-20M	Manual-Pulse-Generator (MPG) and FRnet Input Board for PISO-PS600/VS600/PMDK
	DN-8237 Series	Photo-isolated Terminal Board for 2-axis Stepper/Servo Motion Controller
	DN-8237UB	Universal Snap-on Wiring Terminal Board
	DN-8237GB	General Purpose Wiring Terminal Board
	DN-8237MB	Snap-on Wiring Terminal Board for Mitsubishi MELSERVO-J2 Servo Amplifier
	DN-8237PB	Snap-on Wiring Terminal Board for Panasonic MINAS A4/A5 Servo Amplifier
	DN-8237YB	Snap-on Wiring Terminal Board for Yaskawa Sigma II/III/V Servo Amplifier
	DN-8237DB	Snap-on Wiring Terminal Board for Delta ASDA-A Servo Amplifier
~New~	DN-8368 Series	Photo-isolated Terminal Board for PISO-PS600/VS600/PMDK
	DN-8368UB	Universal Snap-on Wiring Terminal Board
	DN-8368GB	General Purpose Wiring Terminal Board
	DN-8368MB	Snap-on Wiring Terminal Board for Mitsubishi MELSERVO-J2 Servo Amplifier
	DN-8468 Series	Photo-isolated Terminal Board for ICP DAS 4-axis Stepper/Servo Motion Controllers
	DN-8468UB	Universal Snap-on Wiring Terminal Board
	DN-8468GB	General Purpose Wiring Terminal Board
	DN-8468MB	Snap-on Wiring Terminal Board for Mitsubishi MELSERVO-J2 Servo Amplifier
	DN-8468PB	Snap-on Wiring Terminal Board for Panasonic MINAS A4/A5 Servo Amplifier
	DN-8468YB	Snap-on Wiring Terminal Board for Yaskawa Sigma II/III/V Servo Amplifier
	DN-8468DB	Snap-on Wiring Terminal Board for Delta ASDA-A Servo Amplifier
	DN-8468FB	Snap-on Wiring Terminal Board for Fuji FALDIC-W Servo Amplifier
~New~	DN-84100U	Universal Snap-on Wiring Terminal Board for PISO-PS410 and PISO-PS810

PISO-PS200

PCI Bus, High-speed 2-axis Motion Control Card with FRnet Master



3

PC-based Solutions

Introduction:

The **PISO-PS200** is a **2-axis** stepping/pulse-type servo motor control card that can be used on any IPC with a 5 V PCI bus, and is suitable for general-purpose motion control applications. This card is equipped with one FRnet Master which allows the fast remote I/O of the IPC to be expanded easily. The two-wired FRnet interface allows a maximum 128 DI and 128 DO channels, which are automatically scanned within a period of **2.88 ms**.

In addition to its wide speed range, this intelligent motion controller also has a variety of motion control functions built in, such as **2-axis** linear interpolation, **2-axis** circular interpolation, T/S-curve acceleration/deceleration, numerous synchronous actions, automatic homing, and others. A major advantage is that the majority of the **PISO-PS200** motion control functions are performed by the high-performance motion ASIC with little load on the processor. The motion status, FRnet I/O, and the other I/O cards on the IPC can still be monitored while driving the motors.

As the low CPU loading requirements of the **PISO-PS200** is minimal, one or more motion cards can be used with a single IPC. ICP DAS also provides a variety of functions and examples that can be used to reduce the need for additional programming, making it a highly cost-effective solution for motion control application developers.

Software Support:

Windows Driver/DLL/Lib	Windows XP/2000
DOS Library	-
Labview Development Kit	-
Linux Library	-

Features:

- Independent 2-axis motion control
- Support for hand wheel and jog functions
- 2-axis linear / 2-axis circular interpolation function
- Continuous interpolation function
- Programmable T/S-curve acceleration and deceleration
- A maximum of 4 Mpps pulse output rate for each axis
- Pulse output types: CW/CCW or PULSE/DIR
- 32-bit encoder counter for each axis
- Encoder pulse input types: A/B phase or Up/Down
- Programmable automatic homing for each axis
- Programmable software limits
- Expandable Remote I/O: 128 DI and 128 DO via a two-wire FRnet interface

Specifications:

Number of Axes	2
Slot Interface	5 V PCI bus
Maximum Pulse Output Rate	4 MHz
Command Type	Pulse command
Resolution	32-bit
Pulse Output Mode	CW/CCW, PULSE/DIR
Operation Mode	Semi-closed Loop
Linear Interpolation	2 axes
Circular Interpolation	2 axes
Speed Curve Profile	T/S-curve
Motion Relative I/O	Home, LMT+/-, NHOME, EMG, INP, ALM, SVON
Synchronous Action	-
Ring Counter Mode	32-bit
Position Control Mode	Incremental mode
Position Compare Trigger	-
Encoder Interface	A/B pulse, Up/Down
Encoder Counter	32-bit
Encoder Rate	4 MHz
Digital Input Channels	Expandable: 128 DI
Digital Output Channels	Expandable: 128 DO
I/O Isolation (with DN-8237)	2500 Vrms optical isolation
Connector	37-pin D-sub
Power Consumption	+5 V @ 500 mA
Environmental	
Operating Temperature	-20 ~ +75°C
Storage Temperature	-30 ~ +85°C
Ambient Relative Humidity	5 ~ 90% RH, non-condensing

Features of Motion Function:

2-Axis Linear Interpolation

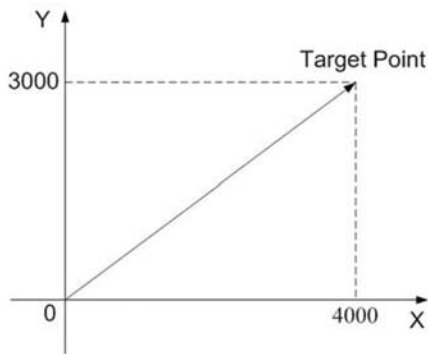

2-Axis Circular Interpolation

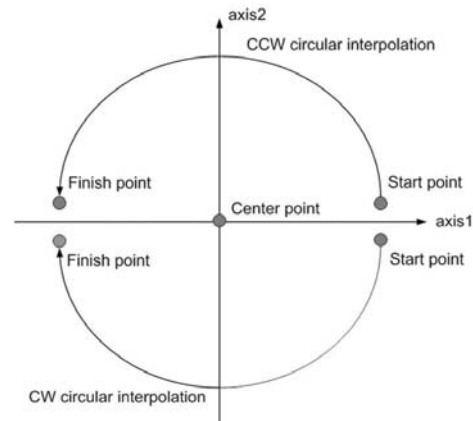

Continuous interpolation

8 Segments Continuous Interpolation Motion (Linear+ Circular)

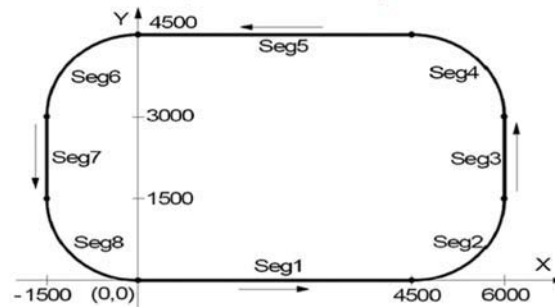

4 Steps Automatic Home Searching

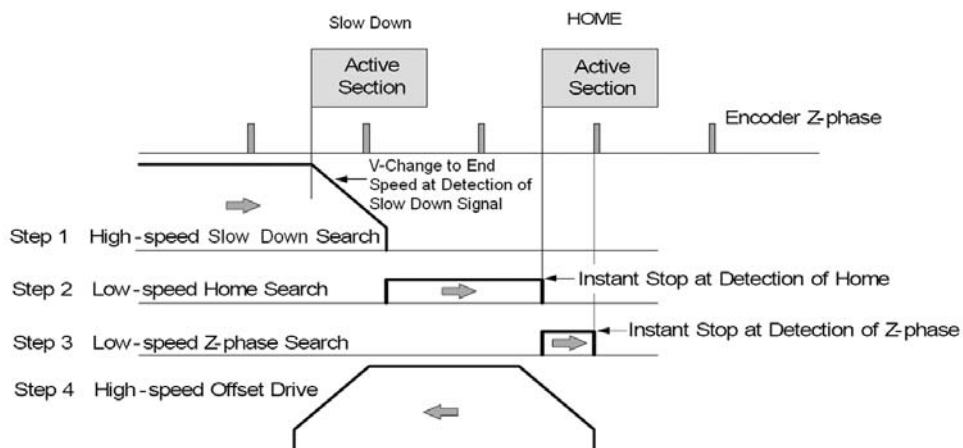

Ordering Information/Accessories:

Model No.	Description
PISO-PS200	PCI Bus, High-speed 2-axis Motion Control Card with FRnet Master
DN-8237UB	Photo-isolated Universal Snap-on Wiring Terminal Board
DN-8237GB	Photo-isolated General Purpose Wiring Terminal Board
DN-8237MB	Photo-isolated Snap-on Wiring Terminal Board for Mitsubishi MELSERVO-J2 Servo Amplifier
DN-8237PB	Photo-isolated Snap-on Wiring Terminal Board for Panasonic MINAS A4/A5 Servo Amplifier
DN-8237YB	Photo-isolated Snap-on Wiring Terminal Board for Yaskawa Sigma II/III/V Servo Amplifier
DN-8237DB	Photo-isolated Snap-on Wiring Terminal Board for Delta ASDA-A Servo Amplifier
CA-3715DM-H / CA-3730DM-H / CA-3750DM-H	37-pin D-Sub Male-Male Cable for Terminal Board (180°), Length 1.5 M / 3.0 M / 5.0 M.

PISO-PS400

PCI Bus, High-speed 4-axis Motion Control Card with FRnet Master



3

PC-based Solutions

Features:

- Independent 4-axis motion control
- Support for hand wheel and jog functions
- 2/3-axis linear / 2-axis circular interpolation function
- Continuous interpolation function
- Programmable T/S-curve acceleration and deceleration
- A maximum pulse output rate of 4 Mpps for each axis
- Pulse output types: CW/CCW or PULSE/DIR
- 32-bit encoder counter for each axis
- Encoder pulse input types: A/B phase or Up/Down
- Programmable automatic homing for each axis
- Programmable software limits
- A wide range of synchronous actions (event-triggered actions)
- Expandable Remote I/O: 128 DI & 128 DO via a two-wire FRnet interface

Introduction:

The **PISO-PS400** is a **4-axis** stepping/pulse-type servo motor control card that can be used on any IPC with a 5 V PCI bus, and is suitable for general-purpose motion control applications. This card equipped with one FRnet Master which allows the fast remote I/O of the IPC to be expanded easily. The two-wired FRnet interface allows a maximum 128 DI and 128 DO channels, which are automatically scanned within a period of **2.88 ms**.

In addition to its wide speed range, this intelligent motion controller also has a variety of motion control functions built in, such as **2/3-axis** linear interpolation, **2-axis** circular interpolation, T/S-curve acceleration/deceleration, numerous synchronous actions, automatic homing, and others. A major advantage is that the majority of the **PISO-PS400** motion control functions are performed by the high-performance motion ASIC with little load on the processor. The motion status, FRnet I/O, and the other I/O cards on the IPC can still be monitored while driving the motors.

As the low CPU loading requirements of the **PISO-PS400** is minimal, one or more motion cards can be used with a single IPC. ICP DAS also provides a variety of functions and examples that can be used to reduce the need for additional programming, making it a highly cost-effective solution for motion control application developers.

Specifications:

Number of Axes	4
Slot Interface	5 V PCI bus
Maximum Pulse Output Rate	4 MHz
Command Type	Pulse Command
Resolution	32-bit
Pulse Output Mode	CW/CCW, PULSE/DIR
Operation Mode	Semi-closed Loop
Linear Interpolation	Any 2 to 3 of 4 axes
Circular Interpolation	Any 2 axes
Speed Curve Profile	T/S-curve
Motion Relative I/O	Home, LMT+/-, NHOME, EMG, INP, ALM, SVON
Synchronous Action	10 activation factors and 14 actions
Ring Counter Mode	32-bit
Position Control Mode	Incremental mode and absolute mode
Position Compare Trigger	10 KHz
Encoder Interface	A/B pulse, Up/Down
Encoder Counter	32-bit
Encoder Rate	4 MHz
Digital Input Channels	Expandable : 128 DI
Digital Output Channels	Expandable : 128 DO
I/O Isolation (With DN-8468)	2500 Vrms optical isolation
Connector	68-pin SCSI-II connector
Power Consumption	+5 V @ 500 mA
Environmental	
Operating Temperature	-20 ~ +75°C
Storage Temperature	-30 ~ +85°C
Ambient Relative Humidity	5 ~ 90% RH, non-condensing

Software Support:

Windows Driver/DLL/Lib	Windows 7 32/64-bit Windows XP/2000 32-bit
DOS Library	-
Labview Development Kit	Labview 5.0 ~ Labview 8.x
Linux Library	-

Features of Motion Function:

2 or 3-Axis Linear Interpolation

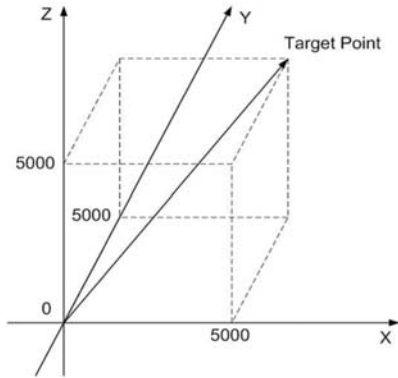

2-Axis Circular Interpolation

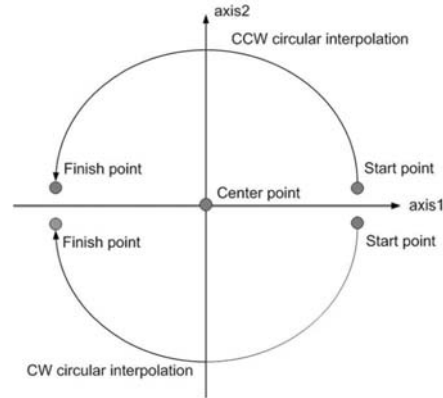

Continuous interpolation

8 Segments Continuous Interpolation Motion (Linear+ Circular)

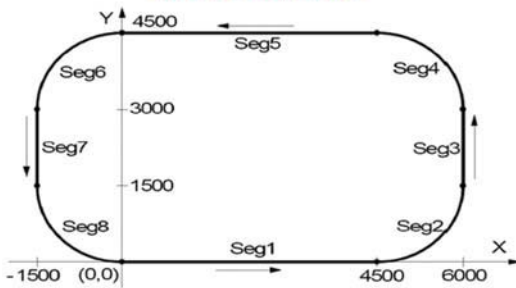

High Speed Position Compare

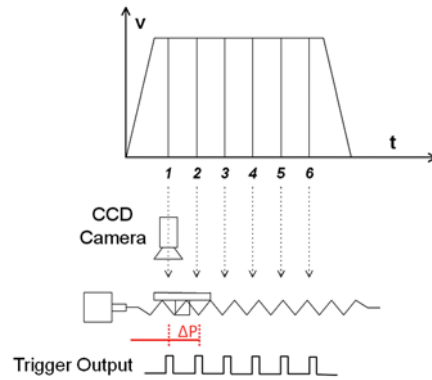

4 Steps Automatic Home Searching

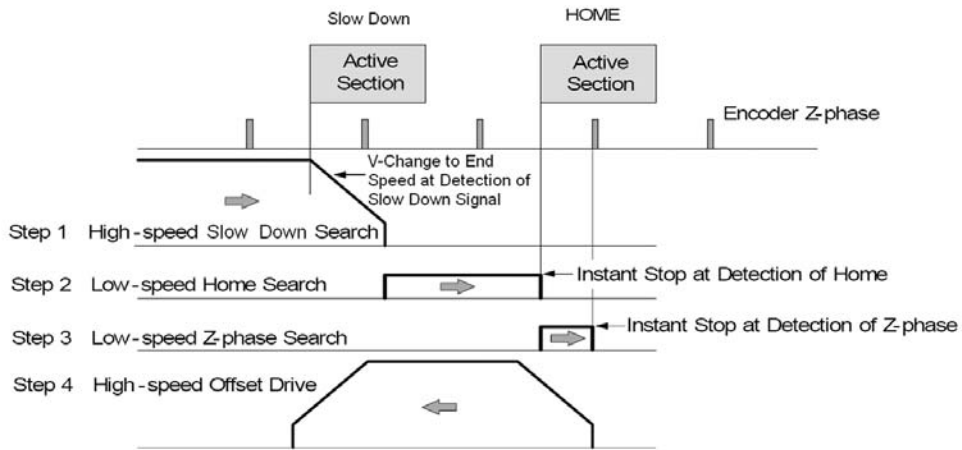

Ordering Information/Accessories:

Model No.	Description
PISO-PS400	PCI Bus, High-speed 4-axis Motion Control Card with FRnet Master
DN-8468UB	Photo-isolated Universal Snap-on Wiring Terminal Board
DN-8468GB	Photo-isolated General Purpose Wiring Terminal Board
DN-8468MB	Photo-isolated Snap-on Wiring Terminal Board for Mitsubishi MELSERVO-J2 Servo Amplifier
DN-8468PB	Photo-isolated Snap-on Wiring Terminal Board for Panasonic MINAS A4/A5 Servo Amplifier
DN-8468YB	Photo-isolated Snap-on Wiring Terminal Board for Yaskawa Sigma II/III/V Servo Amplifier
DN-8468DB	Photo-isolated Snap-on Wiring Terminal Board for Delta ASDA-A Servo Amplifier
DN-8468FB	Photo-isolated Snap-on Wiring Terminal Board for Fuji FALDIC-W Servo Amplifier
CA-SCSI15-H / CA-SCSI30-H / CA-SCSI50-H	68-pin SCSI-II Male-Male Connector Cable, Length 1.5 M / 3 M / 5 M.

PISO-PS410

PCI Bus, High-speed 4-axis Motion Control Card with FRnet Master



Features:

- Independent 4-axis motion control
- Support for hand wheel and jog functions
- 4-step home modes with auto-searching
- 2/3-axis linear interpolation function
- 2-axis circular interpolation function
- Programmable T/S-curve acceleration and deceleration
- Programmable ring counter
- Alarm reset and error counter clear output (ERC)
- High-speed auto incremental and auto reloadable compare output (CMP)
- Expandable remote I/O:
128 DI and 128 DO via a two-wire FRnet interface.

Introduction:

The **PISO-PS410** is a **4-axis** stepping/pulse-type servo motor control card that can be used on any IPC with a 5 V or 3.3 V PCI bus, and is suitable for general-purpose motion control applications. This card equipped with one FRnet Master which allows the fast remote I/O of the IPC to be expanded easily. The two-wired FRnet interface allows a maximum 128 DI and 128 DO channels, which are automatically scanned within a period of **0.72 ms**.

In addition to its wide speed range, this intelligent motion controller also has a variety of motion control functions built in, such as **2/3-axis** linear interpolation, **2-axis** circular interpolation, T/S-curve acceleration/deceleration, numerous synchronous actions, automatic homing, and others. A major advantage is that the majority of the **PISO-PS410** motion control functions are performed by the high-performance motion ASIC with little load on the processor. The motion status, FRnet I/O, and the other I/O cards on the IPC can still be monitored while driving the motors.

As the low CPU loading requirements of the **PISO-PS410** is minimal, one or more motion cards can be used with a single IPC. ICP DAS also provides a variety of functions and examples that can be used to reduce the need for additional programming, making it a highly cost-effective solution for motion control application developers.

Software Support:

Windows Driver/DLL/Lib	Windows 7 32/64-bit Windows XP/2000 32-bit
DOS Library	-
Labview Development Kit	-
Linux Library	-

Specifications:

Number of Axes	4
Slot Interface	Universal PCI Bus
Maximum Pulse Output Rate	4 MHz
Command Type	Pulse Command
Pulse Output Mode	CW/CCW, PULSE/DIR
Operation Mode	Semi-closed Loop
Linear Interpolation	Any 2 to 3 of 4 axes
Circular Interpolation	Any 2 axes
Speed Curve Profile	T/S curve
Mechanical Switch Input	Home, LMT+/-, NHOME, EMG
Servo I/O Interface	Input : INP, ALM Output: SVON, ALM_RST, ERC
Synchronous Action	10 activation factors and 14 actions
Ring Counter Mode	32-bit
Position Control Mode	Incremental mode and absolute mode
Position Compare Trigger	4 MHz
Encoder Interface	A/B pulse, Up/Down
Encoder Counter	32-bit
Encoder Counting Rate	4 MHz
Digital Input Channels	Local : 4 DI Expandable : 128 DI
Digital Output Channels	Local : 4 DO Expandable : 128 DO
I/O Isolation	2500 Vrms optical isolation
Connector	100-pin SCSI-II
Power Consumption	+5 V @ 500 mA
Environmental	
Operating Temperature	-20 ~ +75 °C
Storage Temperature	-30 ~ +85 °C
Ambient Relative Humidity	5 ~ 90 % RH, non-condensing

Features of Motion Function:

2 or 3-Axis Linear Interpolation

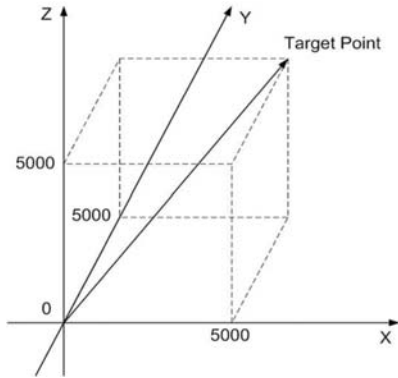

Continuous interpolation

2-Axis Circular Interpolation

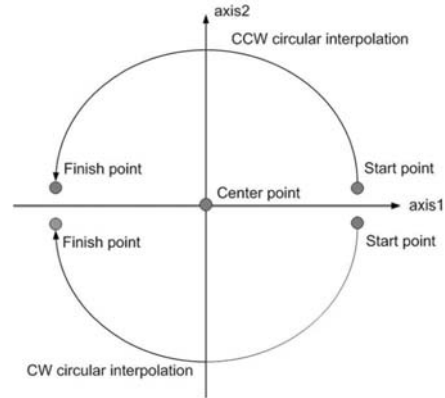

High Speed Position Compare

8 Segments Continuous Interpolation Motion (Linear+ Circular)

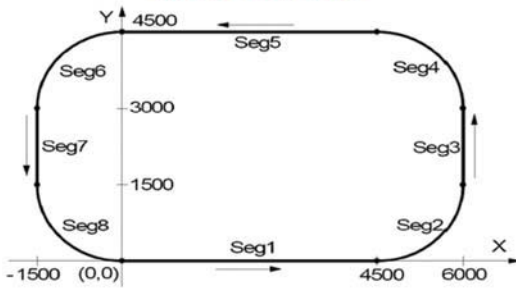

4 Steps Automatic Home Searching

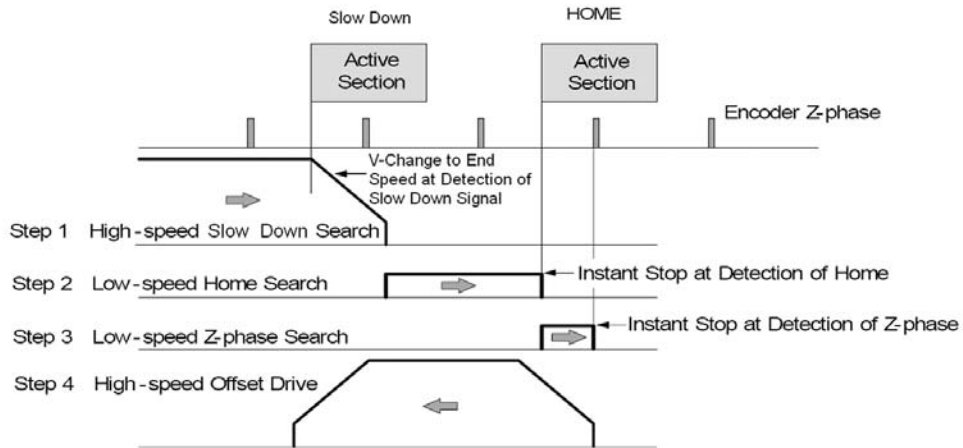

Ordering Information/Accessories:

Model No.	Description
PISO-PS410	PCI Bus, High-speed 4-axis Motion Control Card with FRnet Master
DN-84100U	Universal Snap-on Wiring Terminal Board for PISO-PS410 and PISO-PS810
CA-SCSI100-15	SCSI-II 100-pin & 100-pin Male Connector Cable, Length 1.5 M.

PISO-PS600

PCI Bus, High-speed, DSP-based, 6-axis Motion Control Card with FRnet Master



Features:

- DSP-based motion control card with PCI interface
- Independent 6-axis motion control
- Support both full-closed and semi-closed control modes
- Maximum pulse output frequency: 4 Mpps
- Maximum Encoder input frequency: 12 MHz
- 4-step home mode with auto-searching
- 2- to 6-axis linear/2- to 3-axis circular interpolation function
- Programmable T/S-curve acceleration and deceleration
- Change speed and position on the fly
- High-speed position latch and compare trigger
- Fully-functional manual-pulse-generator and jog functions
- Expandable remote I/O: 128 DI and 128 DO via a two-wire FRnet interface.



3

PC-based Solutions

Introduction:

The **PISO-PS600** controller combines a new generation 1600 MIPS digital signal processor with a 9526 logic element FPGA (Field Programmable Gate Array), I/O buffering circuitry, and motion control characterization software to control the position of **6-axis** pulse command servo/stepper motors. The **PISO-PS600** not only realizes motion control using full-closed loop (or semi-closed loop) operations and error handling, but also adopts feed-forward gain to reduce the speed profile following errors to achieve position control.

The **PISO-PS600** can be used on any IPC with a PCI bus, and is suitable for general-purpose motion control applications. This card also contains one FRnet port which allows the fast digital I/O of the IPC to be easily expanded. This two-wired FRnet interface allows a maximum 128 DI and 128 DO channels, which are automatically scanned within a period of **0.72 ms**. In additions to its wide speed range, this intelligent motion controller also has a variety of built-in motion control functions, such as **2- to 6-axis** linear interpolation, **2- to 3-axis** circular interpolation, T/S-curve acceleration/deceleration, and automatic homing, etc.

Software Support:

Windows Driver/DLL/Lib	Windows 7 32/64-bit Windows XP/2000 32-bit
DOS Library	-
Labview Development Kit	-
Linux Library	-

Specifications:

Number of Axes	6
Slot Interface	Universal PCI Bus
Maximum Pulse Output Rate	4 MHz
Command Type	Pulse Command
Servo Update Rate	2 KHz
Pulse Output Mode	CW/CCW, PULSE/DIR, A/B pulse
Operation Mode	Full-closed Loop/Semi-closed Loop
Linear Interpolation	Any 2 to 6 of 6 axes
Circular Interpolation	Any 2 to 3 of 6 axes
Speed Curve Profile	T/S-curve
Mechanical Switch Input	Home, LMT+/-, NHOME, LTC, EMG
Servo I/O Interface	Input: INP, ALM, RDY Output: SVON, ALM_RST, ERC
Ring Counter Mode	32-bit
Position Control Mode	Incremental mode and absolute mode
Position Compare Trigger	4 MHz
Encoder Interface	A/B pulse, Up/Down
Encoder Counter	32-bit
Encoder Counting Rate	12 MHz
Digital Input Channels	Local: 12 DI Expandable: 128 DI
Digital Output Channels	Local: 3 DO Expandable: 128 DO
I/O Isolation (with DN-8368)	2500 Vrms optical isolation
Connector	68-pin VHDCI Connector and 20-pin SCSI-II
Power Consumption	+5 V @ 500 mA
Environmental	
Operating Temperature	0 ~ +60 °C
Storage Temperature	-20 ~ +80 °C
Ambient Relative Humidity	5 ~ 90 % RH, non-condensing

Features of Motion Function:

2 to 6-Axis Linear Interpolation

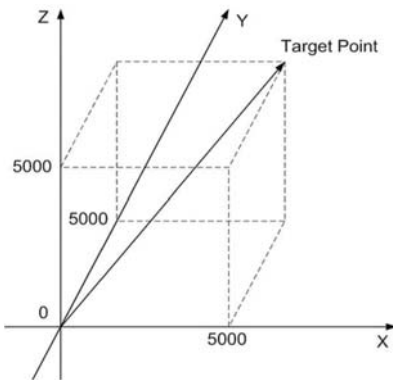

3-Axis Circular or Helical Interpolation

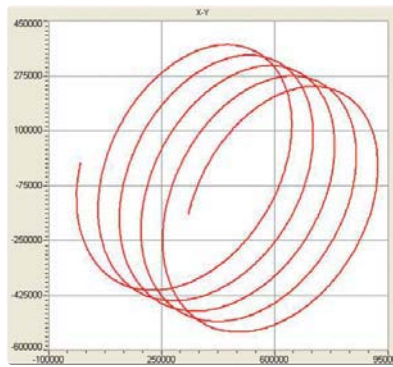

High Speed Position Compare

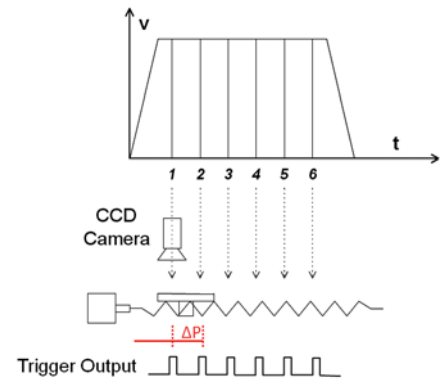

Multi-Axis Continuous Interpolation
(With Acc. and Dec.)

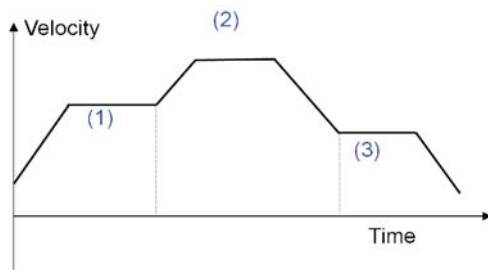

Huge Command Buffer and Real Time Coordinate Transformation
Suitable for Robotic Control



4 Steps Automatic Home Searching

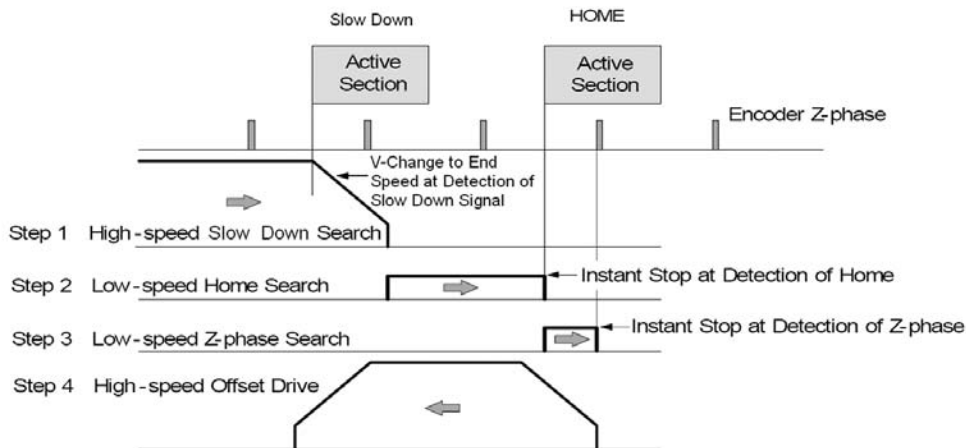

Ordering Information/Accessories:

Model No.	Description
PISO-PS600	PCI Bus, High-Speed, DSP-based, 6-axis Motion Control Card with FRnet Master
DN-8368UB	Photo-isolated Universal Snap-on wiring terminal board
DN-8368GB	Photo-isolated General-purpose wiring terminal board
DN-8368MB	Photo-isolated Snap-on wiring terminal board for Mitsubishi MELSERVO-J2 servo amplifier
DN-20M	Manual-Pulse-Generator (MPG) and FRnet Input Board for PISO-PS600/VS600/PMDK (RoHS)
CA-MINI68-15	68-pin VHDCI to SCSI-II Connector Cable, Length 1.5 M
CA-SCSI20-M1 / CA-SCSI20-M3 / CA-SCSI20-M5	20-pin SCSI-II Male connector cable (for Mitsubishi J2 series motor), Length 1 M / 3 M / 5 M.

PISO-PS810

PCI Bus, High-speed 8-axis Motion Control Card with FRnet Master

Available soon



Features:

- Independent 8-axis motion control
- Support for hand wheel and jog functions
- 4-step home modes with auto-searching
- 2/3-axis linear interpolation function
- 2-axis circular interpolation function
- Programmable T/S-curve acceleration and deceleration
- Programmable ring counter
- Alarm reset and error counter clear output (ERC)
- High-speed auto-incremental and auto-reloadable compare output (CMP)
- Expandable remote I/O: 128 DI & 128 DO via a two-wire FRnet interface



3

PC-based Solutions

Introduction:

The **PISO-PS810** is a 8-axis stepping/pulse-type servo motor control card that can be used on any IPC with a 5 V or 3.3 V PCI bus, and is suitable for general-purpose motion applications. This card equipped with one FRnet Master which allows the fast remote I/O of the IPC to be expanded easily. The two-wired FRnet interface allows a maximum 128 DI and 128 DO channels, which are automatically scanned within a period of **0.72 ms**.

In addition to its wide speed range, this intelligent motion controller also has a variety of motion control functions built in, such as **2/3-axis** linear interpolation, **2-axis** circular interpolation, T/S-curve acceleration/deceleration, numerous synchronous actions, automatic homing, and others. A major advantage is that the majority of the **PISO-PS810** motion control functions are performed by the high-performance motion ASIC with little load on the processor. The motion status, FRnet I/O, and the other I/O cards on the IPC can still be monitored while driving the motors.

As the low CPU loading requirements of the **PISO-PS810** is minimal, one or more motion cards can be used with a single IPC. ICP DAS also provides a variety of functions and examples that can be used to reduce the need for additional programming, making it a highly cost-effective solution for motion control application developers.

Software Support:

Windows Driver/DLL/Lib	Windows 7 32/64-bit Windows XP/2000 32-bit
DOS Library	-
Labview Development Kit	-
Linux Library	-

Specifications:

Number of Axes	8
Slot Interface	Universal PCI bus
Maximum Pulse Output Rate	4 MHz
Command Type	Pulse Command
Resolution	32-bit
Pulse Output Mode	CW/CCW, PULSE/DIR
Operation Mode	Semi-closed Loop
Linear Interpolation	2 groups of 2 to 3 axes Interpolation
Circular Interpolation	2 groups of 2 axes Interpolation
Speed Curve Profile	T/S curve
Motion Relative I/O	Home, LMT+/-, NHOME, EMG, INP, ALM, SVON, ALM_RST, ERC
Synchronous Action	10 activation factors and 14 actions
Ring Counter Mode	32-bit
Position Control Mode	Incremental mode and absolute mode
Position Compare Trigger	4 MHz
Encoder Interface	A/B Pulse, Up/Down
Encoder Counter	32-bit
Encoder Rate	4 MHz
Digital Input Channels	Local : 8 DI Expandable : 128 DI
Digital Output Channels	Local : 8 DO Expandable : 128 DO
I/O Isolation	2500 Vrms optical isolation
Connector	100-pin VHDCI
Power Consumption	+5 V @ 500 mA
Environmental	
Operating Temperature	-20 ~ +75 °C
Storage Temperature	-30 ~ +85 °C
Ambient Relative Humidity	5 ~ 90 % RH, non-condensing

Features of Motion Function:

2 or 3-Axis Linear Interpolation

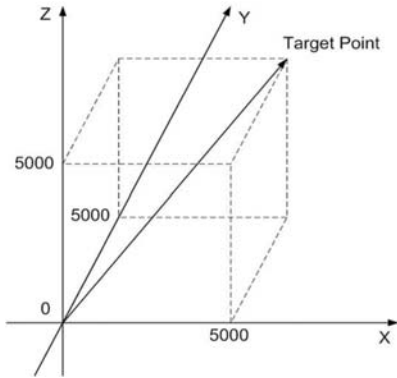

2-Axis Circular Interpolation

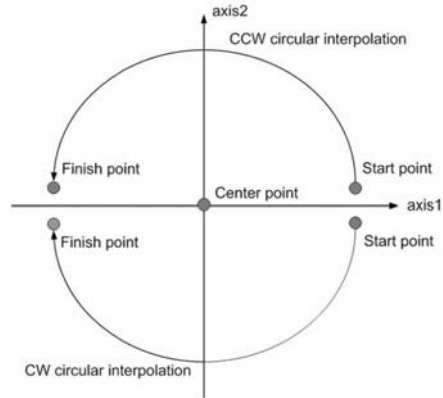

Continuous interpolation

8 Segments Continuous Interpolation Motion (Linear+ Circular)

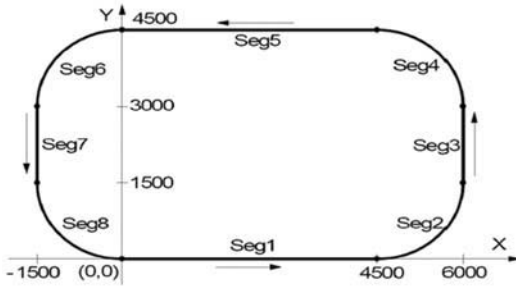

High Speed Position Compare

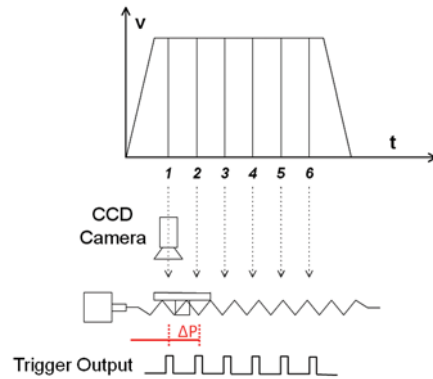

4 Steps Automatic Home Searching

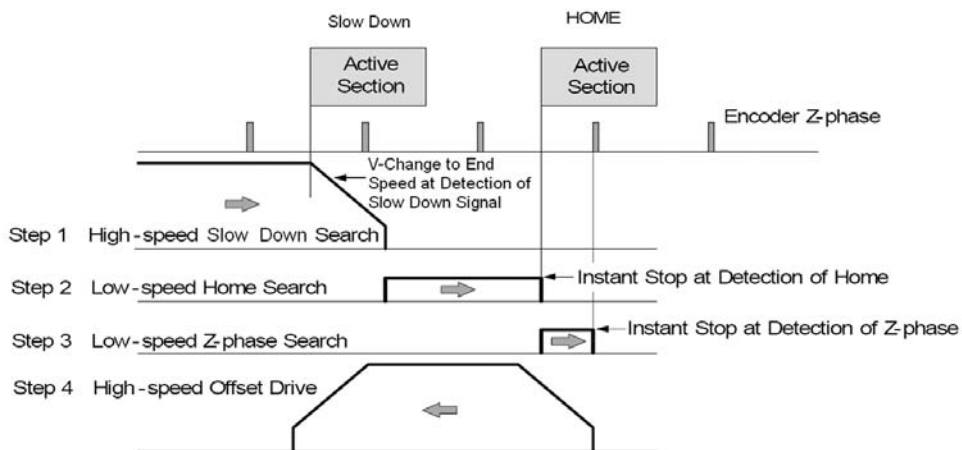

Ordering Information/Accessories:

Model No.	Description
PISO-PS810	PCI Bus, High-speed 8-axis Motion Control Card with FRnet Master
DN-84100U	Universal Snap-on Wiring Terminal Board for PISO-PS410 and PISO-PS810
CA-MINI100-15	100-pin VHDCI to SCSI-II Connector Cable, Length 1.5 M

PISO-ENCODER300U

PCI Bus, 3-axis Encoder Input Card



Features:

- Universal PCI bus
- 3-axis encoder counter
- True 32-bit counter
- Maximum Counting Rate: 1 MHz
- Third-order internal digital filter
- Counting Mode: Quadrant, CW/CCW, PULSE/DIR
- A+, A-, B+, B-, C+, C- inputs
- Programmable reset counter function
- Index (C channel) reset counter function
- Hardware reset (HR1 ~ HR6), reset counter function
- 68-pin SCSI-II connector

Introduction:

The **PISO-ENCODER300U** contains a **3-axis** encoder counter and each axis has a 32-bit, true counter with a maximum counting rate of 1 MHz. The counting mode can be selected from three types: 1. Quadrant mode, 2. CW/CCW mode, and 3. PULSE/DIR mode. There are also three kinds of counter reset modes provided: 1. Register Reset, 2. Index Reset, and 3. Hardware Reset. The "Index Reset" mode resets by using a C+/C- channel, which will reset the counter on each revolution. The "Hardware Reset" mode resets the counter using an external pin (HR1 ~ HR6). The HR1 ~ HR6 pins can also be used as digital input.

The **PISO-ENCODER300U** also provides 8-ch digital outputs. 2500 Vrms photo-couplers are used to isolate the digital I/O to prevent high voltages from affecting the system. Device drivers and function libraries for DOS, Windows 7 and Windows XP/2000 are provided.

Specifications:

Number of Axes	3
Slot Interface	Universal PCI bus
Resolution	32-bit
Encoder Mode	Quadrant, CW/CCW, PULSE/DIR
Maximum Counting Rate	1 MHz
Digital Output Channels	8
I/O Isolation	2500 Vrms optical isolation
Connector	68-pin SCSI-II female connector
Power Consumption	+5 V @ 500 mA
Environmental	
Operating Temperature	0 ~ +60°C
Storage Temperature	-20 ~ +80°C
Ambient Relative Humidity	0 ~ 90% RH, non-condensing
Dimensions	120.4 mm x 90.8 mm

Software Support:

Windows Driver/DLL/Lib	Windows 7 32/64-bit Windows XP/2000 32-bit
DOS Library	DOS 6.2
Labview Development Kit	Labview 8.5 and above
Linux Library	-

Ordering Information/Accessories:

Model No.	Description
PISO-ENCODER300U CR	Universal PCI Bus 3-axis Encoder Input Card (RoHS) Includes: CA-SC68, SCSI-II 68-pin Male Connector (Solder Type) with Cover
DN-68 CR	Encoder Input Board for PISO-ENCODER300U / PISO-ENCODER600U

PISO-ENCODER600U

PCI Bus, 6-axis Encoder Input Card



Features:

- Universal PCI bus
- 6-axis encoder counter
- True 32-bit counter
- Maximum Counting Rate: 1 MHz
- Third-order internal digital filter
- Counting Mode: Quadrant, CW/CCW, PULSE/DIR
- A+, A-, B+, B-, C+, C- inputs
- Programmable reset counter function
- Index (C channel) reset counter function
- Hardware reset (HR1 ~ HR6), reset counter function
- 68-pin SCSI-II connector

Introduction:

The **PISO-ENCODER600U** contains a **6-axis** encoder counter and each axis has a 32-bit, true counter with a maximum counting rate of 1 MHz. The counting mode can be selected from three types: 1. Quadrant mode, 2. CW/CCW mode, and 3. PULSE/DIR mode. There are also three 3 kinds of counter reset modes provided: 1. Register Reset, 2. Index Reset, and 3. Hardware Reset. The "Index Reset" mode resets by using a C+/C- channel, which will reset the counter on each revolution. The "Hardware Reset" mode resets the counter using an external pin (HR1 ~ HR6). The HR1 ~ HR6 pins can also be used as digital input.

The **PISO-ENCODER600U** also provides 8-ch digital outputs. 2500 Vrms photo-couplers are used to isolate the digital I/O to prevent high voltages from affecting the system. Device drivers and function libraries for DOS, Windows 7 and Windows XP/2000 are provided.

Specifications:

Number of Axes	6
Slot Interface	Universal PCI bus
Resolution	32-bit
Encoder Mode	Quadrant, CW/CCW, PULSE/DIR
Maximum Counting Rate	1 MHz
Digital Output Channels	8
I/O Isolation	2500 Vrms optical isolation
Connector	68-pin SCSI-II female connector
Power Consumption	+5 V @ 500 mA
Environmental	
Operating Temperature	0 ~ +60°C
Storage Temperature	-20 ~ +80°C
Ambient Relative Humidity	0 ~ 90% RH, non-condensing
Dimensions	120.4 mm x 90.8 mm

Software Support:

Windows Driver/DLL/Lib	Windows 7 32/64-bit Windows XP/2000 32-bit
DOS Library	DOS 6.2
Labview Development Kit	Labview 8.5 and above
Linux Library	Linux 2.6

Ordering Information/Accessories:

Model No.	Description
PISO-ENCODER600U CR	Universal PCI Bus 6-axis Encoder Input Card (RoHS) Includes: CA-SC68, SCSI-II 68-pin Male Connector (Solder Type) with Cover
DN-68 CR	Encoder Input Board for PISO-ENCODER300U / PISO-ENCODER600U

PISO-PS300U

PCI Bus, 3-axis Stepper Motor/Servo Control Card (Limited Functions and Economical)



Features:

- Universal PCI Bus
- 3-axis pulse command servo motor board
- Embedded CPU
- Max. Pulse Rate: 1 MHz
- 3-axis linear interpolation, circular interpolation
- Programmable trapezoidal speed profile
- Programmable DDA cycle
- Hardware emergency stop
- Drivers for DOS, Windows XP/2000 and Windows 7
- 8 DI, 7 DO channels

Specifications:

Number of Axes	3
Slot Interface	Universal PCI bus
Resolution	32-bit
Command Type	Pulse command
Maximum Pulse Output Rate	1 MHz
Pulse Output Mode	CW/CCW, PULSE/DIR
Operation Mode	Semi-closed Loop
Linear Interpolation	Any 2 to 3 of 3 axes
Circular Interpolation	Any 2 axes
Speed Curve Profile	T-curve
Motion Relative I/O	Home, forward, backward limit, EMG, SVON
Synchronous Action	-
Ring Counter Mode	-
Position Control Mode	Incremental mode
Position Compare Trigger	-
Encoder Interface	A/B phase, CW/CCW, PULSE/DIR
Encoder Counter	32-bit
Encoder Rate	1 Mz
Digital Input Channels	8
Digital Output Channels	7
I/O Isolation	2500 Vrms optical isolation
Connector	9-pin male and 25-pin female D-sub
Power Consumption	+5 V @ 950 mA
Environmental	
Operating Temperature	0 ~ +60°C
Storage Temperature	-20 ~ +70°C
Ambient Relative Humidity	0~90% RH, non-condensing

Introduction:

The **PISO-PS300U** is a **3-axis** pulse command, servo motor control board. The embedded CPU of the PISO-PS300U performs the motion commands transferred from a Host PC via a 2 KB FIFO buffer. It also sends the position and status to the Host PC via a second 2 KB FIFO buffer. These buffers provide time buffer and they are very suitable for Windows operating systems. Device drivers and function libraries for DOS, Windows 7 and Windows XP/2000 are provided.

Software Support:

Windows Driver/DLL/Lib	Windows 7 32/64-bit Windows XP/2000 32-bit
DOS Library	-
Labview Development Kit	-
Linux Library	-

Ordering Information/Accessories:

Model No.	Description
PISO-PS300U CR	Universal PCI Bus, 3-axis Stepper Motor/Servo Control Card (Limited Functions and Economical) Includes: CA-9-2502 (9-pin Male and 25-pin Female D-Sub Cable, Length 0.2 M) CA-PC09F (9-pin Female D-Sub Connector with Plastic Cover) CA-PC09M (9-pin Male D-Sub Connector with Plastic Cover) CA-PC25M (25-pin Male D-Sub Connector with Plastic Cover)
DB-8R	Relay Board for SERVO-300 and PISO-PS300U

PMDK

PCI Bus, DSP-based Professional Motion Development Kit



Features:

- DSP-based control card with PCI interface
- Capable of 6-axis motion control
- Maximum Pulse Output Frequency: 4 Mpps
- Maximum Encoder Input Frequency: 12 Mpps
- High-speed position latching and comparing functions
- Home, positive and negative limit sensors for each axis
- Manual-pulse-generator (MPG) interface
- Expandable Remote I/O: 128 DI & 128 DO via a two-wire FRnet interface

Introduction:

The **PMDK** is a DSP-based PCI motion control card suitable for the development of professional motion control applications, and can be used with any IPC that has a 5 V PCI bus. A wide range of applications can be implemented thanks to the integration of a high-speed DSP (TI C672x), an FPGA (Field Programmable Gate Array), and I/O buffering circuitry. A diverse array of I/O interfaces are incorporated into the PMDK, including 6 channels for pulse I/O, 6 channels for AI/AO and a variety of DI/DO channels. The card also includes a single two-wire FRnet port that can be used to remotely control up to 128 DI and 128 DO channels, which, together with the numerous software samples that are provided, allows the rapid development of custom programs.

The PMDK enables users to implement a variety of cost-effective motion control functions, including multi-axis linear and circular interpolation with acceleration/deceleration processing. A variety of synchronous actions are also possible through programming. The included sample software can be used to design custom motion functions which can then be appended to the original motion command set. DSP programs are developed based on a real-time kernel (DSP/BIOS), meaning that motion status, FRnet I/O status and the status of other I/O interfaces can still be monitored while driving operations are being performed, and, as the loading on the CPU is very low, one or more motion cards can be used on a single IPC.

If the PMDK is to be used for signal processing, users can refer to a range of samples provided by ICP DAS illustrating how to implement FFT, FIR and IIR, together with the resources provided by TI. In the future, ICP DAS will be providing a wider library of functions and examples that will further reduce the level of programming required by users in order to implement their custom applications. In summary, the PMDK is a highly cost-effective solution for users intending to develop custom applications for motion control, process control, I/O logic control, digital processing, and applications in a wide range of other domains.

Ordering Information/Accessories:

Model No.	Description
PMDK	PCI Bus DSP-based Professional Motion Development Kit
DN-8368UB	Photo-isolated Universal Snap-on wiring terminal board
DN-8368GB	Photo-isolated General-purpose wiring terminal board
DN-8368MB	Photo-isolated Snap-on wiring terminal board for Mitsubishi MELSERVO-J2 servo amplifier
DN-20M	Manual-Pulse-Generator (MPG) and FRnet Input Board for PISO-PS600/VS600/PMDK (RoHS)
CA-MINI68-15	68-pin VHDCI to SCSI-II Connector Cable, Length 1.5 M
CA-SCSI20-M1 / M3 / M5	SCSI-II 20-pin and 20-pin Male Connector Cable for Mitsubishi Motor, Length 1 M / 3 M / 5 M.
CA-2P4C-0100	The Cable for FRnet Modules, Length 100 M.

Specifications:

Number of Axes	6
Slot Interface	Universal PCI bus
Maximum Pulse Output Rate	4 MHz
Command Type	Pulse command, V command
Resolution	32-bit
Servo Update Rate	User Programmable
Pulse Output Mode	CW/CCW, PULSE/DIR
Motion Relative I/O	Home, LMT+/-, NHOME, EMG, INP, ALM, SVON, ALM_RST, ERC
Position Compare Trigger	User Programmable
Encoder Interface	A/B pulse, Up/Down
Encoder Counter	32-bit
Encoder Counting Rate	12 MHz
Digital Input Channels	Expandable: 128 DI
Digital Output Channels	Expandable: 128 DO
I/O Isolation (with DN-8368)	2500 Vrms optical isolation
Connector	68-pin SCSI-II connector & 20-pin SCSI-II
Power Consumption	-
Environmental	
Operating Temperature	-20 ~ +75°C
Storage Temperature	-30 ~ +85°C
Ambient Relative Humidity	5 ~ 90% RH, non-condensing

ENCODER300

ISA Bus, 3-axis Encoder Interface Card



Features:

- Accepts inputs from incremental or quadrature encoders
- 3 independent axes
- Max. Quadrature Input Frequency: 1 MHz
- Counts per Encoder Cycle: X1, X2, X4 (Software selectable)
- Encoder Input Modes: Quadrature , Up/Down , PULSE/DIR



3

PC-based Solutions

Introduction:

The **ENCODER300** is a **3-axis** quadrature encoder interface board for IBM PC/AT bus-compatible devices. Phase 0, phase 90 and index pulse inputs are provided for each encoder. Inputs may be single ended (A, B or C) or differential (A+, A-, B+, B-, C+ or C-). Power and ground connections are also provided for use by the encoder if needed. Inputs are conditioned by a four-stage digital filter, and the maximum input rate in quadrature decode mode is 1 MHz. The conditioned inputs are applied to a 16-bit counter, which may be used for quadrature decoding, pulses or direction-input counting, or as a pulse input up/down counter.

Specifications:

Number of Axes	3
Slot Interface	ISA bus
Resolution	16-bit
Mode	Quadrant, CW/CCW, PULSE/DIR
Maximum Counting Rate	1 MHz
Digital Output Channels	-
I/O Isolation	-
Connector	25-pin D-Sub
Power Consumption	+5 V @ 500 mA
Environmental	
Operating Temperature	0 ~ +60°C
Storage Temperature	-20 ~ +80°C
Ambient Relative Humidity	0 ~ 90 % RH, non-condensing

Software Support:

Windows Driver/DLL/Lib	Windows 95/98/ME/NT4.0
DOS Library	DOS 6.2
Labview Development Kit	-
Linux Library	-

Ordering Information/Accessories:

Model No.	Description
ENCODER300	ISA Bus, 3-axis Encoder Interface Card Includes: CA-PC25M (25-pin Male D-Sub Connector with Plastic Cover)
DN-25	I/O Connector Block with 25-pin/9-pin D-Sub Connector (DIN-Rail Mounting)

STEP-200

ISA Bus, 2-axis High-speed Stepper Motor Control Card (Limited Functions and Economical)



Introduction:

The **STEP-200** is a **2-axis**, command-based stepper motor controller board for IBM PC/XT/AT bus-compatible devices. The board can also be used for pulse-type servo motor control (pulse input type). The board includes a build-in μ P that performs a variety of motion control commands and shares the loading of the host computer. A 2 KB FIFO is included as a command buffer, which provides a buffer time of 1360 ms. The hardware architecture of **STEP-200** is ideal for the Windows operating system, and drivers for DOS and Windows are provided offering real-time motion control solutions for Windows systems.

Software Support:

Windows Driver/DLL/Lib	Windows 95/98/ME/NT4.0
DOS Library	DOS 6.2
Labview Development Kit	-
Linux Library	-

Features:

- 2-axis independent, simultaneous stepper motor control/servo motor control (Pulse input type)
- Drivers for DOS, Windows 95/98/ME, Windows NT
- Embedded Microprocessor
- Command Type Interface
- Linear and circular interpolation
- Acceleration/deceleration:
Automatic trapezoidal acceleration/deceleration
- Output polarity can be programmable
- 5 optical isolated digital inputs per axis for limit switches

Specifications:

Number of Axes	2
Slot Interface	ISA bus
Maximum Pulse Output Rate	250 Kpps
Command Type	Pulse command
Resolution	32-bit
Servo Update Rate	-
Pulse Output Mode	CW/CCW, PULSE/DIR
Operation Mode	Open loop
Linear Interpolation	-
Circular Interpolation	-
Speed Curve Profile	T-curve
Motion Relative I/O	Home, forward, backward limit, EMG
Synchronous Action	-
Ring Counter Mode	32-bit
Position Control Mode	Incremental mode and absolute mode
Position Compare Trigger	10 KHz
Encoder Interface	A/B pulse, Up/Down
Encoder Counter	-
Encoder Rate	-
Digital Input Channels	-
Digital Output Channels	-
I/O Isolation	2500 Vrms optical isolation
Connector	25-pin D-Sub
Power Consumption	+5 V @ 500 mA
Environmental	
Operating Temperature	0 ~ +50°C
Storage Temperature	-20 ~ +70°C
Ambient Relative Humidity	0 ~ 90% RH, non-condensing

Ordering Information/Accessories:

Model No.	Description
STEP-200	ISA Bus, 2-axis High-speed Stepper Motor Control Card (Limited Functions and Economical) Includes: CA-PC25M (25-pin Male D-Sub Connector with Plastic Cover)
DN-25	I/O Connector Block with 25-pin/9-pin D-Sub Connector (DIN-Rail Mounting)

SERVO-300

ISA Bus, 3-axis High-speed Servo Motor Control Card (V Command)



Features:

- ISA bus servo motor control card
- 3-axis high-speed servo motor control card
- V command
- Drivers for DOS and Windows

Specifications:

Number of Axes	3
Slot Interface	ISA bus
Maximum Pulse Output Rate	-
Command Type	Voltage command
Resolution	12-bit +/-10 V
Servo Update Rate	3 ms / 3 axes
Pulse Output Mode	-
Operation Mode	Simulation, closed loop, open loop
Linear Interpolation	Any 2 to 3 of 3 axes
Circular Interpolation	Any 2 axes
Speed Curve Profile	T-curve
Motion Relative I/O	Home, forward, backward limit, EMG
Encoder Interface	CW/CCW, PULSE/DIR
Encoder Counter	32-bit
Encoder Rate	1 Mz
Digital Input Channels	8
Digital Output Channels	7
I/O Isolation	2500 Vrms optical isolation
Connector	9-pin male & 25-pin female D-Sub
Power Consumption	+5 V @ 500 mA
Environmental	
Operating Temperature	0 ~ +60°C
Storage Temperature	-20 ~ +80°C
Ambient Relative Humidity	0 ~ 90% RH, non-condensing
Dimensions	120.4 mm * 90.8 mm

Introduction:

The **SERVO-300** is a **3-axis**, command-based servo motor control board. The embedded CPU of the SERVO-300 performs the motion commands transferred from a Host PC via a 2 KB FIFO buffer. It also sends the position and status to the Host PC via a second 2 KB FIFO buffer. These buffers provide time buffer and they are very suitable for Windows operating systems. Device drivers and function libraries for DOS, Windows 7 and Windows XP/2000 are provided.

Software Support:

Windows Driver/DLL/Lib	Windows 95/98/ME/NT4.0
DOS Library	DOS 6.2
Labview Development Kit	-
Linux Library	-

Ordering Information/Accessories:

Model No.	Description
SERVO-300 CR	ISA Bus, 3-axis High-speed Servo Motor Control Card (V Command) Includes: CA-9-2502 (9-pin Male & 25-pin Female D-Sub Cable 0.2 M) CA-PC09F (9-pin Female D-Sub Connector with Plastic Cover) CA-PC09M (9-pin Male D-Sub Connector with Plastic Cover) CA-PC25M (25-pin Male D-Sub Connector with Plastic Cover)
DB-8R	Relay Board for SERVO-300 and PISO-PS300(U)
DB-200	Encoder Input Board for SERVO-300

Remote Motion Solutions



4. Remote Motion Solutions

Remote Motion Solutions	4-1
4.1 Ethernet Motion Control Solutions	4-1-1
ET-M8194H	4-1-3
4.2 Motionnet Solutions	4-2-1
PISO-MN200/PISO-MN200T	4-2-2
MN-SERVO Series	4-2-3
MN-SERVO EC Series	4-2-5
MN-2091U/MN-2091U-T	4-2-7
MN-3253/MN-3253T	4-2-9
MN-3254/MN-3254T	4-2-11
MN-3257/MN-3257T	4-2-13
4.3 CANopen Motion Solutions	4-3-1
PISO-CPM100U	4-3-3
I-7565-CPM	4-3-4
I-8123W	4-3-5



4. Remote Motion Solutions

Remote Motion Solutions



Vertical Market Focus:

Wafer Inspection, PCB Inspection, Plastic Surface Inspection, Drapery Inspection



4

Overview:

Wherever motion control solutions are required, ICP DAS provides a range of remote solutions that help users control and configure their motion I/O needs at remote sites, including PC, PLC, SCADA, etc. solutions. Currently, ICP DAS provides options for Ethernet, Motionnet and CANopen, etc. remote motion controls.

- **Ethernet Solutions: Ethernet Remote Motion Control**

ICP DAS provides Ethernet interface control based on the Modbus TCP protocol. As long as the remote sites with Modbus TCP client function, they can all be upgraded to have the capability of advanced motion control. In addition, ICP DAS also offers Ethernet security protection to prevent unauthorized access by other devices.

- **Motionnet Solutions: Motionnet Remote Motion Control**

Motionnet is a high-speed serial communication system that includes Master card and Slave modules. ICP DAS provides two categories of Slaves: the first is used for Digital I/O, and the other is used for motion control using these Slave devices, actuators/sensors can easily be directly connected. Motion control modules can be used together with either a Servo motor or a Stepping motor from a variety of vendors.

- **CANopen Solutions: CANopen Remote Motion Control**

The CAN (Controller Area Network) bus is one of the safest industrial network systems, and ICP DAS now provides a motion control library (CiA 402) for CANopen Master products meaning that users can now integrate motion control systems into a CANopen network.

Remote Motion Solutions Product List:		
Ethernet Solutions	ET-M8194H	Ethernet Remote Unit with High-speed 4-axis Motion Module
Motionnet Solutions	PISO-MN200(T)	PCI bus, Dual-line Motionnet Control Master Card
	MN-SERVO-xxx(-EC) Series	Distributed Motionnet Single-axis Motion Control Modules
	MN-2091U(-T)	Distributed Motionnet Single-axis Universal Motion Control Module
	MN-3254/3253/3257(T)	Distributed Motionnet Isolated DI/DO Modules
CANopen Solutions	PISO-CPM100U	CANopen PCI Master Cards
	I-7565-CPM	CANopen Converter
	I-8123W	CANopen Master Module
	CAN-8x23 & CAN-2000C Series	CANopen Remote I/O Expansion Unit & Remote I/O Modules

Remote Motion Solutions



4.1 Ethernet Motion Control Solutions

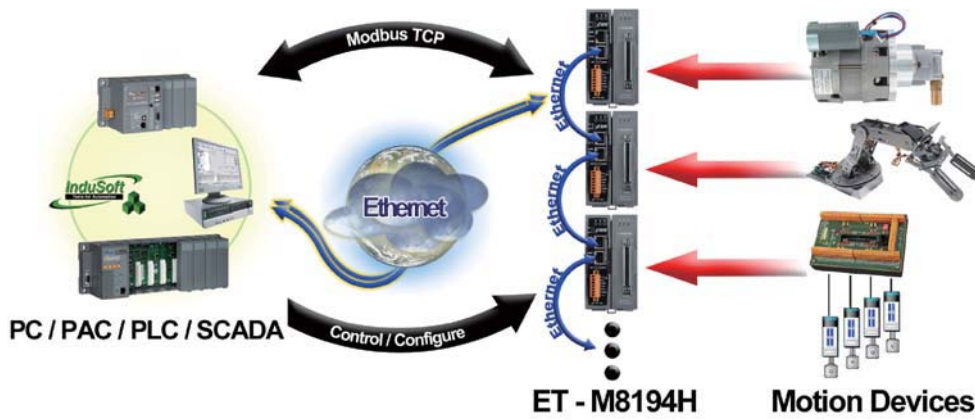

4

1

Remote Motion Solutions

Introduction:

The **ET-M8194H** is an Ethernet based 4-axis stepping/pulse-type motion controller that uses Modbus TCP/IP as a communication protocol between the client and the server. This intelligent motion controller also has many built-in motion control functions for doing 4-axis motion control, and is designed to act as a slave in a Modbus/TCP network. It supports all the standard Modbus functions and therefore can easily be integrated into an existing Modbus TCP network (for example, connected to a PC, HMI, PAC or PLC). Two or more ET-M8194H devices can be directly connected in series (daisy-chain topology) to eliminate the need for hubs or switches. An EzMove utility is provided to configure the ET-M8194H and assist the user in creating customized macro programs, ensuring rapid familiarization with the ET-M8194H and its motion commands. An API library for the Windows PC supports the development of more sophisticated motion control applications.

Ethernet Solution Products :

Ethernet Remote Unit	ET-M8194H	Ethernet Remote Unit with High-speed 4-axis Motion Control Module
----------------------	-----------	---

Application Notes:

In a recent case, ET-M8194H units were installed on machines performing IC inspection. Each machine was equipped with two ET-M8194H modules to coordinate six motors by taking advantage of the embedded Ethernet switching ports on the ET-M8194H. Therefore six axes motion control could be easily implemented by connecting two ET-M8194H modules in series (daisy-chain topology). The supervisory host PC was used to issue commands and collect information through the Ethernet without the need for additional wiring.

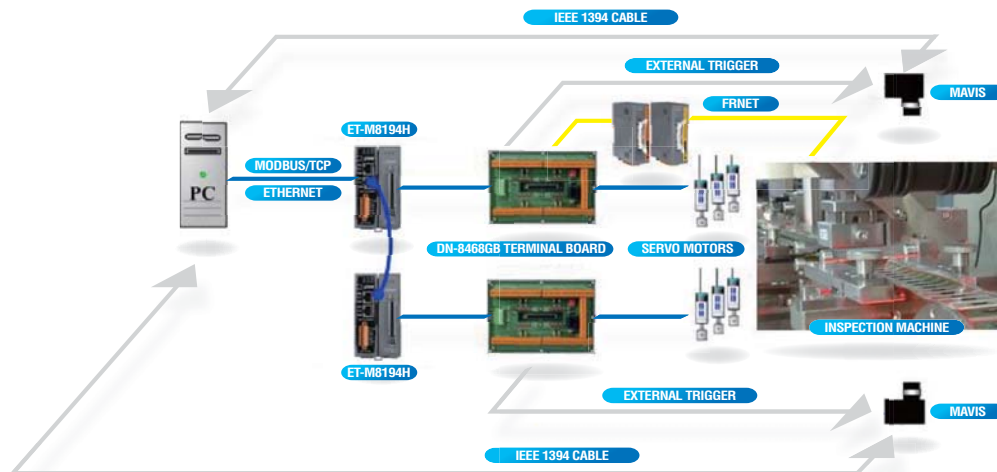

ET-M8194H Application Structure and Features:

- **Compact Size**
- **Easy to Use**
- **Stand-alone**

- Supports the Modbus TCP protocol
- Easy integration into a SCADA, PAC or PLC Modbus TCP network
- The device can be set as a remote or stand-alone motion controller
- Supports 4-axis motion control: 2/3-axis linear interpolation, etc.
- Supports high-speed FRnet I/O: 128 digital outputs and 128 digital inputs
- Supports macro programming
- Includes the EzMove utility for system configuration and macro program editing
- Supports FRnet DI or event triggered macro program execution
- Supports IP blocking

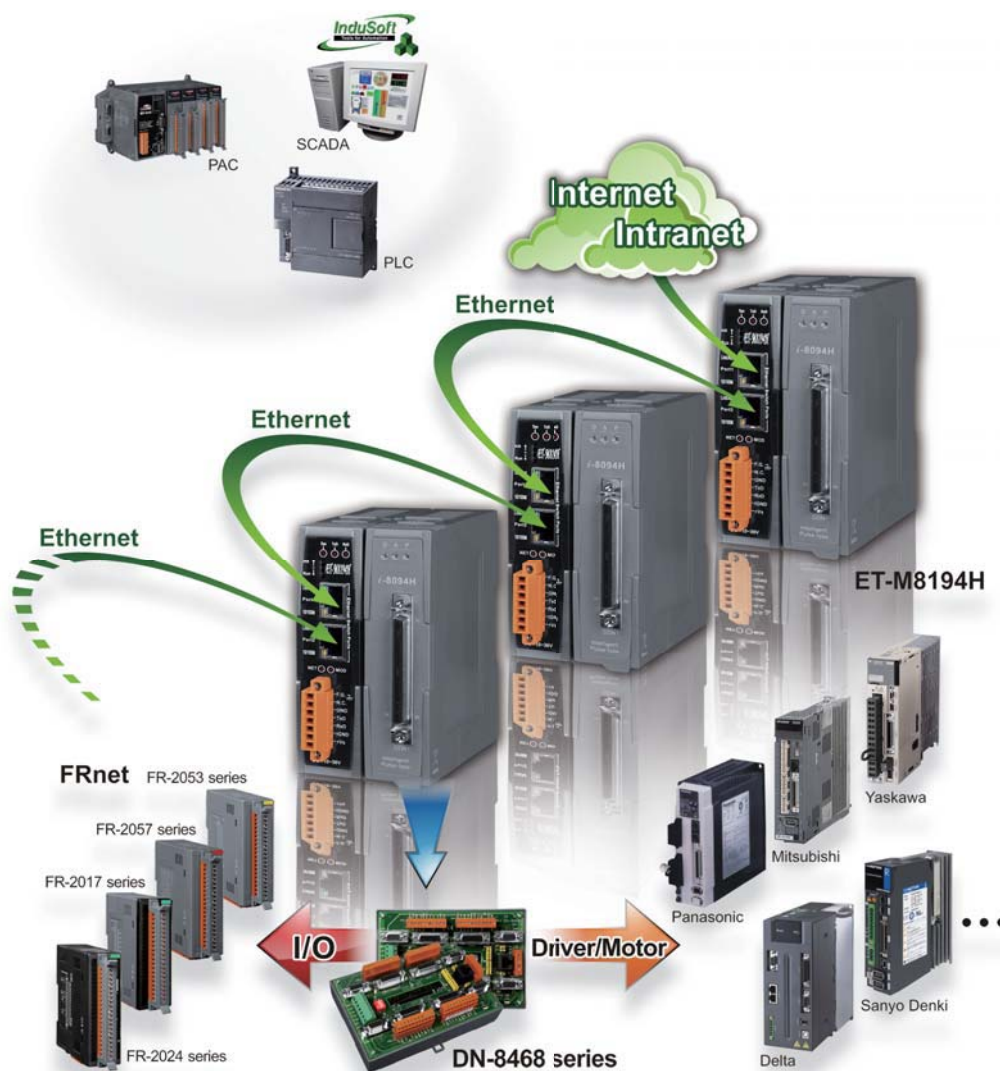

ET-M8194H

Ethernet Remote Unit with High-speed 4-axis Motion Control Module



Features:

- Remote control via Modbus TCP
- Can be controlled using SCADA, PAC or PLC, etc.
- Can be integrated into multi-station, multi-axis applications
- 4-axis motion control capability
- 2/3-axis Linear Interpolation Function
- 2-axis Circular Interpolation Function
- Programmable Automatic Homing function
- EzMove Utility for configuration and macro programming
- Test motion functions via EzMove without compilation
- API Library for rapid development of applications
- Easy wiring for multi-station applications
- IP_lock function for remote control security

4

Introduction:

1

The **ET-M8194H** is a new product from ICP DAS that can be used to implement remote control functionality via the Ethernet and includes an I-8094H module (a 4-axis stepping/pulse-type servo motor control module with an embedded CPU) and an Ethernet communication interface. The intelligent ET-M8194H can provide users with the ability to develop a wide range of remote motion control applications, and can be integrated in any system where the host platform is built on the Modbus TCP protocol (for example: PC, PAC or PLC). In addition, implementing a multi-station, multi-axis motion control solution can easily be achieved by cascading several ET-M8194H devices using Ethernet cables, either with or without Ethernet switches. ICP DAS also provides the EzMove Utility and an API Library that can be used to configure the ET-M8194H and to rapidly develop customized control applications.

Remote Motion Solutions

Hardware Interface:



ET-M8194H Interface Functions

Software Supported: ET-M8194H SDK

EzMove Utility

EzMove is a configuration utility developed by ICP DAS for the ET-M8194H controller. It is intended to perform motion control tasks and movement test on equipment without the need to first create customized applications. As the EzMove Utility is a Modbus client, it can be used to create and edit Macro Programs (MP), which can then be uploaded to the ET-M8194H. The EzMove Utility can also display and plot position/velocity of all four axes as well as display Modbus TCP messages for easy reference.



API Library

The ET-M8194H API Library is composed of nine groups of functions, which can be utilized to edit Macro Programs (MP) and send Modbus TCP commands required to control or configure the I-8094H. The library provides users with the ability to simultaneously control a large number of ET-M8194H from the PC.

DLL and libraries for the following development environments are provided:

- Visual C++
- BCB 5.0, 6.0
- C#, VB.NET
- Visual Basic 6.0

Specifications:

Interpolation Functions	Linear Interpolation (Interpolation Speed: 4 Mpps): 32-bit max. for any single command Circular Interpolation (Interpolation Speed: 4 Mpps): 32-bit max. for any single command Continuous Interpolation (Interpolation Speed: 2 Mpps): Yes
Drive Speed Curve	Maximum Drive Speed: 4 Mpps Constant Speed Driving Trapezoidal Acc/Dec Driving Asymmetrical Trapezoidal Driving S-curve Acc/Dec Driving Asymmetrical S-curve Driving
Position Control	Logic Position Counter/Bit Length for output pulse: 32-bit Real Position Counter/Bit Length for output pulse: 32-bit Position Compare Register Number/Axis: 2 Software Limit Position Counter Variable Ring
Auto-Home Search	Individual configuration (4-step) for each axis including irregular operation handling
Synchronous Action	10 activation factors (provocatives or events) and 14 actions
External Signal for Driving	Fixed/Continuous Pulse Output Manual Pulse
Other Functions	Drive Speed/Output Pulse Number Change during Driving Triangle Form Prevention of Speed Curve
Servo Motor Signal	Servo Ready and Alarm Input Signals/Axis Servo Enable Output/Axis
Other Input Signals	IN0 (Near Home), IN1 (Home), IN2 (Z-phase), IN3/Axis Emergency Signal
Input Signal Integral Type Filter	Filter Time Constant: 2 ~ 16 ms, 8 stages
Environmental	Operating Temperature: -20 ~ +75°C Storage Temperature: -30 ~ +85°C Operating Humidity: 10 ~ 85% RH, non-condensing Storage Humidity: 5 ~ 90% RH, non-condensing
FRnet Interface	Max. 128 DI and 128 DO channels Hardware auto-scan I/O every 0.72 ms Two-wire Serial Bus to reduce wiring needs Max. communication distance: 100 M A wide range of FRnet I/O terminal boards and modules are available

4

1

Remote Motion Solutions

Applications:

- | | |
|------------------------------|-------------------|
| ➔ X-Y-Z Table | ➔ Spinner |
| ➔ Fix-Pitch Stamping Machine | ➔ Loader/Unloader |
| ➔ Transfer Machine | |

Ordering Information/Accessories:

Model No.	Description
ET-M8194H	Ethernet Remote Automation Unit with High-speed 4-axis Motion Control Module
DN-8468UB	Photo-isolated Universal Snap-on Wiring Terminal Board
DN-8468GB	Photo-isolated General Purpose Wiring Terminal Board
DN-8468MB	Photo-isolated Snap-on Wiring Terminal Board for Mitsubishi MELSERVO-J2 Servo Amplifier
DN-8468PB	Photo-isolated Snap-on Wiring Terminal Board for Panasonic MINAS A4/A5 Servo Amplifier
DN-8468YB	Photo-isolated Snap-on Wiring Terminal Board for Yaskawa Sigma II/III/V Servo Amplifier
DN-8468DB	Photo-isolated Snap-on Wiring Terminal Board for Delta ASDA-A Servo Amplifier
DN-8468FB	Photo-isolated Snap-on Wiring Terminal Board for Fuji FALDIC-W Servo Amplifier
CA-SCSI15-H / CA-SCSI30-H / CA-SCSI50-H	68-pin SCSI-II Connector Cable; Length 1.5 M / 3.0 M / 5.0 M

4.2 Motionnet Solutions

Introduction:

Motionnet is a high-speed serial communication system that includes a Master card and Slave modules. ICP DAS provides two categories of Slaves: the first is used for Digital I/O, and the other is used for motion control. There are 3 main types of digital I/O modules: 32-ch Input, 32-ch Output and 16-ch Input/Output. Using these Slave devices, customers' actuators/sensors can easily be directly connected. Motion control modules can be used together with either a Servo motor or a Stepping motor from a variety of vendors.

Motionnet communication between a Master and the Slaves is based on a proprietary RS-485 technology (Multi-drop, Half-duplex) and provides the advantage of reduced wiring requirements together with the capability of long-distance and high-speed communication. Data transfer for the I/O modules is cyclical and time deterministic, so can be widely used for industrial automation applications.

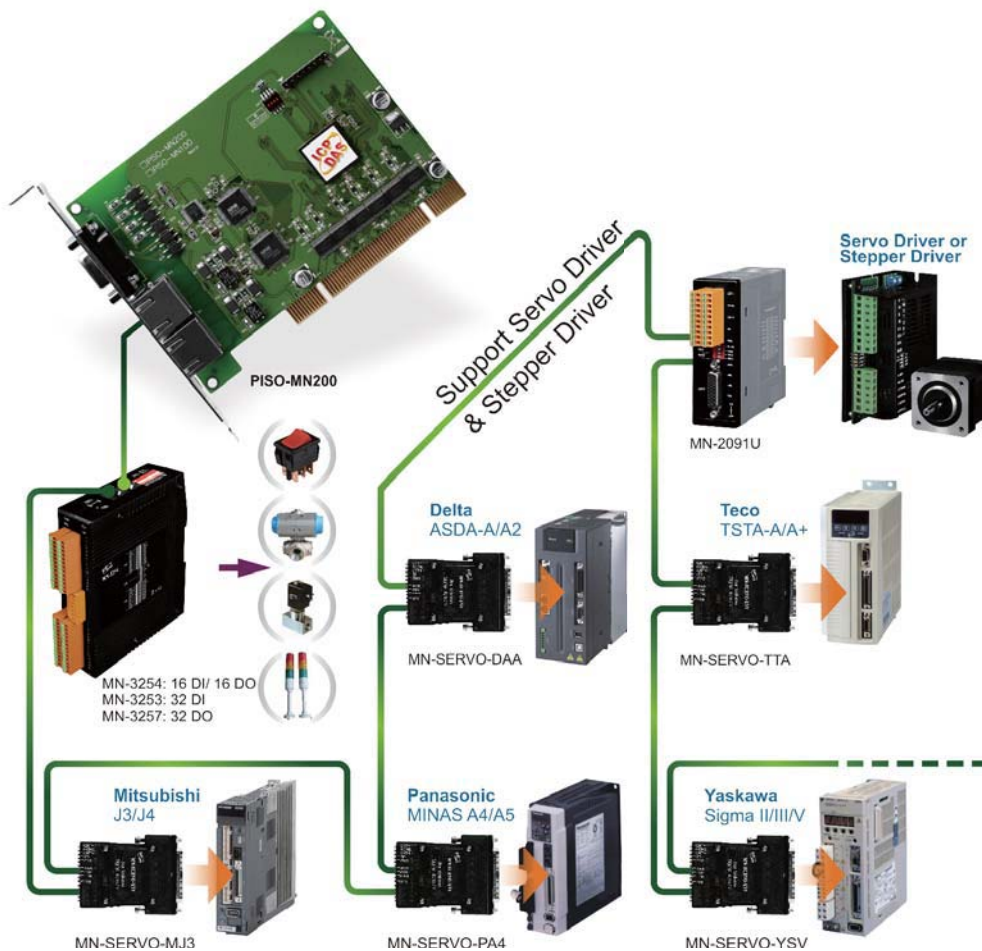

Features:

- Communication Speed: Max. 20 Mbps
- Communication Distance: Max. 100 m
- Controllable Modules: 64 modules per line
- Data Transfer Rate: 15.1 μ sec/module (each module provides 32 I/O points)
2048 points in 0.97 ms (when 64 modules are connected)

PISO-MN200/PISO-MN200T

PCI Bus, Dual-line Motionnet Master Card (For Distributed Motion & I/O Control)

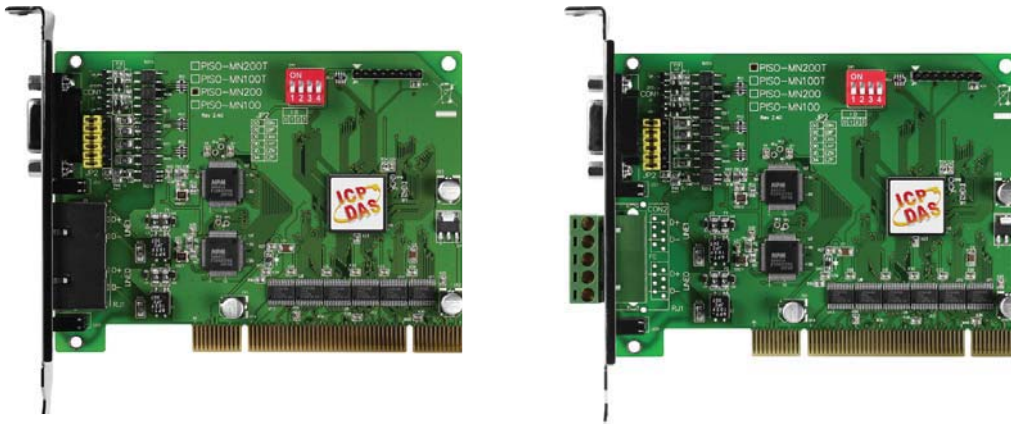

Introduction:

The **PISO-MN200(T)** is a PCI Master card that provides two Motionnet serial communication lines for distributed motion and I/O control in machine automation applications. The Master card can be used to connect up to 128 Slave modules (64 x 2 lines). If one of the Motionnet lines is only used for I/O control, it can send/receive signals to/from 2048 points on 64 local devices within 0.97 msec. When it is used to control motors, it can control up to 64 axes, which can be used to execute continuous positioning motion, zero return and even multi-axis interpolation operations. In addition to serial communication, the PISO-MN200(T) is also equipped with parallel I/O ports (8 input channels and 4 output channels) for rapid and instinctive I/O control.

Specifications:

Bus	32-bit/33 MHz universal PCI-Bus
Communication Speed	2.5, 5, 10, 20 Mbps (Software controlled)
Interface	Half-duplex RS-485
Communication Length	Max. 100 M (20 Mbps; 32 Slave modules) Max. 50 M (20 Mbps; 64 Slave modules) Max. 100 M (10 Mbps; 64 Slave modules)
Communication Connector	PISO-MN200: RJ-45 x 2 PISO-MN200T: 5-pin terminal block
I/O Connector	HD D-Sub 15-pin x 1
Parallel I/O	Digital input: 8-ch Photo-coupler Isolated (12-24 V, NPN or PNP) Digital output: 4-ch Photo-coupler Isolated (NPN or PNP)
LED Diagnostics	Connection (green) Communication Error (red)
Interrupts	Input Change of State Communication Error
Operating Temp.	0 ~ +60 °C
Storage Temp.	-20 ~ +80 °C
Operating Humidity	10 ~ 85%; non-condensing
Storage Humidity	5 ~ 95%; non-condensing

Features:

- Maximum Communication Speed: 20 Mbps
- Distributed motion control up to 128 axes
- Distributed I/O points up to 4096 points
- Easy connection using RJ-45 phone jack or removable terminal block
- Parallel I/O Ports: 8 Input and 4 Output channels
- Optional quadrature encoder input for linear scale or manual pulse generator input

Software Support:

Windows Driver/DLL/Lib	Windows 7 32/64-bit Windows XP/2000 32-bit
Programming Tools	VC/VB/BCB

Ordering Information/Accessories:

Model No.	Description
PISO-MN200 CR	PCI Bus, Dual-line Motionnet Master Card with RJ-45 (RoHS)
PISO-MN200T CR	PCI Bus, Dual-line Motionnet Master Card with Terminal Block (RoHS)
MN-SERVO CR Series MN-SERVO EC CR Series	Distributed Motionnet Single-axis Motion Control Modules (With Spring Type Terminal Blocks; EC: with e-CON Mini-Clamp connector) (RoHS)
MN-2091U CR MN-2091U-T CR	Distributed Motionnet Single-axis Universal Motion Control Modules (RoHS)
MN-3254 CR MN-3254T CR	Distributed Motionnet 16-ch Isolated DI, 16-ch Isolated DO Module (RoHS)
MN-3253 CR MN-3253T CR	Distributed Motionnet 32-ch Isolated DI Module (RoHS)
MN-3257 CR MN-3257T CR	Distributed Motionnet 32-ch Isolated DO Module (RoHS)

MN-SERVO Series

MN-SERVO-MJ3 / MN-SERVO-PA4 / MN-SERVO-YSV /
MN-SERVO-DAA / MN-SERVO-TTA

Distributed Motionnet Single-axis Motion Control Modules (With Spring Type Terminal Blocks)



Features:

- Maximum communication speed: 20 Mbps
- Maximum pulse output frequency: 6.6 Mpps
- Control up to 64 axes per line
- Multi-axis linear interpolation function
- 2-axis circular interpolation function
- Programmable T/S-curve acceleration and deceleration
- Change speed and position on the fly
- Slow down sensor, home sensor, positive and negative limit sensors for each axis
- Software limit and compare trigger output
- Three-way isolation for power, communication and I/O. (Provide better noise immunity and device protection)
- The standard module equipped with Terminal Blocks for easy wiring (additional terminal board is not required)

4

2

Remote Motion Solutions

Introduction:

The **MN-SERVO** series is used to expand the number of axes for distributed motion control in Motionnet field bus. These extension slave modules can be directly plugged into the servo driver and being connected serially to the controller by a simple and affordable Cat.5 LAN cable, reducing the wiring effort between drivers and controller. This is very suitable for highly integrated machine automation applications.

After the module is plugged into the servo driver, all you need to do is make the serial LAN cable connect between the modules. One serial line can support up to 64 single-axis modules. ICP DAS provides a variety of motion control modules suitable for a range of brands of servo drivers, such as Mitsubishi MELSERVO-J3/J4, Yaskawa Sigma II/III/V, Panasonic MINAS A4/A5, Delta ASDA-A/A2 and Teco TSTA-A/A+.

Specifications:

Communication Speed	2.5, 5, 10, 20 Mbps
Maximum Pulse Output Frequency	6.6 Mpps
Pulse Output Interface	OUT/DIR, CW/CCW
Pulse Output Counter	28-bit
Encoder Interface	CW/CCW, A/B phase
Encoder Counter	28-bit
Speed Profile	Trapezoidal/S Shaped Acc/Dec Driving
Home Mode	13 Types
Mechanical Switch Input	LMT+, LMT-, HOME, SD, EMG
Servo I/O Interface	Input: ALM, RDY, INP Output: SVON, ERC, ALM_RST
High-Speed Position Compare Output	5 V TTL or 24 V open collector
Led Diagnostics	Communication state (Link, Error) Mechanic Switch Input Internal 3.3 V Power Termination Resistor Switch
Operating Temperature	0 ~ +60 °C
Storage Temperature	-20 ~ +80 °C
Operating Humidity	10 ~ 85%; non-condensing
Storage Humidity	5 ~ 95%; non-condensing

Pin Assignments:

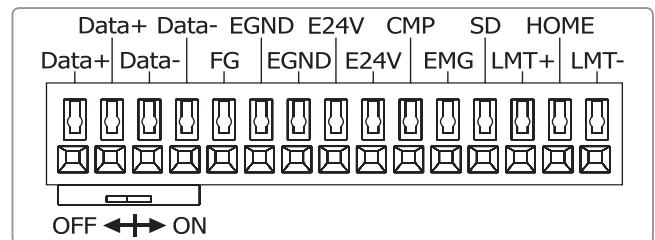

No.	Name	Description	Signal Direction
1 ~ 2	Data+	Serial communication data+	Both
3 ~ 4	Data-	Serial communication data-	Both
5	FG	Frame ground	None
6 ~ 7	EGND	External ground	Input
8 ~ 9	E24V	External power 24V	Input
10	CMP	High-speed position compare	Output
11	EMG	Emergency stop	Input
12	SD	Slowdown	Input
13	LMT+	Positive end limit	Input
14	HOME	Home position	Input
15	LMT-	Negative end limit	Input

Wire Range: 28~20 AWG
Wire Strip Length: 10 mm

Dimensions: (Units: mm)

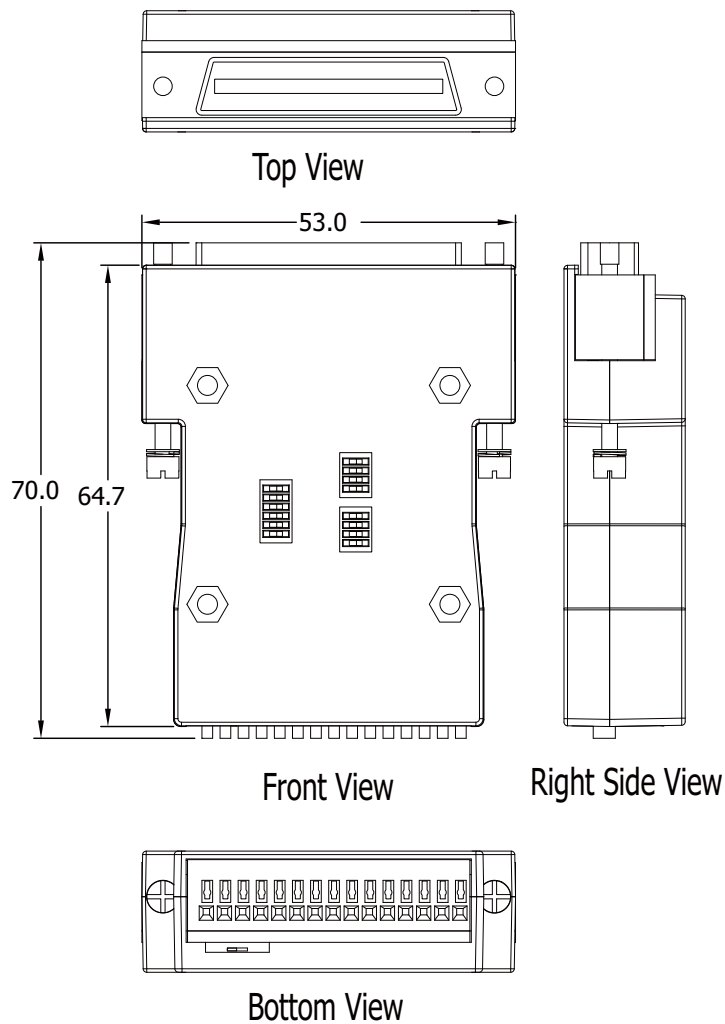

4

2

Remote Motion Solutions

Ordering Information:

Model No.	Description
MN-SERVO-MJ3 CR	Distributed Motionnet Single-axis Motion Control Module with Spring Type Terminal Blocks for Mitsubishi MELSERVO-J3/J4 (RoHS)
MN-SERVO-PA4 CR	Distributed Motionnet Single-axis Motion Control Module with Spring Type Terminal Blocks for Panasonic MINAS A4 (RoHS)
MN-SERVO-YSV CR	Distributed Motionnet Single-axis Motion Control Module with Spring Type Terminal Blocks for Yaskawa Sigma II/III/V (RoHS)
MN-SERVO-DAA CR	Distributed Motionnet Single-axis Motion Control Module with Spring Type Terminal Blocks for Delta ASDA-A/A2 (RoHS)
MN-SERVO-TTA CR	Distributed Motionnet Single-axis Motion Control Module with Spring Type Terminal Blocks for Teco TSTA-A/A+ (RoHS)
MN-3254/MN-3253/MN-3257 CR MN-3254T/MN-3253T/MN-3257T CR	Distributed Motionnet 16-ch Isolated DI and 16-ch Isolated DO / 32-ch Isolated DI / 32-ch Isolated DO Module (RoHS)
PISO-MN200 CR PISO-MN200T CR	PCI Bus, Dual-line Motionnet Control Master Card (RoHS)

Model No.	Description
4POPP-003F	Pink Cord-End Terminal
4POPP-003G	Turquoise Cord-End Terminal

MN-SERVO EC Series

**MN-SERVO-MJ3-EC / MN-SERVO-PA4-EC / MN-SERVO-YSV-EC/
MN-SERVO-DAA-EC / MN-SERVO-TTA-EC**

Distributed Motionnet Single-axis Motion Control Modules (With *e-CON* Mini-Clamp Connector)



Features:

- Maximum communication speed: 20 Mbps
- Maximum pulse output frequency: 6.6 Mpps
- Control up to 64 axes per line
- Multi-axis linear interpolation function
- 2-axis circular interpolation function
- Programmable T/S-curve acceleration and deceleration
- Change speed and position on the fly
- Slow down sensor, home sensor, positive and negative limit sensors for each axis
- Software limit and compare trigger output
- Three-way isolation for power, communication and I/O. (Provide better noise immunity and device protection)
- The EC module equipped with Mini-Clamp connector provide for an easier and debris-free wire termination process.

4

2

Remote Motion Solutions

Introduction:

The **MN-SERVO-xxx-EC series** is used to expand the number of axes for distributed motion control on a Motionnet field bus. These extension slave modules can be directly connect to the servo driver and are serially connected to the controller using a simple and affordable Cat.5 LAN cable, reducing the amount of wiring required between the drivers and the controller, making this a highly suitable solution for integrated machine automation applications.

After the module is connected to the servo driver, all you need to do is connect a serial LAN cable between the modules. One serial line can support up to 64 single-axis modules. ICP DAS provides a variety of motion control modules suitable for a range of brands of servo drivers, such as Mitsubishi MELSERVO-J3/J4, Yaskawa Sigma II/III/V, Panasonic MINAS A4/A5, Delta ASDA-A/A2 and Teco TSTA-A/A+.

Specifications:

Communication Speed	2.5, 5, 10, 20 Mbps
Maximum Pulse Output Frequency	6.6 Mpps
Pulse Output Interface	OUT/DIR, CW/CCW
Pulse Output Counter	28-bit
Encoder Interface	CW/CCW, A/B phase
Encoder Counter	28-bit
Speed Profile	Trapezoidal/S Shaped Acc/Dec Driving
Home Mode	13 Types
Mechanical Switch Input	LMT+, LMT-, HOME, SD, EMG
Servo I/O Interface	Input: ALM, RDY, INP Output: SVON, ERC, ALM_RST
High-Speed Position Compare Output	5 V TTL or 24 V open collector
Led Diagnostics	Communication state (Link, Error) Mechanic Switch Input Internal 3.3 V Power Termination Resistor Switch
Operating Temperature	0 ~ +60 °C
Storage Temperature	-20 ~ +80 °C
Operating Humidity	10 ~ 85%; non-condensing
Storage Humidity	5 ~ 95%; non-condensing

Pin Assignments:

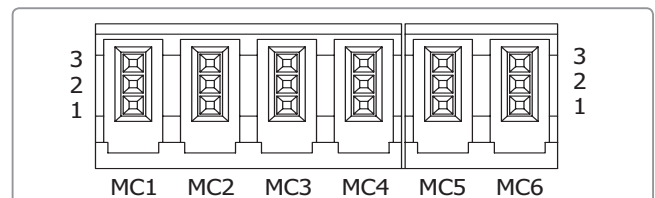

Connector	No.	Name	Description	Signal Direction
MC1	3	Data-	Serial communication data-	Both
	2	Data+	Serial communication data+	Both
	1	F.G.	Frame ground	None
MC2	3	Data-	Serial communication data-	Both
	2	Data+	Serial communication data+	Both
	1	F.G.	Frame ground	None
MC3	3	E24V	External power 24V	Input
	2	EGND	External ground	Input
	1	F.G.	Frame ground	None
MC4	3	E24V	External power 24V	Input
	2	EGND	External ground	Input
	1	F.G.	Frame ground	None
MC5	3	CMP	High-speed position compare	Output
	2	EMG	Emergency stop	Input
	1	SD	Slowdown	Input
MC6	3	LMT+	Positive end limit	Input
	2	HOME	Home position	Input
	1	LMT-	Negative end limit	Input

Dimensions: (Units: mm)

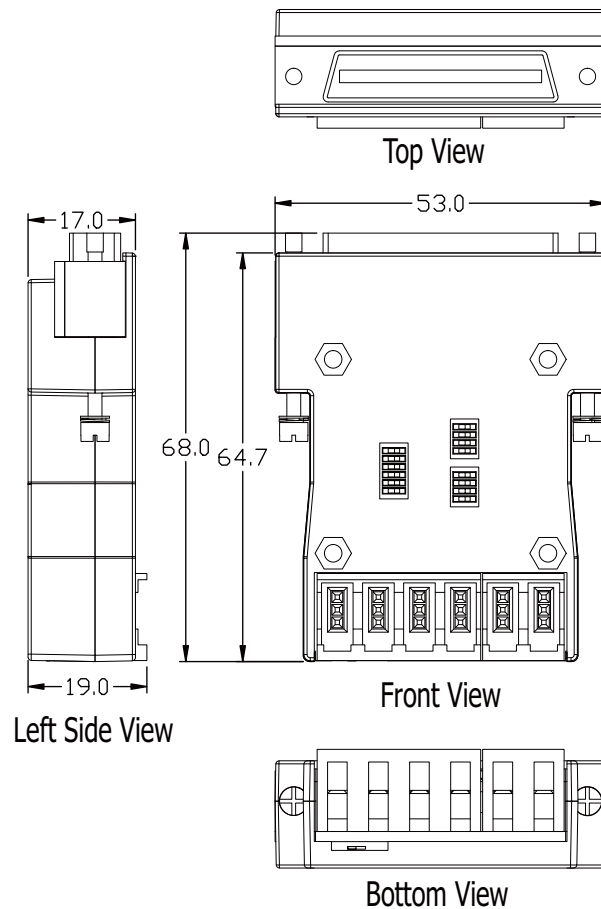

4

2

Remote Motion Solutions

Ordering Information:

Model No.	Description
MN-SERVO-MJ3-EC CR	Distributed Motionnet Single-axis Motion Control Module with e-CON Mini-Clamp connector for Mitsubishi MELSERVO-J3/J4 (RoHS)
MN-SERVO-PA4-EC CR	Distributed Motionnet Single-axis Motion Control Module with e-CON Mini-Clamp connector for Panasonic MINAS A4 (RoHS)
MN-SERVO-YSV-EC CR	Distributed Motionnet Single-axis Motion Control Module with e-CON Mini-Clamp connector for Yaskawa Sigma II/III/V (RoHS)
MN-SERVO-DAA-EC CR	Distributed Motionnet Single-axis Motion Control Module with e-CON Mini-Clamp connector for Delta ASDA-A/A2 (RoHS)
MN-SERVO-TTA-EC CR	Distributed Motionnet Single-axis Motion Control Module with e-CON Mini-Clamp connector for Teco TSTA-A/A+ (RoHS)
MN-3254/MN-3253/MN-3257 CR MN-3254T/MN-3253T/MN-3257T CR	Distributed Motionnet 16-ch Isolated DI and 16-ch Isolated DO / 32-ch Isolated DI / 32-ch Isolated DO Module (RoHS)
PISO-MN200 CR PISO-MN200T CR	PCI Bus, Dual-line Motionnet Control Master Card (RoHS)

Mini Clamp Wiremount Plug			Applicable Wire		
ICP DAS Part No.	Cover Color	3M Part No.	AWG No.	Cross-sectional Area (mm ²)	Finished External Diameter Φ (mm)
4PKD1O0000001	Gray	37103-2206-000FL	20 – 22	0.3 – 0.5	1.6 – 2.0
4PKD1O0000002	Red	37103-3101-000FL	24 – 26	0.14 – 0.3	0.8 – 1.0
4PKD1O0000003	Orange	37103-3163-000FL	24 – 26	0.14 – 0.3	1.2 – 1.6

MN-2091U/MN-2091U-T

Distributed Motionnet Single-axis Universal Motion Control Module



Features:

- Maximum communication speed: 20 Mbps
- Maximum pulse output frequency: 6.6 Mpps
- Control up to 64 axes per line
- Multi-axis linear interpolation function
- 2-axis circular interpolation function
- Programmable T/S-curve acceleration and deceleration
- Change speed and position on the fly
- Slow down sensor, home sensor, positive and negative limit sensors for each axis
- Software limit and compare trigger output
- Three-way isolation for power, communication and I/O. (Provide better noise immunity and device protection)
- Suitable for controlling a variety of servo drivers and stepper drivers

4

Introduction:

The **MN-2091U(-T)** is used to expand the number of axes for distributed motion control on a Motionnet field bus. These extension slave modules are serially connected to the controller using a simple and affordable Cat.5 LAN cable, and one serial line can support up to 64 single-axis modules. The 26-pin HD D-Sub connector can be used to easily connect with various servo drivers and stepper drivers. ICP DAS also provides a variety of cables suitable for a range of brands of servo drivers, which further reduces the amount of wiring required between the drivers and the controller, making this an ideal solution for highly integrated machine automation applications.

2

Remote Motion Solutions

Specifications:

Communication Speed	2.5, 5, 10, 20 Mbps
Maximum Pulse Output Frequency	6.6 Mpps
Pulse Output Interface	OUT/DIR, CW/CCW
Pulse Output Counter	28-bit
Encoder Interface	CW/CCW, A/B phase
Encoder Counter	28-bit
Speed Profile	Trapezoidal/S-shaped Acc/Dec Driving
Home Mode	13 Types
Mechanical Switch Input	LMT+, LMT-, HOME, SD, EMG
Servo I/O Interface	Input: ALM, RDY, INP Output: SVON, ERC, ALM_RST
High-Speed Position Compare Output	5V TTL or 24V open collector
LED Diagnostics	Communication state (Link, Error) Mechanic Switch Input Internal 3.3V Power Termination Resistor Switch
Communication Connector	MN-2091U: RJ-45 x2 MN-2091U-T: 5-pin terminal block
Operating Temperature	0 ~ +60 °C
Storage Temperature	-20 ~ +80 °C
Operating Humidity	10 ~ 85%; non-condensing
Storage Humidity	5 ~ 95%; non-condensing

Dimensions: (Units: mm)

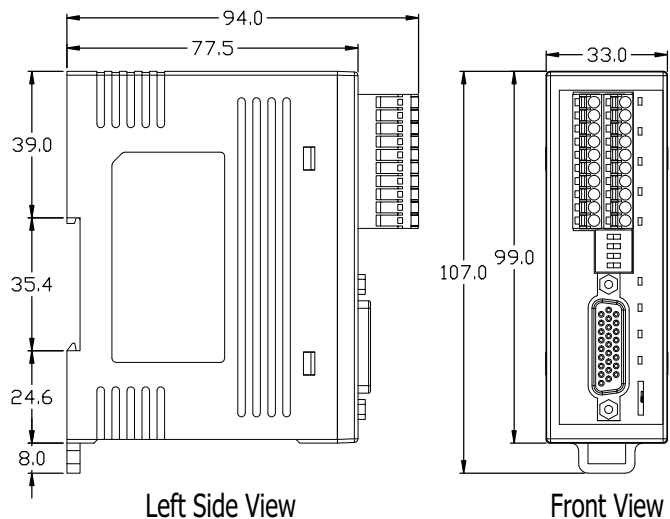

Bottom View

Pin Assignments:

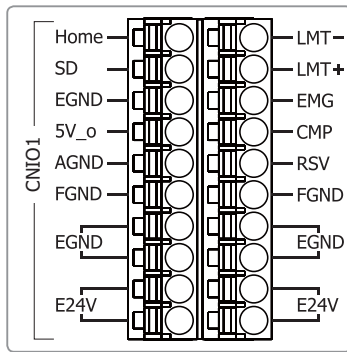

Pin No.	Pin Name	Description	I/O Define.	Pin No.	Pin Name	Description	I/O Define.
CNIO1B (Left) Pin Assignments				CNIO1A (Right) Pin Assignments			
1	HOME	Home position	Input	1	LMT-	Negative end limit	Input
2	SD	Slowdown	Input	2	LMT+	Positive end limit	Input
3	EGND	External ground	Input	3	EMG	Emergency stop	Input
4	5V_o	Internal 5V power derived from 24V supply	Output	4	CMP	High-speed position compare	Output
5	AGND	Optional analog ground, no internal connection	Connect to CM1 only	5	RSV	Reserved signal (no internal connection)	Connect to CM1 only
6	FGND	Frame ground	None	6	FGND	Frame ground	None
7 ~ 8	EGND	External ground	Input	7 ~ 8	EGND	External ground	Input
9 ~ 10	E24V	External power 24V	Input	9 ~ 10	E24V	External power 24V	Input

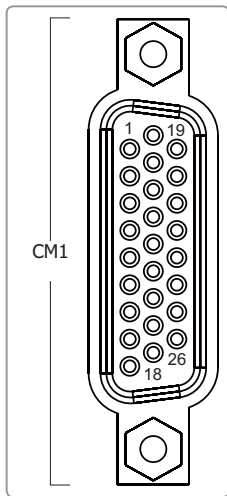

Pin No.	Pin Name	Description	I/O Define.	Pin No.	Pin Name	Description	I/O Define.
1	SRV_ON	Servo On	Output	15	AGND	Optional analog ground (no internal connection)	Connect to CNIO1 only
2	INP	In Position	Input	16	B-	Encoder B-phase pulse	Input
3	ERC	Error Counter Clear	Output	17	B+	Encoder B-phase pulse	Input
4	RDY	Servo Ready	Input	18	N.C.	No internal connection	N.C.
5	P-	Forward rotation pulse train (differential line driver)	Output	19	EMG	Emergency stop	Input
6	P+		Output	20	RSV	Reserved signal (no internal connection)	Connect to CNIO1 only
7	A-	Encoder A-phase pulse	Input	21	EGND	External ground	Input
8	A+		Input	22	EGND	External ground	Input
9	N.C.	No internal connection	N.C.	23	N-	Forward rotation pulse train (differential line driver)	Output
10	RESET	Alarm Reset	Output	24	N+		Output
11	ALARM	Servo Alarm	Input	25	Z-	Encoder Z-phase pulse	Input
12	E24V	External power 24V	Input	26	Z+	Encoder Z-phase pulse	Input
13	EGND	External ground	Input				
14	N.C.	No internal connection	N.C.				

Ordering Information:

Model No.	Description
MN-2091U CR	Distributed Motionnet Single-axis Universal Motion Control Module with RJ-45 Connector (RoHS)
MN-2091U-T CR	Distributed Motionnet Single-axis Universal Motion Control Module with Terminal Block (RoHS)
MN-SERVO CR Series MN-SERVO EC CR Series	Distributed Motionnet Single-axis Motion Control Modules (with Spring Type Terminal Blocks; EC: with e-CON Mini-Clamp Connector) (RoHS)
MN-3254/MN-3253/MN-3257 CR MN-3254T/MN-3253T/MN-3257T CR	Distributed Motionnet 16-ch Isolated DI and 16-ch Isolated DO / 32-ch Isolated DI / 32-ch Isolated DO Module (RoHS)
PISO-MN200 CR PISO-MN200T CR	PCI Bus, Dual-Line Motionnet Master Control Card (RoHS)

Accessories:

Model No.	Description
CA-PC26M	26-pin HD D-Sub solder cup Male connector with plastic cover
CA-26-DAB2-15/30/50	26-pin HD D-Sub Male cable for Delta B2 servo amplifier, 1.5/3/5 M (for ASDA-B2 series)
CA-26-FFW-15/30/50	26-pin HD D-Sub Male cable for Fuji servo amplifier, 1.5/3/5 M (for FALDIC-W and ALPHA5 Smart series)
CA-26-MJ3-15/30/50	26-pin HD D-Sub Male cable for Mitsubishi servo amplifier, 1.5/3/5 M (for MELSERVO-J3/J4 series)
CA-26-YSV-15/30/50	26-pin HD D-Sub Male cable for Yaskawa servo amplifier, 1.5/3/5 M (for Sigma II/III/V series)
CA-26-PA4-15/30/50	26-pin HD D-Sub Male cable for Panasonic servo amplifier, 1.5/3/5 M (for MINAS A4/A5 series)
CA-26-DAA2-15/30/50	26-pin HD D-Sub Male cable for Delta A2 servo amplifier, 1.5/3/5 M (for ASDA-A2 series)
CA-26-TTA-15/30/50	26-pin HD D-Sub Male cable for Teco servo amplifier, 1.5/3/5 M (for TSTA-A/A+ series)

MN-3253/MN-3253T

Distributed Motionnet 32-ch Isolated DI Module



Features:

- Maximum communication speed: 20 Mbps
- 32-ch isolated digital inputs
- Each Motionnet transfer Line: connect modules up to 64
- Designing isolation protection: power, communication, I/O
- LED Diagnostics for communication and I/O status
- Each port can be specified as NPN or PNP (12~24 V)

4

2

Remote Motion Solutions

Introduction:

The **MN-3253(T)** is an I/O expansion device for Motionnet systems, and is equipped with **32 isolated digital input channels**. Each Motionnet communication line can be connected to up to 64 modules, meaning that the I/O can be expanded to up to 2048 input channels. The communication time required by each **MN-3253(T)** is 15.1 us. If 64 modules have been connected, signals for 2048 points on 64 modules can be sent and received within 0.97 msec. The update of the I/O status is completed automatically through the Motionnet system at a constant interval, and setting interrupts for specific input points that the customer wants to monitor can help prevent CPU time from being wasted by repetitive polling when there is nothing else for the issuing process to do. Each input port can be specified as either NPN or PNP (12~24 V).

Specifications:

Digital Input	
Input Channels	32
Input Type	Sink/Source (NPN/PNP)
On Voltage Level	+10 ~ 30 VDC
Off Voltage Level	+3 VDC max.
Input Impedance	4.7K Ohm
Isolation Voltage	3000 Vrms
Interface	
LED Indicators	Communication state (Link, Error) Input/output state Internal 3.3 V Power Termination resistor switch
Communication Speed	Selectable 2.5, 5, 10 or 20 Mbps by DIP Switch.
Cyclic Scan Time	15.1 μ s per device (20 Mbps)
Communication Connector	MN-3253: RJ-45 x 2 MN-3253T: 5-pin terminal block
I/O Connector	13-Pin pluggable Terminal block x 4

Power	
Voltage Range	24 VDC (1000 V isolated)
Power Consumption	2 W max.
Protection	Reverse voltage and overcurrent protection
Connection	7-pin removable terminal block
Mechanical	
Case	Plastic
Flammability	UL94V-0 materials
Dimensions (W x H x D)	31 mm x 140 mm x 126.6 mm
Installation	DIN-Rail mounting
Environmental	
Operating Temperature	0 ~ + 60°C
Storage Temperature	-20 ~ +80°C
Operating Humidity	10 ~ 85%; Non-condensing
Storage Humidity	5 ~ 95%; Non-condensing

Pin Assignments:

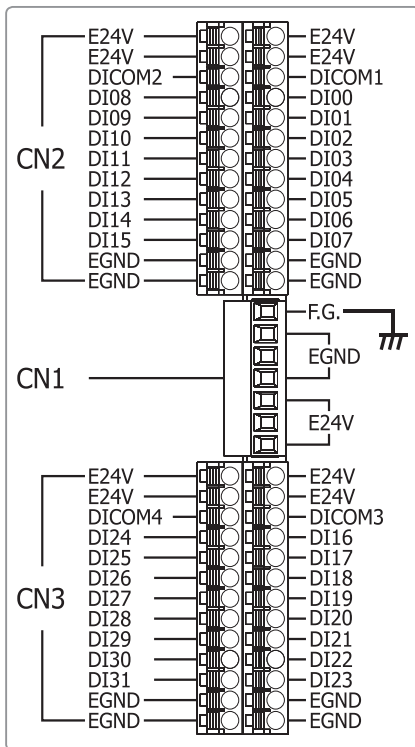

NO.	Pin Define	Specifications	I/O Define
CN1 Pin Assignments			
1	FG	Frame Ground	-
2 ~ 4	EGND	External Ground	Input
5 ~ 7	E24V	External 24V(+)	Input
CN2A (Right) Pin Assignments			
1 ~ 2	E24V	External 24V(+)	Connect to CN1
3	DICOM1	Common terminal of DI00~DI07	Input
4 ~ 11	DI00~DI07	Digital input channels 00~07	Input
12 ~ 13	EGND	External Ground	Connect to CN1
CN2B (Left) Pin Assignments			
1 ~ 2	E24V	External 24V(+)	Connect to CN1
3	DICOM2	Common terminal of DI08~DI15	Input
4 ~ 11	DI08~DI15	Digital input channels 08~15	Input
12 ~ 13	EGND	External Ground	Connect to CN1
CN3A (Right) Pin Assignments			
1 ~ 2	E24V	External 24V(+)	Connect to CN1
3	DICOM3	Common terminal of DI16~DI23	Input
4 ~ 11	DI16~DI23	Digital input channels 16~23	Input
12 ~ 13	EGND	External Ground	Connect to CN1
CN3B (Left) Pin Assignments			
1 ~ 2	E24V	External 24V(+)	Connect to CN1
3	DICOM4	Common terminal of DI24~DI31	Input
4 ~ 11	DI24~DI31	Digital input channels 24~31	Input
12 ~ 13	EGND	External Ground	Connect to CN1

Dimensions: (Units: mm)

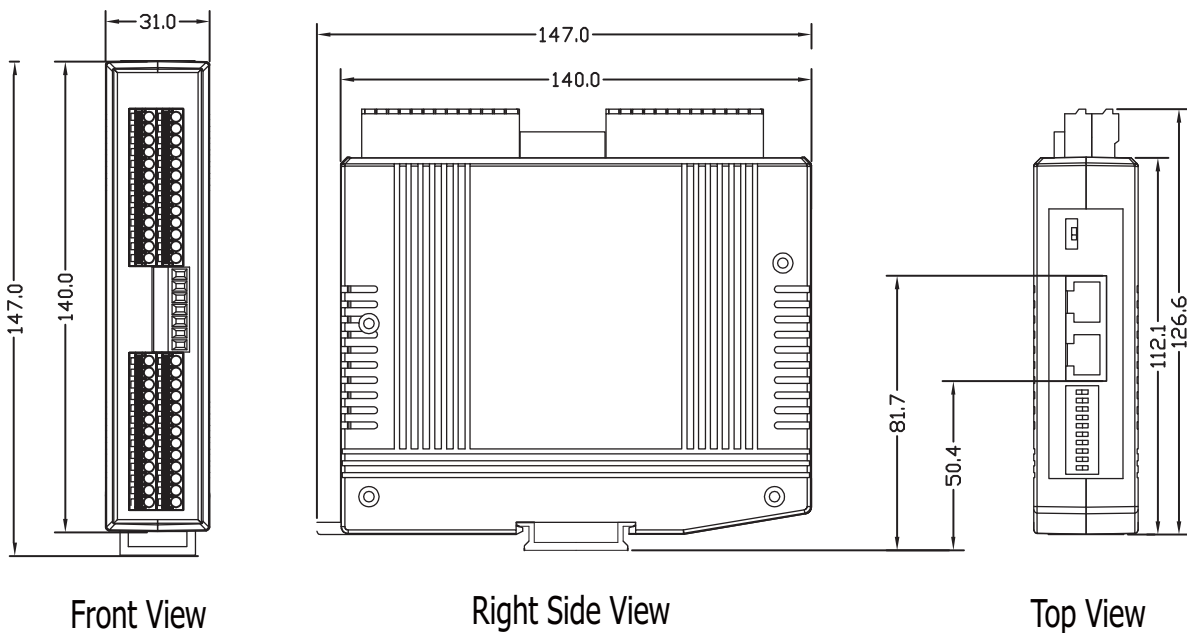

Front View

Right Side View

Top View

Ordering Information/Accessories:

Model No.	Description
MN-3253 CR	Distributed Motionnet 32-ch Isolated DI Module with RJ-45 Connector (RoHS)
MN-3253T CR	Distributed Motionnet 32-ch Isolated DI Module with Terminal Block (RoHS)
PISO-MN200 CR PISO-MN200T CR	PCI Bus, Dual-Line Motionnet Master Control Card (RoHS)
MN-SERVO CR Series MN-SERVO EC CR Series	Distributed Motionnet Single-axis Motion Control Modules (with Spring Type Terminal Blocks; EC: with e-CON Mini-Clamp Connector) (RoHS)
MN-2091U CR MN-2091U-T CR	Distributed Motionnet Single-axis Universal Motion Control Module (RoHS)

MN-3254/MN-3254T

Distributed Motionnet 16-ch Isolated DI, 16-ch Isolated DO Module



Features:

- Maximum communication speed: 20 Mbps
- 16-ch isolated digital inputs, 16-ch isolated digital outputs
- Each Motionnet transfer line: connect modules up to 64
- Designing isolation protection: power, communication, I/O
- LED Diagnostics for communication and I/O status
- Each input port can be specified as NPN or PNP (12~24 V)
- The internal flywheel diode of each output ports can be connect to different sources of power individually.
- High current sinking capability (200 mA)

4

2

Remote Motion Solutions

Introduction:

The **MN-3254(T)** is an I/O expansion device for Motionnet systems, and is equipped with **16 isolated digital input channels and 16 isolated digital output channels**. Each Motionnet communication line can be connected to up to 64 modules, meaning that the I/O can be expanded to up to 1024 input channels and 1024 output channels. The communication time required by each MN-325x is 15.1 us. If 64 modules have been connected, signals for 2048 points on 64 modules can be sent and received within 0.97 msec. The update of the I/O status is completed automatically through the Motionnet system at a constant interval, and setting interrupts for specific input points that the customer wants to monitor can help prevent CPU time from being wasted by repetitive polling when there is nothing else for the issuing process to do. Each input port can be specified as either NPN or PNP (12~24 V), and the internal flywheel diodes of each output port can be individually connected to different sources of power (each port is comprise of 8 I/O signals).

Specifications:

Digital Input	
Input Channels	16
Input Type	Sink/Source (NPN/PNP)
On Voltage Level	+10 ~ 30 VDC
Off Voltage Level	+3 VDC max.
Input Impedance	4.7 KΩ
Isolation Voltage	3000 Vrms
Digital Output	
Output Channels	16
Output Type	Open Collector (Sink), with internal flywheel diode
Load Voltage	+30 VDC max.
Load Current	200 mA max. for each channel
Isolation Voltage	3000 Vrms
Interface	
LED Indicators	Communication state(Link, Error) Input/output state Internal 3.3 V Power Termination resistor switch
Communication Speed	Selectable 2.5, 5, 10 or 20 Mbps by DIP Switch.

Cyclic Scan Time	15.1 μs per device (20 Mbps)
Communication Connector	MN-3254: RJ-45 x 2 MN-3254T: 5-pin terminal block
I/O Connector	13-Pin pluggable Terminal block x 4
Power	
Voltage Range	24 VDC (1000 V isolated)
Power Consumption	2 W max.
Protection	Reverse voltage and overcurrent protection
Connection	7-pin removable terminal block
Mechanical	
Case	Plastic
Flammability	UL94V-0 materials
Dimensions (W x H x D)	31 mm x 140 mm x 126.6 mm
Installation	DIN-Rail mounting
Environmental	
Operating Temperature	0 ~ + 60°C
Storage Temperature	-20 ~ +80°C
Operating Humidity	10 ~ 85%; Non-condensing
Storage Humidity	5 ~ 95%; Non-condensing

Pin Assignments:

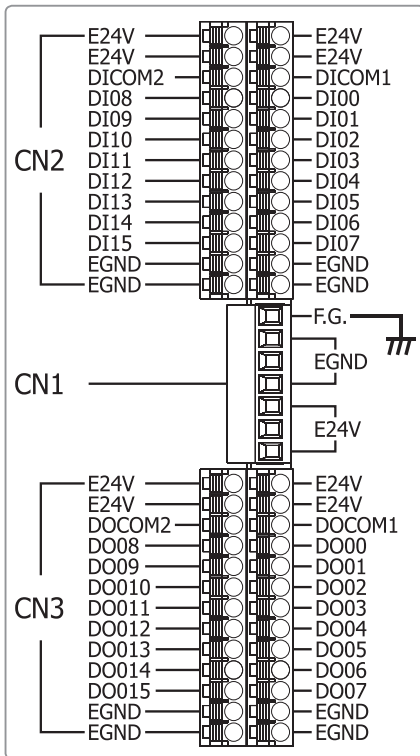

NO.	Pin Define.	Specifications	I/O Define.
CN1 Pin Assignments			
1	FG	Frame Ground	-
2 ~ 4	EGND	External Ground	Input
5 ~ 7	E24V	External 24V(+)	Input
CN2A (Right) Pin Assignments			
1 ~ 2	E24V	External 24V(+)	Connect to CN1
3	DICOM1	Common terminal of DI00~DI07	Input
4 ~ 11	DI00~DI07	Digital input channels 00~07	Input
12 ~ 13	EGND	External Ground	Connect to CN1
CN2B (Left) Pin Assignments			
1 ~ 2	E24V	External 24V(+)	Connect to CN1
3	DICOM2	Common terminal of DI08~DI15	Input
4 ~ 11	DI08~DI15	Digital input channels 08~15	Input
12 ~ 13	EGND	External Ground	Connect to CN1
CN3A (Right) Pin Assignments			
1 ~ 2	E24V	External 24V(+)	Connect to CN1
3	DOCOM1	Common Anode for Flywheel Diodes of DO00~DO07	Input
4 ~ 11	DO00~DO07	Digital output channels 00~07	Output
12 ~ 13	EGND	External Ground	Connect to CN1
CN3B (Left) Pin Assignments			
1 ~ 2	E24V	External 24V(+)	Connect to CN1
3	DOCOM2	Common Anode for Flywheel Diodes of DO08~DO15	Input
4 ~ 11	DO08~DO15	Digital output channels 08~15	Output
12 ~ 13	EGND	External Ground	Connect to CN1

Dimensions: (Units: mm)

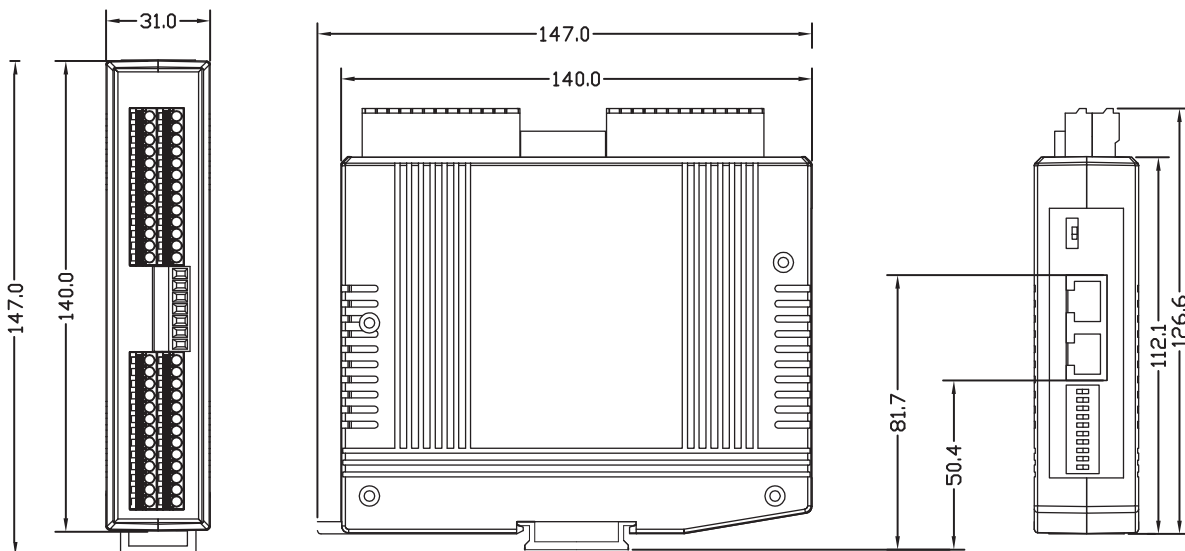

Front View

Right Side View

Top View

Ordering Information/Accessories:

Model No.	Description
MN-3254 CR	Distributed Motionnet 16-ch Isolated DI, 16-ch Isolated DO Module with RJ-45 Connector (RoHS)
MN-3254T CR	Distributed Motionnet 16-ch Isolated DI, 16-ch Isolated DO Module with Terminal Block (RoHS)
PISO-MN200 CR PISO-MN200T CR	PCI Bus, Dual-Line Motionnet Master Control Card (RoHS)
MN-SERVO CR Series MN-SERVO EC CR Series	Distributed Motionnet Single-axis Motion Control Modules (with Spring Type Terminal Blocks; EC: with e-CON Mini-Clamp Connector) (RoHS)
MN-2091U CR MN-2091U-T CR	Distributed Motionnet Single-axis Universal Motion Control Module (RoHS)

MN-3257/MN-3257T

Distributed Motionnet 32-ch Isolated DO Module



Features:

- Maximum communication speed: 20 Mbps
- 32-ch isolated digital outputs
- Each Motionnet transfer Line: connect modules up to 64
- Designing isolation protection: power, communication, I/O
- LED Diagnostics for communication and I/O status
- Each port can be specified as NPN or PNP (12~24 V)
- The internal flywheel diode of each output ports can be connect to different sources of power individually.
- High current sinking capability (200 mA)

4

2

Remote Motion Solutions

Introduction:

The **MN-3257(T)** is an I/O expansion device for Motionnet systems, and is equipped with 32 isolated digital output channels. Each Motionnet communication line can be connected to up to 64 modules, meaning that the I/O can be expanded to 2048 output channels. The communication time required by each MN-325x is 15.1 us. If 64 modules have been connected, signals for 2048 points on 64 modules can be sent and received within 0.97 msec. The update of the I/O status is completed automatically through the Motionnet system at a constant interval, and setting interrupts for specific input points that the customer wants to monitor can help prevent CPU time from being wasted by repetitive polling when there is nothing else for the issuing process to do. The internal flywheel diodes of each output port can be individually connected to different sources of power (each port is comprise of 8 I/O signals).

Specifications:

Digital Output	
Output Channels	32
Output Type	Open Collector (Sink), with internal flywheel diode
Load Voltage	+30 VDC max.
Load Current	200 mA max. for each channel
Isolation Voltage	3000 Vrms
Interface	
LED Indicators	Communication state (Link, Error) Input/output state Internal 3.3 V power Termination resistor switch
Communication Speed	Selectable 2.5, 5, 10 or 20 Mbps by DIP Switch.
Cyclic Scan Time	15.1 μs per device (20 Mbps)
Communication Connector	MN-3257: RJ-45 x 2 MN-3257T: 5-pin terminal block
I/O Connector	13-pin pluggable Terminal block x 4

Power	
Voltage Range	24 VDC (1000 V isolated)
Power Consumption	2 W max.
Protection	Reverse voltage and overcurrent protection
Connection	7-pin removable terminal block
Mechanical	
Case	Plastic
Flammability	UL94V-0 materials
Dimensions (W x H x D)	31 mm x 140 mm x 126.6 mm
Installation	DIN-Rail mounting
Environmental	
Operating Temperature	0 ~ + 60°C
Storage Temperature	-20 ~ +80°C
Operating Humidity	10 ~ 85%; Non-condensing
Storage Humidity	5 ~ 95%; Non-condensing

Pin Assignments:

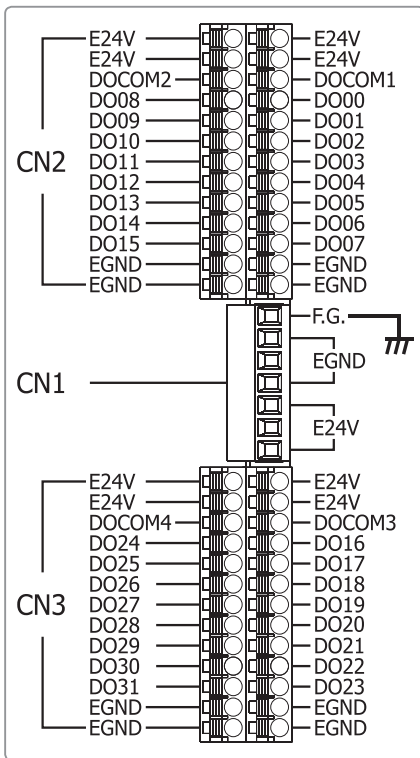

NO.	Pin Define	Specifications	I/O Define
CN1 Pin Assignments			
1	FG	Frame Ground	-
2 ~ 4	EGND	External Ground	Input
5 ~ 7	E24V	External 24V(+)	Input
CN2A (Right) Pin Assignments			
1 ~ 2	E24V	External 24V(+)	Connect to CN1
3	DOCOM1	Common Anode for Flywheel Diode of DO00~DO07	Input
4 ~ 11	DO00~DO07	Digital output channels 00~07	Output
12 ~ 13	EGND	External Ground	Connect to CN1
CN2B (Left) Pin Assignments			
1 ~ 2	E24V	External 24V(+)	Connect to CN1
3	DOCOM2	Common Anode for Flywheel Diode of DO08~DO15	Input
4 ~ 11	DO08~DO15	Digital output channels 08~15	Output
12 ~ 13	EGND	External Ground	Connect to CN1
CN3A (Right) Pin Assignments			
1 ~ 2	E24V	External 24V(+)	Connect to CN1
3	DOCOM3	Common Anode for Flywheel Diode of DO16~DO23	Input
4 ~ 11	DO16~DO23	Digital output channels 16~23	Output
12 ~ 13	EGND	External Ground	Connect to CN1
CN3B (Left) Pin Assignments			
1 ~ 2	E24V	External 24V(+)	Connect to CN1
3	DOCOM4	Common Anode for Flywheel Diode of DO24~DO31	Input
4 ~ 11	DO24~DO31	Digital output channels 24~31	Output
12 ~ 13	EGND	External Ground	Connect to CN1

Dimensions: (Units: mm)

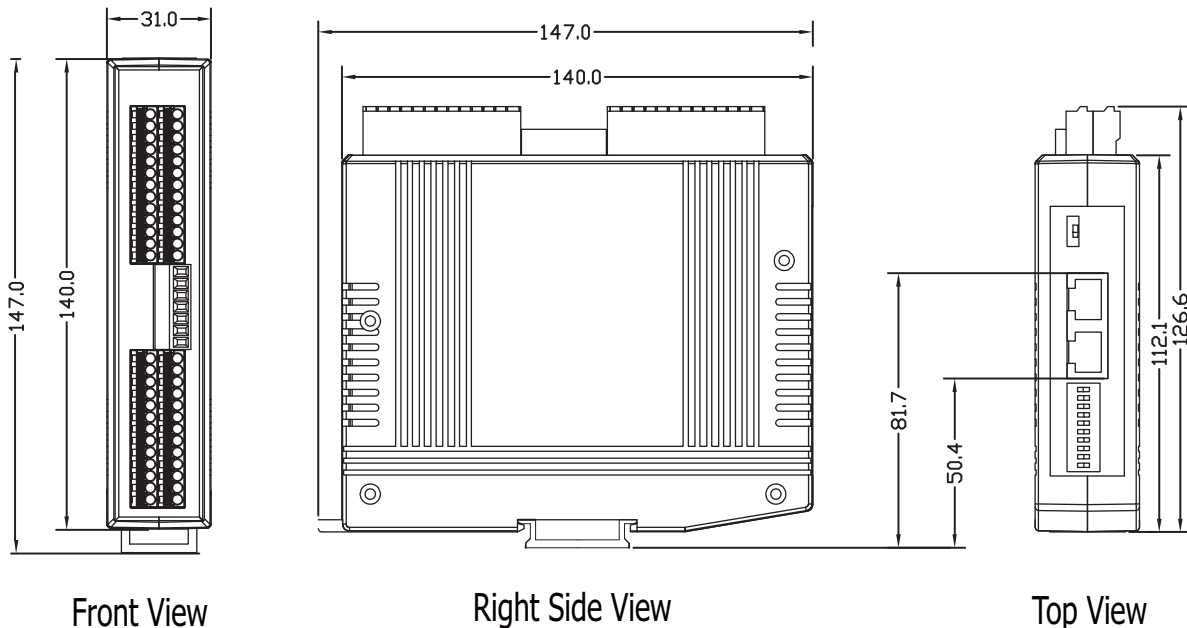

Ordering Information/Accessories:

Model No.	Description
MN-3257 CR	Distributed Motionnet 32-ch Isolated DO Module with RJ-45 Connector (RoHS)
MN-3257T CR	Distributed Motionnet 32-ch Isolated DO Module with Terminal Block (RoHS)
PISO-MN200 CR PISO-MN200T CR	PCI Bus, Dual-Line Motionnet Master Control Card (RoHS)
MN-SERVO CR Series MN-SERVO EC CR Series	Distributed Motionnet Single-axis Motion Control Modules (with Spring Type Terminal Blocks; EC: with e-CON Mini-Clamp Connector) (RoHS)
MN-2091U CR MN-2091U-T CR	Distributed Motionnet Single-axis Universal Motion Control Module (RoHS)

4.3 CANopen Motion Solutions

Introduction:

The **CAN (Controller Area Network) bus** is one of the safest industrial network systems, and CANopen is the standard industrial communication protocol on the CAN bus. CANopen technology has been used in a wide range of application fields, including medical equipment, vehicles, railway applications or building automation. ICP DAS provides a motion control library (CiA 402) for CANopen Master products meaning that users can now integrate motion control systems into a CANopen network, providing the ability to control CANopen-based motors and remote I/O devices within the same network, making wire connections and control easier and more efficient.

The CANopen Motion Library is compliant with the CANopen standard CiA 402, and provides a variety of motion control functions, such as position control, velocity control, torque control, synchronous action etc. The CiA 402 is one of the standard CANopen application profiles, and is specially designed for motion control systems. In addition to making the management of the CANopen-based motors easy, the CANopen protocol, which is based on the CAN bus, can help to reduce the need for wire connections between the controller and the motors, and provides rapid troubleshooting functions. A large number of CANopen-based motors can be linked together so that multi-axis motion control via a single host becomes achievable. While controlling the motors, CANopen-based remote I/O modules that comply with the CiA 402 standard can also be accessed at the same time. Therefore, developing a motion control application becomes easier and more convenient.

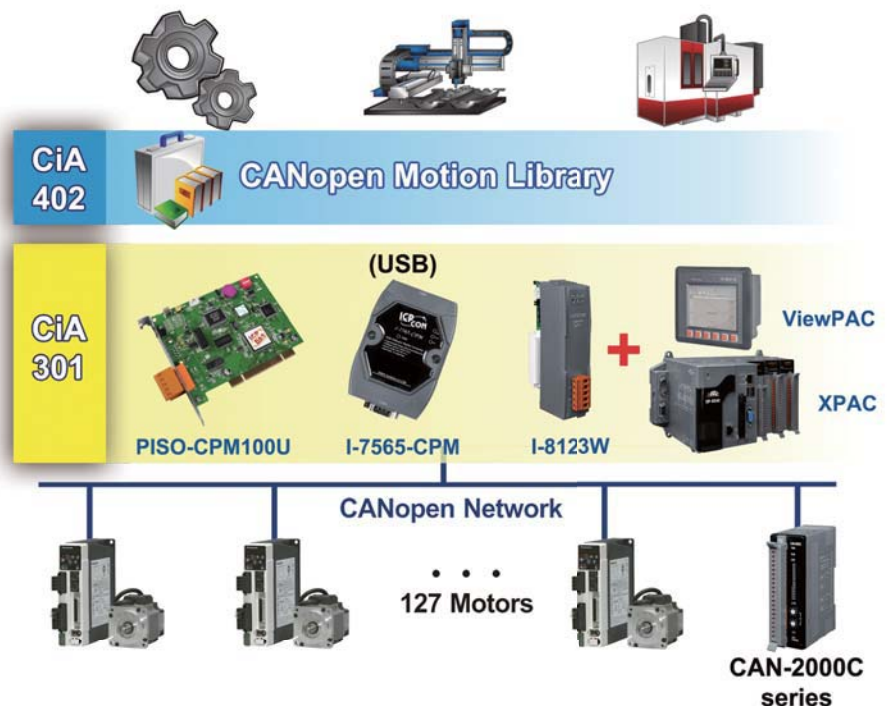

Features:

- Compliant with the CiA 402 v1.1 Standard
- Supports a max. of 127 motors in a single network
- Absolute and relative position control
- Velocity, torque or jog control
- Supports synchronous action for a maximum of 127 motors
- Supports various homing control methods
- Supports torque limitation via CANopen commands
- Supports the node guarding and heartbeat protocols
- Supports dynamic PDO object configuration
- Bus distance ranges between 25 m to 5000 m
- Supports baud rates of 10 Kbps, 20 Kbps, 50 Kbps, 125 Kbps, 250 Kbps, 500 Kbps, 800 Kbps and 1 Mbps.

Benefits:

- Suitable for distributed multi-axis motion control systems. E.g., distributed sun tracker systems, conveyer transmission control systems, and so on.
- Reduces the cost of wiring, especially time requirements.
- Choose from a range of motors with no limit on certain types.
- The CAN hardware has a range of error detection and error correction mechanisms, which provides the safest communication bus.
- Able to use different CANopen I/O modules and motors in the same CANopen network.
- The range of the CANopen bus can be extended for long distance applications. For example, for solar or wind farm application systems.
- The CANopen bus can be converted to fiber to protect against high noise interference.

Typical Application Network:

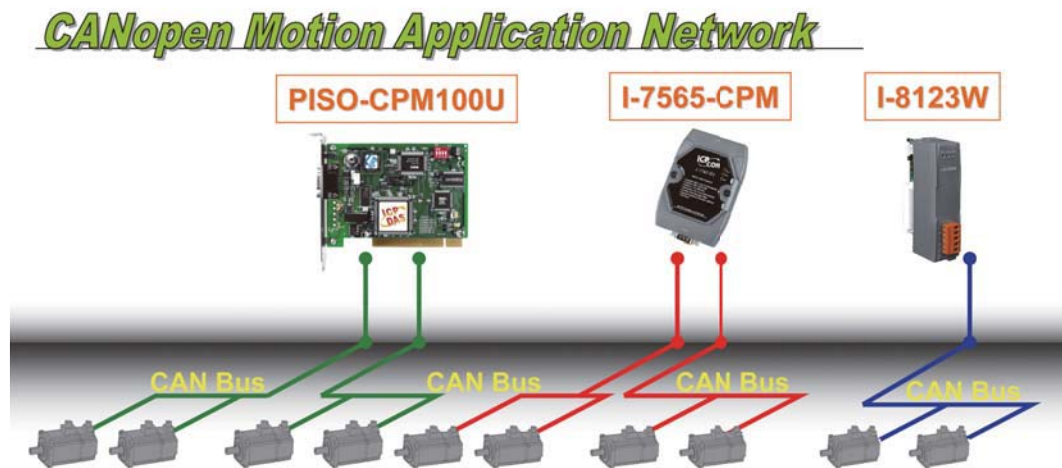

CANopen Motion Applications:

1. Corrugated Carton Cutting Machine

A creasing and cutting machine is one kind of equipment for creasing and cutting ordinary cardboard corrugated board plastic and leather in general, applicable to printing packaging decoration and plastic industries. Machine is characterized by compact structure, fine workmanship, big pressure, and high precision and easy and reliable operation. With high degree of automation, this model can do integrative process of auto-feeding, cutting and auto-unloading. All the cutting knives and rollers are controlled by 31 CANopen motors. The WP-8441 and I-8123W play the role of the CANopen master to control all the motors simultaneously.

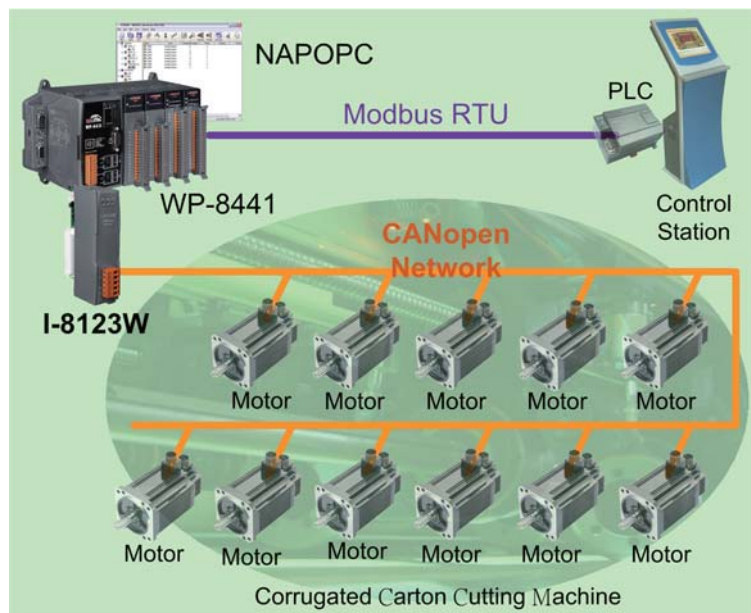

2. Solar Tracking System

Solar Tracking System is a distribute device for orienting a solar panel or concentrating a solar reflector or lens towards the sun. The sun's position in the sky varies both with the seasons and time of day as the sun moves across the sky. The solar energy intercepted by the solar panels during the course of the day is not maximized if the position of the panel is always static. Dynamically oriented solar panels can track the sun throughout each day to greatly enhance energy collection. There are more than 100 motors in that system. The tracker built-in one or two axis motors. The PC and PISO-CPM100 control parts of the solar panels.

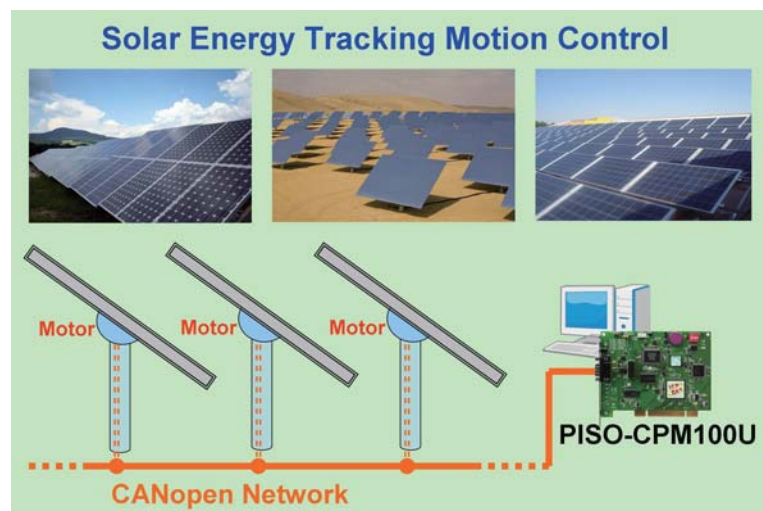

CANopen Master Cards:

PISO-CPM100U



PCI Board for Industrial PC

Features:

- Universal PCI supports both the 5 V and 3.3 V PCI bus
- Embedded 80186, 80 MHz CPU
- Baud Rate: 10, 20, 50, 125, 250, 500 and 800 Kbps, and 1 Mbps
- Comply with the CANopen CiA 301 and CiA 402 profiles
- Support the Guarding and Heartbeat protocol
- Support EMCY receiving
- Provide dynamic PDO functions
- Support Windows 2000/XP, Win 7 (32-bit)
- Libraries for BCB6, VC6, VB6, C#, etc.

Introduction:

The **PISO-CPM100** is a PCI board for industrial applications compliant with the CiA CANopen specification CiA 301 and CiA 402. The embedded 80186 80M Hz CPU means that the card is highly suitable for high transmission applications, and the 16-bit on-board micro-controller with the real-time MiniOS7 Operating System provides many features, such as real-time message transmission and reception, filtering, preprocessing, and storage of CAN messages. Times tamping of PDO messages with at least 1 ms precision is also supported. Combined with the free CPM Utility, users can easily manage and integrate a range of CANopen industrial devices.

Specifications:

Hardware	
CPU	80186, 80 MHz or compatible
SRAM / Flash / EEPROM	512 KB / 512 KB / 2 KB
Bus Interface	
Type	PCI bus, 5 V, 33 MHz, 32-bit, plug and play.
Board No.	Via DIP switch
CAN Interface	
Controller	NXP SJA1000T with 16 MHz clock
Transceiver	NXP 82C250
Channel Number	1
Connectors	PISO-CPM100-D: 9-pin male D-Sub (CAN_L, CAN_SHLD, CAN_H, N/A for others) PISO-CPM100-T: 5-pin screwed terminal block (CAN_L, CAN_SHLD, CAN_H, N/A for others)
Baud Rate (bps)	10, 20, 50, 125, 250, 500, 800 Kbps, and 1 Mbps
Transmission Distance (m)	Depend on baud rate (for example, max. 1000 M at 50 Kbps)
Isolation	1000 VDC for DC-to-DC, 2500 Vrms for photocouples
Terminator Resistor	Jumper for 120 Ω terminator resistor
Specifications	ISO-11898-2, CAN 2.0A and CAN 2.0B
Protocols	CANopen CiA 301 v4.02, CiA 402 v1.1

LED	
Round LED	Green, Red
Software	
Driver	Windows 2000/XP, Win 7 (32-bit)
Library	VB 6.0, VC++ 6.0, BCB 6.0.
Power	
Power Supply	Unregulated +10 ~ +30 VDC
Power Consumption	300 mA @ 5 V
Mechanical	
Dimensions	127 mm x 121 mm (W x H)
Environmental	
Operating Temperature	0 ~ 60°C
Storage Temperature	-20 ~ 80°C
Humidity	0 ~ 95% RH, non-condensing

Pin Assignments:

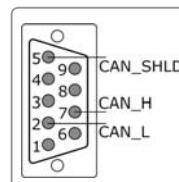

9-pin
D-Sub
Male
Connector

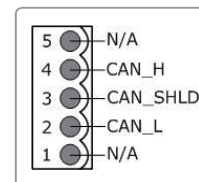

5-pin
Screw
Terminal
Connector

Ordering Information:

Model No.	Description
PISO-CPM100-D	1 Port Intelligent CANopen Master Universal PCI Board with D-Sub 9-pin male connector
PISO-CPM100-T	1 Port Intelligent CANopen Master Universal PCI Board with 5-pin screw terminal connector
CAN-8x23 Series	CANopen Remote I/O Expansion Unit with 1/2/4/8 slots
CAN-2000C Series	Distributed CANopen I/O Modules

CANopen Converter:

I-7565-CPM



USB to CANopen Master Converter

Features:

- Fully compliant with USB 1.1/2.0 specifications
- Built-in 80186, 80 MHz CPU
- Powered via USB
- Baud Rate: 10, 20, 50, 125, 250, 500 and 800 Kbps, and 1 Mbps
- Compliant with the CANopen CiA 301 and CiA 402 profiles
- Support for the Guarding and Heartbeat protocols
- Support EMCY receiving
- Provide dynamic PDO functions
- Support Windows 2000/XP, Win 7 (32-bit)
- Libraries for BCB6, VC6, VB6 and C#, etc.

Introduction:

The **I-7565-CPM** was developed as a standardized CANopen network device with highly flexible configuration capabilities, and is a CANopen master solution with a USB interface and an 80 MHz 186 CPU. The module complies with the CANopen CiA 301 and CiA 402. There is a CANopen protocol interpreter, I-7565-CPM firmware, running in the I-7565-CPM. This converter can be used to process the complex CANopen protocol without dramatically increasing the PC load. The rich APIs provided by the I-7565-CPM library together with the easy-to-use utility tool can satisfy the requirements of a wide range of complex CANopen applications.

Specifications:

Hardware	
CPU	80186, 80 MHz.
SRAM/Flash/EEPROM	512 KB / 512 KB / 16 KB
ESD Protection	2 kV class A and 3 kV class B
CAN Interface	
Controller	NXP SJA1000T CAN Controller
Transceiver	NXP 82C250 CAN Transceiver
Interface	ISO/IS 11898-2, 9-pin male D-Sub (GAN_GND, CAN_L, CAN_SHLD, CAN_H, CAN_V+, N/A for others)
Transfer Rate	10, 20, 50, 125, 250, 500, 800 Kbps, and 1 Mbps
Specifications	CANopen CiA 301 v4.02, CiA 402 v1.1
USB Interface	
Connector	USB Type B
Transmission Speed	921.6 Kbps
LED	
Round LED	PWR, ACT, ERR, Tx/Rx

Software	
Driver	Windows 2000/XP, Win 7 (32-bit)
Library	VC++6.0, VB6, C#.net, VB.net
Power	
Power Supply	Via USB interface.
Mechanical	
Dimensions	72 mm x 101 mm x 33 mm (W x L x H)
Environmental	
Operating Temperature	-25 ~ +75°C
Storage Temperature	-30 ~ +80°C
Humidity	10 ~ 90% RH, non-condensing

Pin Assignments:

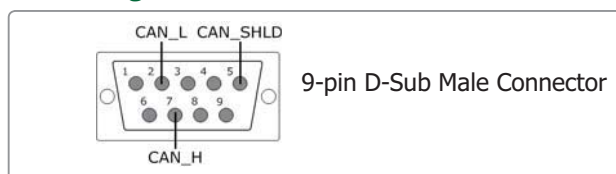

Ordering Information:

Model No.	Description
I-7565-CPM	USB to CANopen Master Converter
CAN-8x23 Series	CANopen Remote I/O Expansion Unit with 1/2/4/8 slots
CAN-2000C Series	Distributed CANopen I/O Modules

CANopen Master Module:

I-8123W

High Performance Intelligent CANopen Master Module (For WinPAC/ViewPAC/XPAC)

Features:

- Supports WinPAC/ViewPAC/XPAC series PAC controllers
- Embedded 80186, 80 MHz CPU
- Baud Rate: 10, 20, 50, 125, 250, 500 and 800 Kbps, and 1 Mbps
- Complies with CANopen CiA 301 and CiA 402 profiles
- Supports Guarding and Heartbeat protocols
- Supports EMCY receiving
- Provides dynamic PDO functions
- Supports WinCE 5/6, XPe OS
- Libraries provided for BCB6, VC6, VB6 and C#, etc.

Introduction:

The **I-8123W** is a high-performance/low-cost CANopen Master module that is compliant with CiA CANopen specification CiA 301 and CiA 402. Thanks to the ViewPAC or WinPAC series MCU (main control unit), the module can be generally applied to industrial automation, building automation, vehicle, and embedded control networks. In addition the embedded CANopen protocol firmware means that users can easily access slave devices via the I-8123W without requiring in-depth knowledge of the complex CANopen protocol, which is helpful in reducing the development cycle time and allows users to establish their CANopen applications more quickly and easily.

Specifications:

Hardware	
CPU	80186, 80 MHz or compatible
SRAM/Flash/EEPROM	512 KB / 512 KB / 16 KB
Watchdog	Yes
CAN Interface	
Controller	NXP SJA1000T with 16 MHz clock
Transceiver	NXP 82C250
Channel Number	1
Connector	5-pin screwed terminal block (CAN_GND, CAN_L, CAN_H, N/A for others)
Baud Rate (bps)	10, 20, 50, 125, 250, 500, 800 Kbps, 1 Mbps
Transmission Distance (m)	Depends on baud rate (for example, max. 1000 M at 50 Kbps)
Isolation	3000 V _{DC} for DC-to-DC, 2500 V _{rms} for photocouples
Terminator Resistor	Switch for 120 Ω terminator resistor
Specifications	ISO-11898-2, CAN 2.0A and CAN 2.0B
Protocols	CANopen CiA 301 v4.02, CiA 402 v1.1

LED	
Round LED	PWR, RUN, ERR
Software	
Driver	Windows CE 5.0 / 6.0
Library	eVC++4.0, VB.Net 2005, C#.Net 2005
Power	
Power Consumption	2 W
Mechanical	
Dimensions	31 mm x 91 mm x 115 mm (W x L x H)
Environmental	
Operating Temp.	-25 ~ +75°C
Storage Temp.	-30 ~ +80°C
Humidity	10 ~ 90% RH, non-condensing

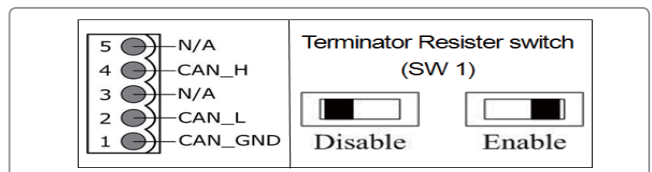
CAN Pin & Terminator Resistor Switch:

Ordering Information:

Model No.	Description
I-8123W-G	1 Port High Performance Intelligent CANopen Master Module
CAN-8x23 Series	CANopen Remote I/O Expansion Unit with 1/2/4/8 slots
CAN-2000C Series	Distributed CANopen I/O Modules

Accessories



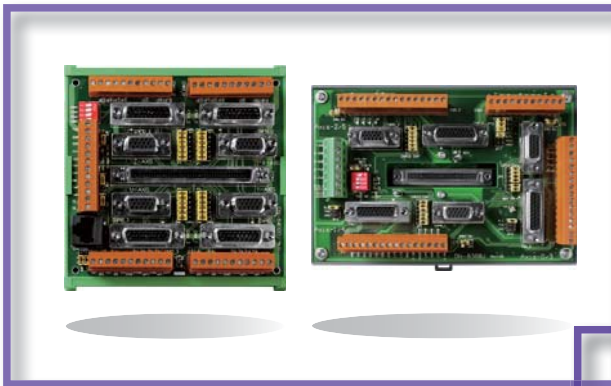

5. Accessories

5.1 Terminal Boards	5-1-1
5.2 FRnet Remote I/O Modules	5-2-1
5.3 Cables and Connectors	5-3-1



5. Accessories

5.1 Terminal Boards

<p>DB-8R Relay Board for SERVO-300U and PISO-PS300</p>  <ul style="list-style-type: none"> • I/O connector block with Din-rail mounting • Connection board for PISO-PS300 or SERVO-300U • For Limit Switches, Digital Inputs/Outputs • 25-pin D-Sub connector • Pin-to-Pin screw terminal for I/O connections • Screw terminals for easy field wiring 	<p>DB-200 Encoder Input Board for SERVO-300</p>  <ul style="list-style-type: none"> • I/O connector block with Din-rail mounting • Connection board for SERVO-300 Driver • 25-pin D-Sub connector and two 9-pin D-Sub connectors • Pin-to-Pin screw terminal for I/O connections • Screw terminals for easy field wiring
---	--

<p>DN-68 Encoder Input Board for PISO-ENCODER300U and PISO-ENCODER600U (RoHS)</p>  <ul style="list-style-type: none"> • I/O connector block with Din-rail mounting • 68-pin SCSI-II connector • Pin-to-Pin screw terminal for I/O connections • Screw terminals for easy field wiring • Dimensions: 103 mm x 86 mm 	
---	--

<p>DN-20M Manual-Pulse-Generator (MPG) and FRnet Input Board for PISO-PS600/VS600/PMDK (RoHS)</p>  <ul style="list-style-type: none"> • MPG and FRnet connector block with Din-rail mounting. • 20-pin SCSI-II connector • Pin-to-Pin screw terminal for manual pulse generator connection • Screw terminals for easy field wiring • RJ-45 for FRnet connector 	<p>Specifications:</p> <table border="1"> <tr> <th colspan="2">Power</th> </tr> <tr> <td>Nominal Load</td> <td>0.1 A / 24 VDC</td> </tr> <tr> <td>Input Power</td> <td>20 ~ 26 V_{DC}, 0.1 A</td> </tr> <tr> <td>Power Consumption</td> <td>2.4 W (24 VDC)</td> </tr> <tr> <th colspan="2">Environmental</th> </tr> <tr> <td>Operating Temperature</td> <td>-20 ~ +75°C</td> </tr> <tr> <td>Storage Temperature</td> <td>-30 ~ +85°C</td> </tr> <tr> <td>Operating Humidity</td> <td>20 ~ 80% RH, Non-condensing</td> </tr> <tr> <td>Storage Humidity</td> <td>10 ~ 90% RH, Non-condensing</td> </tr> <tr> <th colspan="2">Mechanical</th> </tr> <tr> <td>Dimensions</td> <td>103 mm X 86 mm</td> </tr> </table>	Power		Nominal Load	0.1 A / 24 VDC	Input Power	20 ~ 26 V _{DC} , 0.1 A	Power Consumption	2.4 W (24 VDC)	Environmental		Operating Temperature	-20 ~ +75°C	Storage Temperature	-30 ~ +85°C	Operating Humidity	20 ~ 80% RH, Non-condensing	Storage Humidity	10 ~ 90% RH, Non-condensing	Mechanical		Dimensions	103 mm X 86 mm
Power																							
Nominal Load	0.1 A / 24 VDC																						
Input Power	20 ~ 26 V _{DC} , 0.1 A																						
Power Consumption	2.4 W (24 VDC)																						
Environmental																							
Operating Temperature	-20 ~ +75°C																						
Storage Temperature	-30 ~ +85°C																						
Operating Humidity	20 ~ 80% RH, Non-condensing																						
Storage Humidity	10 ~ 90% RH, Non-condensing																						
Mechanical																							
Dimensions	103 mm X 86 mm																						

DN-8237 Series: Photo-isolated Terminal Boards for ICP DAS 2-axis Stepper/Servo Motion Controllers	
DN-8237UB	Universal Snap-on Wiring Terminal Board
DN-8237GB	General Purpose Wiring Terminal Board
DN-8237MB	Snap-on Wiring Terminal Board for Mitsubishi MELSERVO-J2 Servo Amplifier
DN-8237PB	Snap-on Wiring Terminal Board for Panasonic MINAS A4/A5 Servo Amplifier
DN-8237YB	Snap-on Wiring Terminal Board for Yaskawa Sigma II/III/V Servo Amplifier
DN-8237DB	Snap-on Wiring Terminal Board for Delta ASDA-A Servo Amplifier

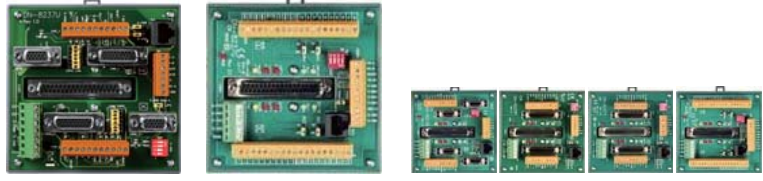
 <p>DN-8237UB DN-8237GB DN-8237MB DN-8237PB DN-8237YB DN-8237DB</p> <p>Features:</p> <ul style="list-style-type: none"> • High-speed Photocouple isolation • Support Pulse Command Type Step Motors or Servo Motors • Include a Power LED and other status LEDs (Home, Limit Switches, etc.) • Include an FRnet Terminal for High-speed serial I/O expansion when the controller supports FRnet 	<p>Specifications:</p> <table border="1"> <tr> <th colspan="2">Power</th> </tr> <tr> <td>Nominal Load</td> <td>0.5 A / 24 VDC</td> </tr> <tr> <td>Input Power</td> <td>20 ~ 26 V_{DC}, 0.5 A</td> </tr> <tr> <td>Power Consumption</td> <td>12 W (24 VDC)</td> </tr> <tr> <th colspan="2">Environmental</th> </tr> <tr> <td>Operating Temperature</td> <td>-20 ~ +75°C</td> </tr> <tr> <td>Storage Temperature</td> <td>-30 ~ +85°C</td> </tr> <tr> <td>Operating Humidity</td> <td>20 ~ 80% RH, Non-condensing</td> </tr> <tr> <td>Storage Humidity</td> <td>10 ~ 90% RH, Non-condensing</td> </tr> <tr> <th colspan="2">Mechanical</th> </tr> <tr> <td>Dimensions</td> <td>110 mm X 107 mm</td> </tr> </table>	Power		Nominal Load	0.5 A / 24 VDC	Input Power	20 ~ 26 V _{DC} , 0.5 A	Power Consumption	12 W (24 VDC)	Environmental		Operating Temperature	-20 ~ +75°C	Storage Temperature	-30 ~ +85°C	Operating Humidity	20 ~ 80% RH, Non-condensing	Storage Humidity	10 ~ 90% RH, Non-condensing	Mechanical		Dimensions	110 mm X 107 mm
Power																							
Nominal Load	0.5 A / 24 VDC																						
Input Power	20 ~ 26 V _{DC} , 0.5 A																						
Power Consumption	12 W (24 VDC)																						
Environmental																							
Operating Temperature	-20 ~ +75°C																						
Storage Temperature	-30 ~ +85°C																						
Operating Humidity	20 ~ 80% RH, Non-condensing																						
Storage Humidity	10 ~ 90% RH, Non-condensing																						
Mechanical																							
Dimensions	110 mm X 107 mm																						

DN-8368 Series: Photo-isolated Terminal Board for PISO-PS600/V5600/PMDK

DN-8368UB	Universal Snap-on Wiring Terminal Board
DN-8368GB	General Purpose Wiring Terminal Board
DN-8368MB	Snap-on Wiring Terminal Board for Mitsubishi MELSERVO-J2 Servo Amplifier

**DN-8368UB****DN-8368GB****DN-8368MB****Features:**

- High-speed Photocouple isolation
- Support Pulse/Voltage Command Type Step Motors or Servo Motors
- Include a Power LED and other status LEDs (Home, Limit Switches, etc.)

Specifications:

Power	
Nominal Load	0.5 A / 24 V _{DC}
Input Power	20 ~ 26 V _{DC} , 0.5 A
Power Consumption	12 W (24 V _{DC})
Environmental	
Operating Temperature	-25 ~ +75°C
Storage Temperature	-30 ~ +85°C
Operating Humidity	20 ~ 80% RH, Non-condensing
Storage Humidity	10 ~ 90% RH, Non-condensing
Mechanical	
Dimensions	162 mm X 107 mm

DN-8468 Series: Photo-isolated Terminal Boards for ICP DAS 4-axis Stepper/Servo Motion Controllers

DN-8468UB	Universal Snap-on Wiring Terminal Board
DN-8468GB	General Purpose Wiring Terminal Board
DN-8468MB	Snap-on Wiring Terminal Board for Mitsubishi MELSERVO-J2 Servo Amplifier
DN-8468PB	Snap-on Wiring Terminal Board for Panasonic MINAS A4/A5 Servo Amplifier
DN-8468YB	Snap-on Wiring Terminal Board for Yaskawa Sigma II/III/V Servo Amplifier
DN-8468DB	Snap-on Wiring Terminal Board for Delta ASDA-A Servo Amplifier
DN-8468FB	Snap-on Wiring Terminal Board for Fuji FALDIC-W Servo Amplifier

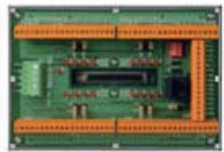
**DN-8468UB****DN-8468GB****DN-8468MB****DN-8468PB****DN-8468YB****DN-8468DB****DN-8468FB****Features:**

- High-speed Photocouple isolation
- Support Pulse Command Type Step Motors or Servo Motors
- Include a Power LED and other status LEDs (Home, Limit Switches, etc.)
- Include an FRnet Terminal for High-speed serial I/O expansion when the controller supports FRnet

Specifications:

Power	
Nominal Load	0.5 A / 24 V _{DC}
Input Power	20 ~ 26 V _{DC} , 0.5 A
Power Consumption	12 W (24 V _{DC})
Environmental	
Operating Temperature	-20 ~ +75°C
Storage Temperature	-30 ~ +85°C
Operating Humidity	20 ~ 80% RH, Non-condensing
Storage Humidity	10 ~ 90% RH, Non-condensing
Mechanical	
Dimensions	162 mm X 107 mm

DN-84100U Universal Snap-on Wiring Terminal Board for PISO-PS410 and PISO-PS810**Features:**

- Support Pulse Command Type Step Motors or Servo Motors
- Include a Power LED and other status LEDs (Home, Limit Switches, etc.)
- Include an FRnet Terminal for High-speed serial I/O expansion when the controller supports FRnet

Specifications:

Power	
Nominal Load	0.5 A / 24 V _{DC}
Input Power	20 ~ 26 V _{DC} , 0.5 A
Power Consumption	12 W (24 V _{DC})
Environmental	
Operating Temperature	-25 ~ +75°C
Storage Temperature	-30 ~ +85°C
Operating Humidity	20 ~ 80% RH, Non-condensing
Storage Humidity	10 ~ 90% RH, Non-condensing
Mechanical	
Dimensions	118 mm X 121 mm

5.2 FRnet Remote I/O Modules

High-speed Synchronization Remote I/O Control

Introduction

FRnet is an innovative industrial field bus. It uses twisted pair cable as the transmission medium. Each FRnet port can link up to 128 DI and 128 DO channels. The whole I/O status are updated at a fixed cycle time (0.72 ms or 2.88 ms) no matter how many FRnet I/O modules are connected to the FRnet network. Furthermore, the update is done by the FRnet chip, there is no need for a communication protocol. Using FRnet, the user can easily and quickly implement high-speed distributed I/O control systems.

FRnet Specification	Normal speed	High-speed
Communication Speed	250 Kbps	1 Mbps
Cycle Time	2.88 ms	0.72 ms
Communication Distance	Max. 400 M	Max. 100 M
I/O Channels	128 DI / 128 DO	128 DI / 128 DO

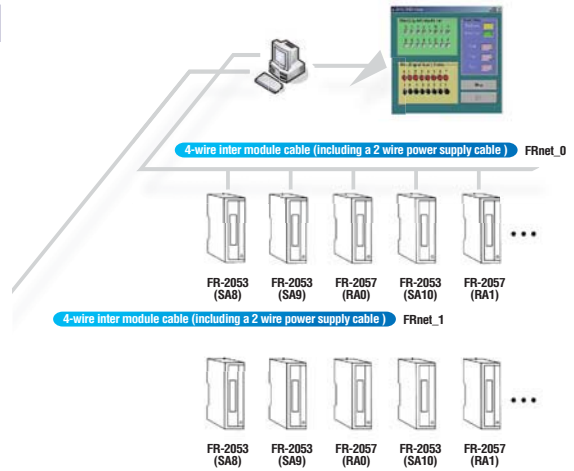

Applications

Building Automation, Machine Automation, Testing Equipment, etc.

Features

1. Token-stream Communication

The FRnet chip uses a simple token-stream communication mechanism to provide a fast and fixed cycle time I/O-scanning capability. It doesn't need any special transmission protocol; the chip takes care of the data transfer for every device.

The most significant benefits of FRnet are:

- **Fixed cycle time:**

The cycle time is fixed at 2.88/0.72 ms no matter how many devices connected in the network.

- **Memory-Mapped I/O:**

The data transfer is automatically done by the FRnet chip. The CPU of the host (PC or PAC) doesn't need to take care of the communication protocol. All I/O status are mapped to the memory of the FRnet chip.

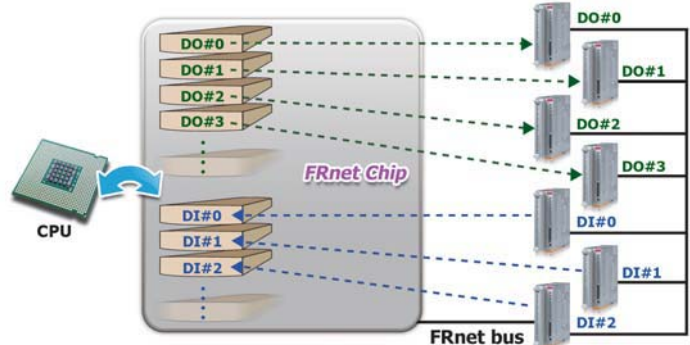

2. Multi-drop Networking

The physical connection is same as the standard RS-485 cabling to implement multi-drop networking. The maximum communication distance is up to 100/400 m at high/normal speed communication.



- **I/O expansion up to 128 DI and 128 DO channels**

Each FRnet chip addresses 8 DI and 8 DO groups which each group contains 16 DI or DO channels

- **DO broadcasting**

Due to the broadcasting algorithm adopted, the DO group address is not required to be unique. Therefore, it is easy to build a data delivery from one group (16-bit data) to a multi-group.

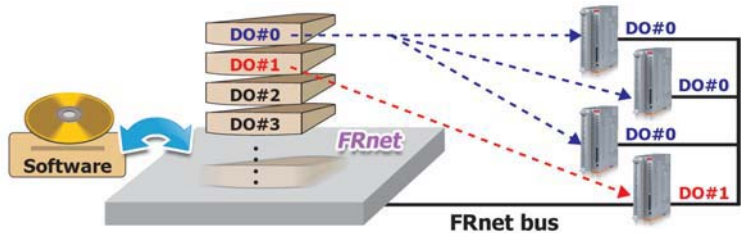

3. Easy to Diagnose

There are several LED indicators to diagnose whether FRnet I/O modules work properly. And the built-in FRnet terminator switch can be used to improve communication signal quality.

4. Easy to Configure

All basic configurations (address, speed and input/output range of AI/AO modules) are set by DIP switches. The operator can use only one screwdriver to complete the configuration.

FRnet Remote I/O Modules - Selection Guide

Features of FRnet Remote I/O Modules:

- Built-in wire-saving FRnet DI/DO control
- High-speed transmission reliability
- Simple synchronization mechanism
- No software overhead on protocol processing
- Supporting broadcasting (1:n data transmission)
- Easy output duplication
- Fixed I/O scan-time and I/O synchronization
- DIN-Rail mountable

	FR-2053 Series (16-ch Isolated DI Module)	
	FR-2053iT	16-ch Sink/Source Type Isolated Digital Input Module (with Isolated Communication Line)
	FR-2053HTA FR-2053TA	16-ch Sink/Source Type Isolated Digital Input Module (H is for high-speed)
	FR-2053HT FR-2053T	16-ch Sink Type Isolated Digital Input Module (H is for high-speed)
	FR-2046 Series (16-ch Isolated DI Module)	
	FR-2046iT	16-ch Dry Contact Isolated Digital Input Module (with Isolated Communication Line)
	FR-2057 Series (16-ch Isolated DO Module)	
	FR-2057iT	16-ch Sink Type Isolated Digital Output Module (with Isolated Communication Line)
	FR-2057HTA FR-2057TA	16-ch Source Type Isolated Digital Output Module (H is for high-speed)
	FR-2057HT FR-2057T	16-ch Sink Type Isolated Digital Output Module (H is for high-speed)
	FR-2057TW	16-ch Sink Type Isolated High Current Digital Output Module
	FR-2054 Series (8-ch DO and 8-ch DI Module)	
	FR-2054T	8-ch Digital Output and 8-ch Digital Input Module
	FR-2152 Series (8-ch Isolated DI Module)	
	FR-2152T	8-ch Isolated Digital Input Module (with 12-pin Screw Terminal Connector)
	FR-2156 Series (8-ch Isolated DO Module)	
	FR-2156T	8-ch Isolated Digital Output Module (with 12-pin Screw Terminal Connector)
	FR-2017 Series (8/16-ch Isolated AI Module)	
	FR-2017iT	8/16-ch Isolated Analog Input Module (With High Voltage Protection & Isolated Communication Line)
	FR-2024 Series (4-ch Isolated AO Module)	
	FR-2024iT	4-ch Isolated Analog Output Module (with Isolated Communication Line)
	FR-32iP Series (32-ch Isolated DI Module)	
	FR-32iP/DIN	32-ch Sink/Source Type Isolated Digital Input Module (with Isolated Communication Line)
	FR-32iR Series (32-ch Isolated DO Module)	
	FR-32iR/DIN	32-ch Relay Type Isolated Digital Output Module (with Isolated Communication Line)

5.3 Cables and Connectors

For Motion Card/Module:

CA-3715DM-H CA-3730DM-H CA-3750DM-H		CA-SCSI15-H CA-SCSI30-H CA-SCSI50-H		CA-SCSI15-H CA-SCSI30-H CA-SCSI50	
	DB-37 D-Sub Male-Male Cable for High-speed Motion Applications, 1.5/3/5 M.		68-pin SCSI-II and 68-pin Male Connector Cable for High-speed Motion Applications, 1.5/3/5 M.		68-pin SCSI-II and 68-pin Male Connector Cable, 1.5/3/5 M. (for PISO-ENCODER600/600U/300/300U)
CA-SCSI100-15		CA-MINI100-15		CA-MINI68-15	
	SCSI-II 100-pin & 100-pin Male Connector Cable, 1.5 M.		100-pin VHDCI to SCSI-II Connector Cable, 1.5 M.		68-pin VHDCI to SCSI-II Connector Cable, Length 1.5 M

For Universal Snap-on Wiring Terminal Board:

CA-26-MJ3-15 CA-26-MJ3-30 CA-26-MJ3-50		CA-26-PA4-15 CA-26-PA4-30 CA-26-PA4-50		CA-26-YSV-15 CA-26-YSV-30 CA-26-YSV-50	
	26-pin HD D-Sub Male Cable for Mitsubishi Servo Amplifier, 1.5/3/5 M. (for MELSERVO-J3/J4 Series)		26-pin HD D-Sub Male Cable for Panasonic Servo Amplifier, 1.5/3/5 M. (for MINAS A4/A5 Series)		26-pin HD D-Sub Male Cable for Yaskawa Servo Amplifier, 1.5/3/5 M. (for Sigma II/III/V Series)
CA-26-TTA-15 CA-26-TTA-30 CA-26-TTA-50		CA-26-DAA2-15 CA-26-DAA2-30 CA-26-DAA2-50		CA-26-DAB2-15 CA-26-DAB2-30 CA-26-DAB2-50	
	26-pin HD D-Sub Male Cable for Teco Servo Amplifier, 1.5/3/5 M. (for TSTA-A/A+ Series)		26-pin HD D-Sub Male Cable for Delta A2 Servo Amplifier, 1.5/3/5 M. (for ASDA-A2 Series)		26-pin HD D-Sub Male Cable for Delta B2 Servo Amplifier, 1.5/3/5 M. (for ASDA-B2 Series)
CA-26-FFW-15 CA-26-FFW-30 CA-26-FFW-50					
	26-pin HD D-Sub Male Cable for Fuji Servo Amplifier, 1.5/3/5 M. (for FALDIC-W and ALPHA5 Smart Series)				

For Snap-on Wiring Terminal Board:

CA-SCSI20-M1 CA-SCSI20-M3 CA-SCSI20-M5		CA-SCSI50-D1 CA-SCSI50-D3 CA-SCSI50-D5		CA-SCSI50-PY1 CA-SCSI50-PY3 CA-SCSI50-PY5	
	20-pin SCSI-II and 20-pin Male Connector Cable, 1/3/5 M. (for Mitsubishi J2 Series Motor)		50-pin SCSI-II and 50-pin Male Connector Cable, 1/3/5 M. (for Delta ASDA A Series Motor)		50-pin SCSI-II and 50-pin Male Connector Cable, 1/3/5 M. (for Panasonic & Yaskawa Series Motor)

For Motionnet Module:

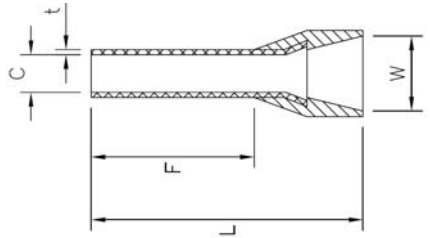

CA-PC26M		4POPP-003F		4POPP-003G	
	26-pin HD D-Sub Solder Cup Male Connector With Plastic Cover		Pink Cord-End Terminal		Turquoise Cord-End Terminal

	4POPP-003F 4POPP-003G					
	F	L	C	W	t	Wire Range (mm ²)
	8.0	12.0	0.80	1.90	0.15	0.34

4PKD10000001		4PKD10000002		4PKD10000003	
	Gray Mini Clamp Wiremount Plug		Red Mini Clamp Wiremount Plug		Orange Mini Clamp Wiremount Plug

Mini Clamp Wiremount Plug			Applicable Wire		
ICP DAS Part No.	Cover Color	3M Part No.	AWG No.	Cross-sectional Area (mm ²)	Finished External Diameter Φ (mm)
4PKD10000001	Gray	37103-2206-000FL	20 – 22	0.3 – 0.5	1.6 – 2.0
4PKD10000002	Red	37103-3101-000FL	24 – 26	0.14 – 0.3	0.8 – 1.0
4PKD10000003	Orange	37103-3163-000FL	24 – 26	0.14 – 0.3	1.2 – 1.6

For CAN Card/Module:

CNT-CAN		CA-0910-C	
	CAN bus Connector		9-pin Female D-Sub and 3-wire CAN bus cable, 1M. (Pin Assignment)



ICP DAS CO., LTD.

Local Distributor

AGS-TECH Inc

Phone: +1-505-550-6501 and +1-505-565-5102

Fax: +1-505-814-5778

Email: sales@agstech.net

Web: <http://www.agstech.net>

