



High Reliability Industrial Ethernet Switch for Rugged Environment

2010 Product Catalog Vol.SW1006



Managed Ethernet Switches

Unmanaged Ethernet Switches

Media Converters

0

Table of Contents



1 Introduction

➤ Introduction	1-1
----------------	-----

2 Managed Ethernet Switches

➤ Overview	2-1
➤ Managed Ethernet Switches	2-5
➤ Real-time Redundant Ring Ethernet Switches	2-9
➤ Managed Ethernet Switches with Fiber Port	2-17
➤ Real-time Redundant Ring Ethernet Switches with Fiber Port	2-21

3 Unmanaged Ethernet Switches

➤ Unmanaged Ethernet Switches	3-1
➤ Unmanaged Ethernet Switches with Fiber Port	3-21
➤ Unmanaged Ethernet Switches with IP67 Water Proof	3-33

4 Media Converters

➤ Media Converters	4-1
--------------------	-----

5 Accessories

➤ Cables	5-1
➤ Power Supplies	5-1

6 Product Ordering Information

➤ Managed Ethernet Switches	6-1
➤ Unmanaged Ethernet Switches	6-2
➤ Media Converters	6-3
➤ Accessories	6-3

7 Related Products

➤ CAN Bus to Ethernet Gateway	7-1
➤ Serial Device to Ethernet Gateway	7-3
➤ Wireless ZigBee Series	7-9

Introduction

1

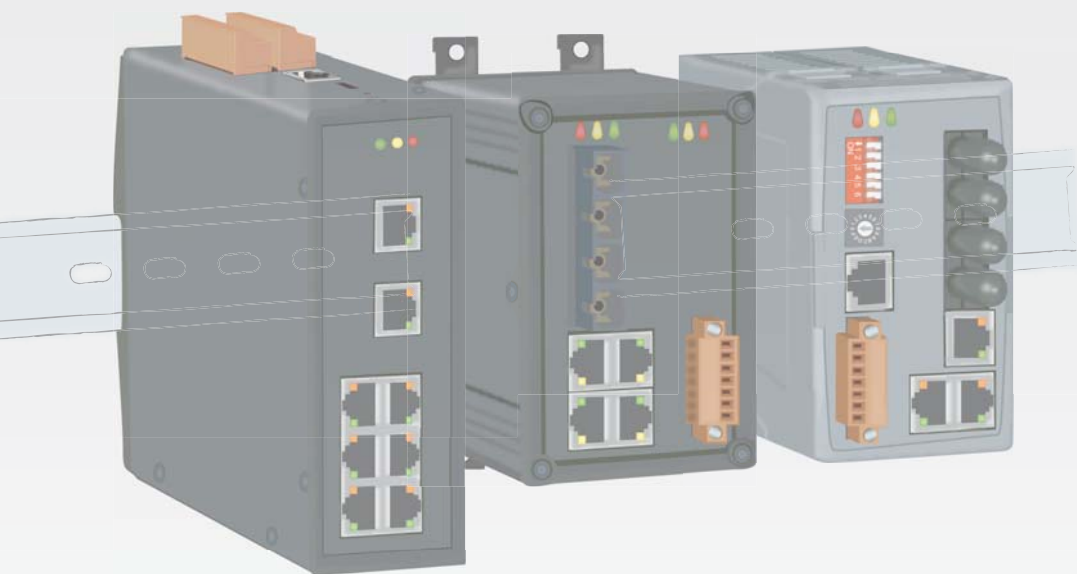

● Introduction

1

Introduction

Ethernet is an ideal medium to transport large volumes of data, at speed, across great distances. Previously, multiple networks carrying specific protocols were installed side by side to carry out unique tasks. This inevitably led to project costs increasing as additional fiber optic or copper cables were installed to deal with the increasing volume of data. Using Ethernet a single fiber optic cable can carry multiple protocols. Furthermore, manufacturers are exporting their legacy protocols onto Ethernet, designing new IP based communication protocols and providing embedded Web-Pages within devices that offer real-time information using simple tools like Internet Explorer and Netscape Navigator.

Early Ethernet were based on a hub or repeater. These units have no intelligence and therefore are unable to identify any information contained within the Header frame of an Ethernet packet. This means that it is not capable of determining which port to send the frame to. Therefore, every frame is sent to every port.

A switch, like a hub, has to forward and receive packets from one network or device to another. The switch could forward all packets, but if this was the case it would have similar behaviour to a hub. It would be more intelligent if the switch only forwarded packets which needed to travel from one network or device to another.

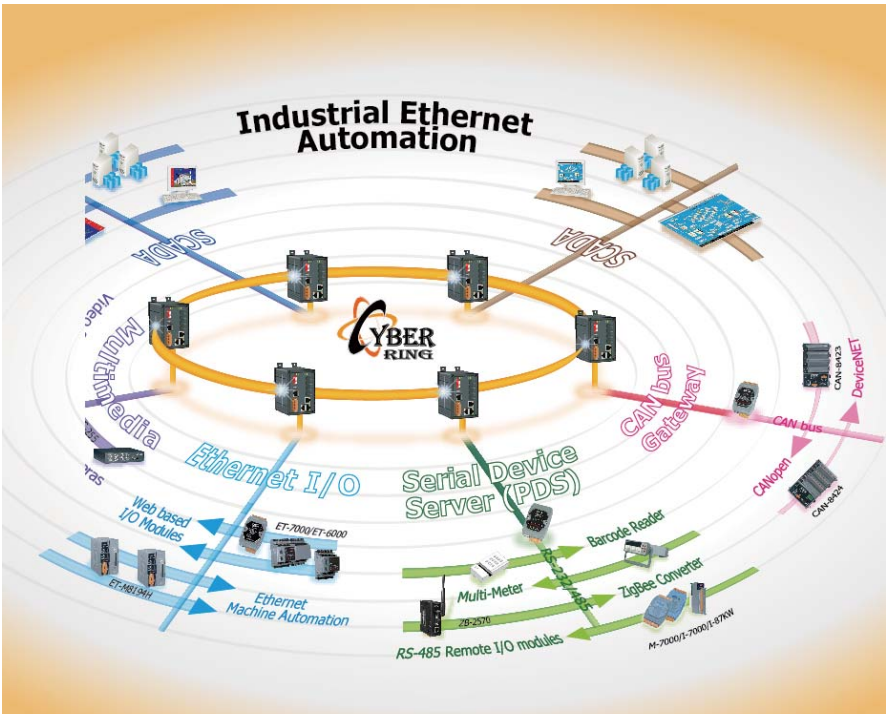

There are many poorly designed switches existing in the market, and most of them are fragile, easy to collapse, and always suffer from transmission delay and unreliable communication conditions due to packet collisions or other issues. Users who have bad experiences with those poor switches should try our high quality ones. ICP DAS's switches only choose "REAL INDUSTRIAL" grade switch chips that are temperature tolerant and highly reliable. They are all well-designed by skilled engineers and passed very strict communication and environment tests. All our switches can serve for a long life and guarantee to function perfectly under harsh environment.

■ Unmanaged Ethernet Switch

Industrial rated switches are intended to be installed in both harsh climatic environments and noisy electrical installations. Such switches are an excellent example of true industrial design principles

- Very high operating temperatures (down to -40 °C and up to 75 °C)
- DIN-Rail
- Wide DC operating voltages



■ Media Converter

The utilization of fiber optic data transmission for industrial automation and process control has become increasingly popular over the past decade. A basic fiber optic system, using an optical transceiver circuit and fiber optic media, offers a wide array of benefits that are not available with traditional copper conductors.

■ IP67 Water Proof Switch

IP67 Ethernet Switches are designed for use in industrial waterproof/harsh environments. The rugged packaging and IP67 connectors guarantee a total protection that can withstand a variety of extreme conditions such as high temperatures, extreme shocks & vibrations, dust particles or even liquid immersion. They can be directly mounted to any machine or convenient flat surface.



Real-time Redundant Ring Switch

The Real-time Redundant Ring Switch offers fault-tolerant industrial ethernet with ring network topology. The built-in ICP DAS proprietary Cyber-Ring technology detects and recovers from a fiber or copper link failure within approximately 50 ms – for the majority of applications a seamless process. Modbus/TCP, Modbus/RTU and OPC supported, SCADA application can monitor status of Ethernet and fiber port with Modbus or OPC protocol. And, the relay output facility can deliver warning signal while dual power or network link failure.

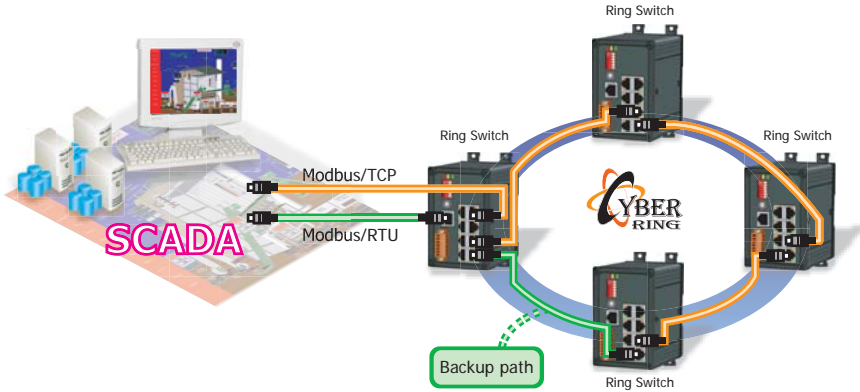

Managed Ethernet Switch

The ICP DAS Managed Switch provides a cost-effective managed ethernet solution for industrial control and automation. It provides lots of powerful managed functions, such as 802.1Q Tag-based VLAN, Port-based VLAN, 802.1p QoS (Quality of Service), Port Trunking, Spanning Tree, Cable Testing and Port Mirroring. These managed functions can be configured through RS-232 port via serial console or ethernet port using telnet or Web browser. In addition, the built-in Cyber-Ring technology offers real-time fault-tolerant ring topology to increase the reliability and performance of network. This is an ideal Managed Switch for industrial environments.



Managed Ethernet Switches

2

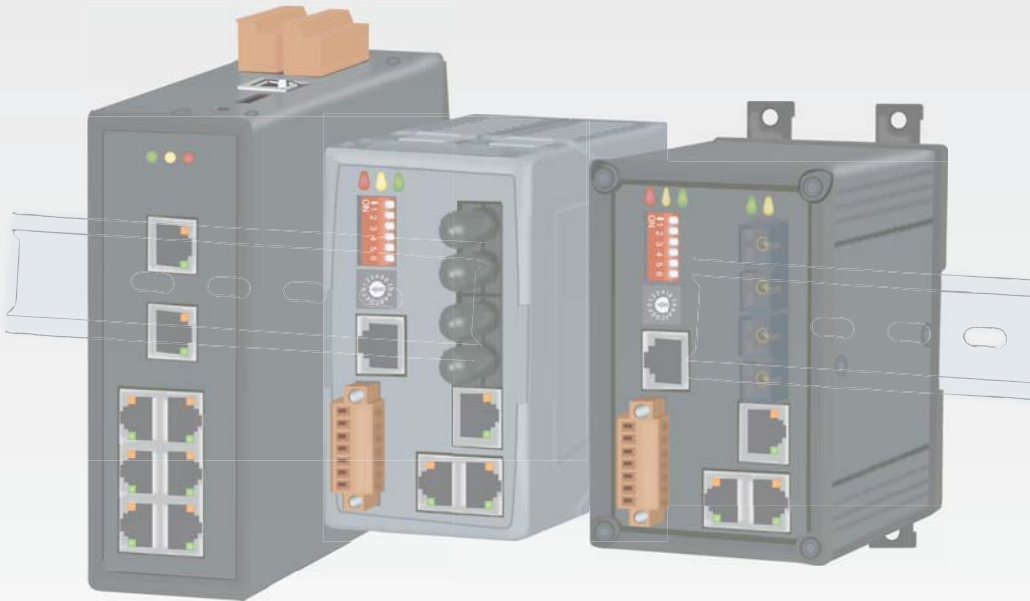

Managed Ethernet Switches

2

The managed switch can be configured through RS-232 port via serial console or Ethernet port using telnet or Web browser. In addition, the switch supports a lot of powerful managed functions, such as 802.1Q Tag-based VLAN, Port-based VLAN, 802.1p QoS (Quality of Service), Port Trunking, Spanning Tree, Cable Testing and Port Mirroring.

Built-in ICP DAS Cyber-Ring technique that enable multiple switches to be placed into a redundant ring. The switch detects and recovers from a fiber or copper link failure within approximately 50 ms – for the majority of applications a seamless process. Modbus/TCP, Modbus/RTU and OPC supported, SCADA application can monitor status of Ethernet and fiber port with Modbus or OPC protocol.

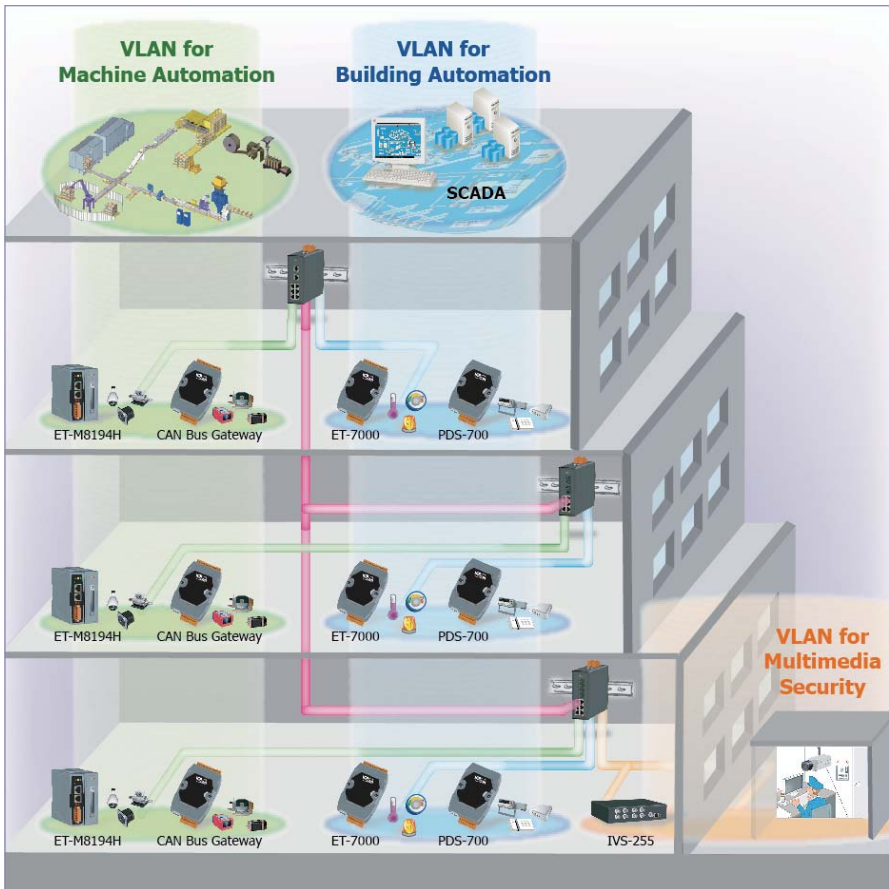

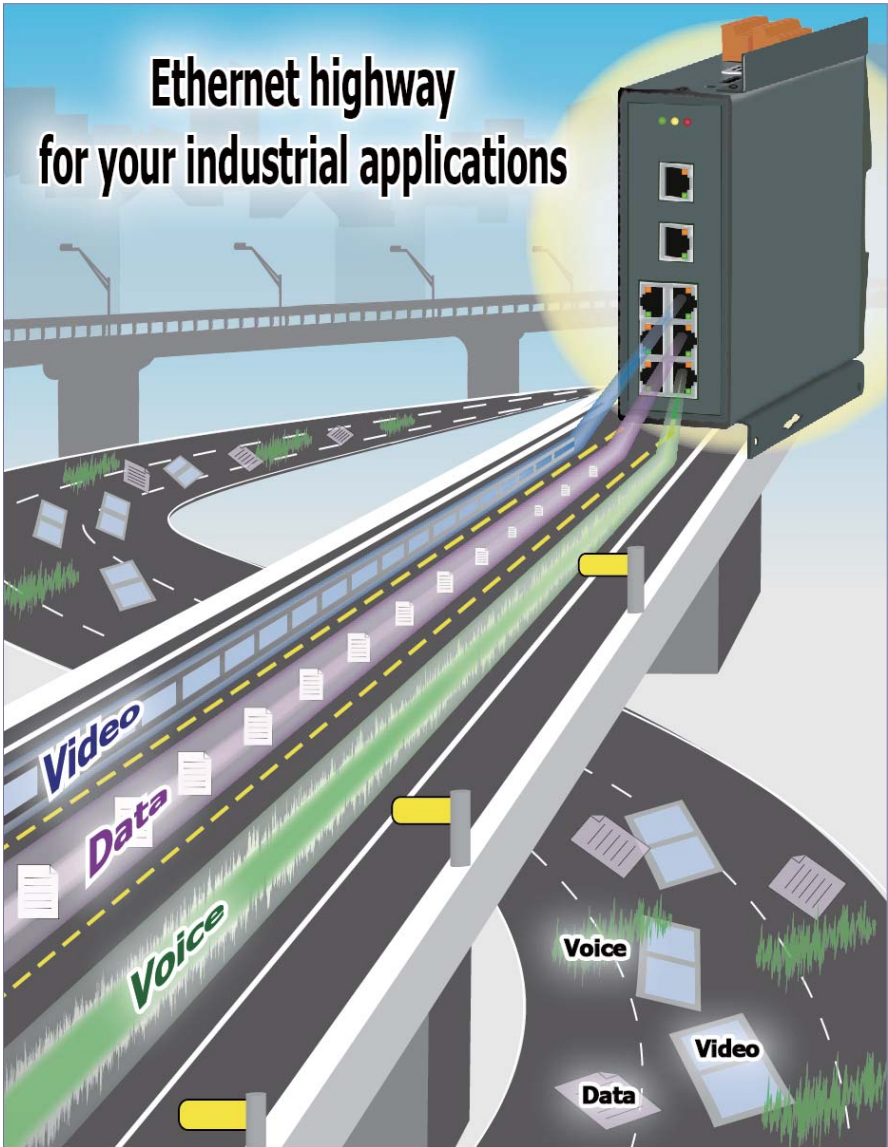

● Cyber-Ring Ethernet Self-healing Technology

It is undoubted that the power of an Ethernet LAN (Local Area Network) is tremendous when applied to factory floor or industrial automation applications. However, you cannot just use commercial Ethernet switch there. Harsh environment will become a challenge to your switch, and, in many case, fault-tolerant network is also a must. To satisfy these, ICP DAS's Cyber-Ring technology provides you a rugged fault-tolerant, plug and play Ethernet solution.

The ICP DAS's proprietary Cyber-Ring self-healing Ethernet technology can establish industrial ethernet with high reliability and fault-tolerant capability. It can employ a ring topology network of either copper or fiber optic cable. While standard STP typically requires 20s to 30s to reconfiguration network structure following a link failure, Cyber-Ring technology reduces this downtime to within half a second. Average experience indicates a typical fault recovery time is 300 ms for Cyber-Ring fault-tolerant network.

Features

- High reliability and fault-tolerant
- Real-time deterministic performance
- Scalable and flexible ring topology
- Cost-effective industrial redundant ethernet solution
- Plug and play

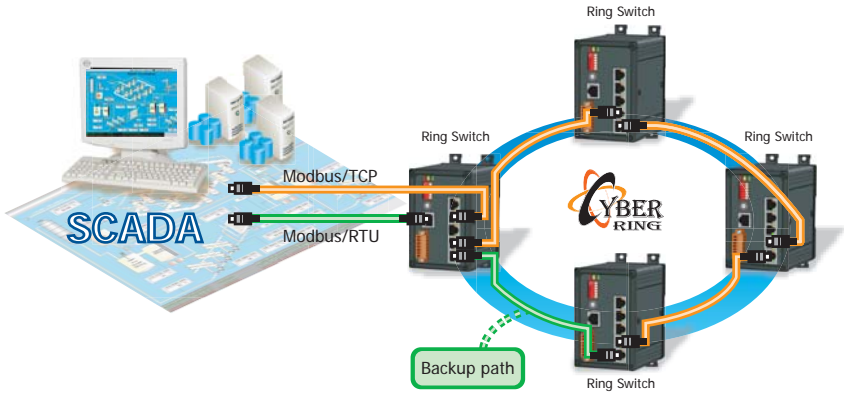

Recovery Time

The recovery time of Cyber-Ring network consists of two parts, fault detected time and reconfiguration time. Recovery time of Cyber-Ring network is associated with the number of switches of the network and Cyber-Ring technology offers a variable preconfigured recovery time to support a wide range of number of switches. Typically, the recovery time of Cyber-Ring network with ten switches is less than 300 ms.

Fault Detected Time

Fault detected time is defined as the time from the occurrence of the fault until fault detected. There is a master switch of Cyber-Ring network checks the health condition of Cyber-Ring network periodically. If active path is not response after a preconfigured period of time the master assumes that active path is failure and invokes reconfiguration mechanism to redirect traffics to the backup path.

Reconfiguration Time

The reconfiguration time of Cyber-Ring network is less than 5 ms per switch. For example, a Cyber-Ring fault-tolerant network that was comprised of ten switches, the expected worst case reconfiguration time was 50 ms. When a fault is detected, the Cyber-Ring network will reconfigure to provide alternate traffic path of the ring within 50 ms.

● Selection Guide

Managed Ethernet Switches

Model Name	Speed	Port	Operating Temperature	Redundant Power	Casing	Page
MSM-508	10/100 M	8	-40 ~ 75 °C	DC +12 ~ 48 V	Metal	2-5

Real-time Redundant Ring Ethernet Switches

Model Name	Speed	Port	Operating Temperature	Redundant Power	Casing	Page
RS-405	10/100 M	5	-40 ~ 75 °C	DC +10 ~ 30 V	Plastic	2-9
RSM-405	10/100 M	5	-40 ~ 75 °C	DC +10 ~ 30 V	Metal	2-9
RS-408	10/100 M	8	-40 ~ 75 °C	DC +10 ~ 30 V	Plastic	2-13
RSM-408	10/100 M	8	-40 ~ 75 °C	DC +10 ~ 30 V	Metal	2-13

Managed Ethernet Switches with Fiber Port

Model Name	Fiber Optics				Ethernet		Redundant Power	Operating Temperature	Casing	Page
	Mode	Connector	Speed	Port	Speed	Port				
MSM-508FC	Multi-mode	SC	100 M	2	10/100 M	6	DC +12 ~ 48 V	0 ~ 70 °C	Metal	2-17
MSM-508FCS	Single-mode	SC	100 M	2	10/100 M	6	DC +12 ~ 48 V	0 ~ 70 °C	Metal	2-17
MSM-508FT	Multi-mode	ST	100 M	2	10/100 M	6	DC +12 ~ 48 V	0 ~ 70 °C	Metal	2-17

Real-time Redundant Ring Ethernet Switches with Fiber Port

Model Name	Fiber Optics				Ethernet		Redundant Power	Operating Temperature	Casing	Page
	Mode	Connector	Speed	Port	Speed	Port				
RS-405FC	Multi-mode	SC	100 M	2	10/100 M	3	DC +10 ~ 30 V	0 ~ 70 °C	Plastic	2-21
RSM-405FC	Multi-mode	SC	100 M	2	10/100 M	3	DC +10 ~ 30 V	0 ~ 70 °C	Metal	2-21
RS-405FCS	Single-mode	SC	100 M	2	10/100 M	3	DC +10 ~ 30 V	0 ~ 70 °C	Plastic	2-21
RSM-405FCS	Single-mode	SC	100 M	2	10/100 M	3	DC +10 ~ 30 V	0 ~ 70 °C	Metal	2-21
RS-405FT	Multi-mode	ST	100 M	2	10/100 M	3	DC +10 ~ 30 V	0 ~ 70 °C	Plastic	2-21
RSM-405FT	Multi-mode	ST	100 M	2	10/100 M	3	DC +10 ~ 30 V	0 ~ 70 °C	Metal	2-21

MSM-508



8-Port Industrial Ethernet Layer 2 Managed Switch

2

Managed Ethernet Switches

MSM-508

Highlight Information ▶▶▶



● Introduction

The MSM-508 is an 8-Port Industrial Ethernet (10/100 Base-TX) Layer 2 Managed Switch. MSM-508 supports 10/100M auto negotiation feature and auto MDI/MDI-X function. It can automatically switch the transmission speed (10 Mbps or 100 Mbps) for corresponding connections. The connectors of Ethernet port are shielded RJ-45. The shielded RJ-45 connectors offer a high reliability Ethernet environment for industrial control and automation.

It can be managed through RS-232 port via serial console or Ethernet port using telnet or Web browser. In addition, the switch supports a lot of powerful managed functions, such as 802.1Q Tag-based VLAN, Port-based VLAN, 802.1p QoS (Quality of Service), Port Trunking, Spanning Tree, Cable Testing and Port Mirroring. Built-in ICP DAS Cyber-Ring technique that enable multiple switches to be placed into a redundant ring. The switch detects and recovers from a fiber or copper link failure within approximately 50 ms – for the majority of applications a seamless process. Modbus/TCP, Modbus/RTU and OPC supported, SCADA application can monitor status of Ethernet port with Modbus or OPC protocol.

MSM-508 provides two power inputs that can be connected simultaneously to live DC power sources. If one of the power inputs fails, the other live source acts as a backup to automatically support the MSM-508's power needs. And, the relay output facility can deliver warning signal while dual power or network link failure.

● Features

- Automatic MDI/MDI-X crossover for plug-and-play
- Each port supports both 10/100 Mbps speed auto negotiation
- Store-and-forward architecture
- Full duplex IEEE 802.3x and half duplex backpressure flow control
- 3.2 Gbps high performance memory bandwidth
- Frame buffer memory: 1 Mbit
- Integrated look-up engine with dedicated 2048 unicast MAC addresses
- Supports +12 V_{DC} ~ +48 V_{DC}
Power failure alarm by relay output
- Supports operating temperatures from -40 °C ~ +75 °C
- DIN-Rail mount and Screw hole for wall mounting kit

● Specifications

Technology	
Standards	IEEE 802.3, 802.3u and 802.3x
Processing Type	Store & forward, wire speed switching
MAC Addresses	2048
Memory Bandwidth	3.2 Gbps
Frame Buffer Memory	1 Mbit
Flow Control	IEEE 802.3x flow control, back pressure flow control
Protocol	VLAN, QoS, Port Trunk, SMTP, TELNET
Interface	
RJ-45 Ports	10/100 Base-TX auto negotiation speed, F/H duplex mode, and auto MDI/MDI-X connection
LED Indicators	Power, 10/100M, Link/Act, Master
Ethernet Isolation	1500 V _{rms} 1 minute
COM1	RS-232 (TXD, RXD and GND): Non-isolation
COM2	RS-485 (D2+, D2-; self-tuner ASIC inside): Non-isolation
Frame Ground for EMS Protection	Yes
Digital Input/Output	
Digital Input	3-channel, Wet Contact, L: +11 V _{DC} Max., H: +19 V _{DC} ~ +30 V _{DC}
Digital Output	3-channel, Open Collector, Sink/NPN, 30V/100 mA Max.
Power	
Input Voltage Range	+12 V _{DC} ~ +48 V _{DC} (Non-isolation redundant input)
Power Consumption	0.25 A @ 24 V _{DC} , +/-5% arrowed with 100M Full duplex
Protection	Power reverse polarity protection
Frame Ground for EMS Protection	Yes
Connection	20-Pin Removable Terminal Block
Mechanical	
Casing	Metal
Environmental Rating	IP30 Protection
Dimensions	47 mm x 128 mm x 175 mm (W x L x H)
Installation	DIN-Rail or Wall mounting
Environmental	
Operating Temperature	-40 °C ~ +75 °C
Storage Temperature	-40 °C ~ +85 °C
Ambient Relative Humidity	10% ~ 90% RH, non-condensing
Include Cable	
CA-090510 x 1	

• LED Functions

Standard RJ-45 female connectors are provided. A standard RJ-45 plug cable is all that is necessary to connect your device to the unit since switch that supports auto crossover.

MSM-508 Series LED Indicator Functions

LED	Color	Description
Master	Red On	The switch is master of ring network
	Red Off	The switch is slave of ring network
PWR1	Orange On	Power input 1 is alive
	Orange Off	Power input 1 is offline
PWR2	Green On	Power input 2 is alive
	Green Off	Power input 2 is offline
Ethernet Port	Orange On	Link to 100 Mbps
	Orange Off	Link to 10 Mbps
	Orange Blink	Backup Port
	Green Blink	Data Transmission

• Serial Port

10-Pin RJ-45 Serial Port Pin-Out

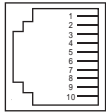

Pin#	Signal Name	Function
1	NC	No Connection
2	NC	No Connection
3	NC	No Connection
4	GND	RS-232 Ground
5	TXD	RS-232 TXD
6	RXD	RS-232 RXD
7	NC	No Connection
8	NC	No Connection
9	NC	No Connection
10	NC	No Connection

• Appearance

Redundant power inputs
Relay output, Digital Input/Output, RS-485

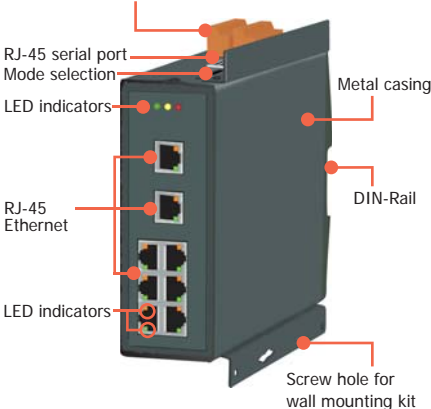

• Redundant Power Inputs

Both power inputs can be connected simultaneously to live DC power sources. If one power source fails, the other live source acts as a backup, and automatically supplies all of MSM-508 power needs.

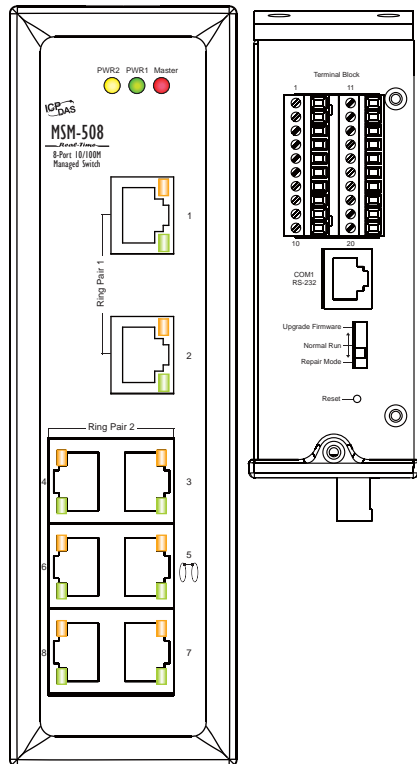
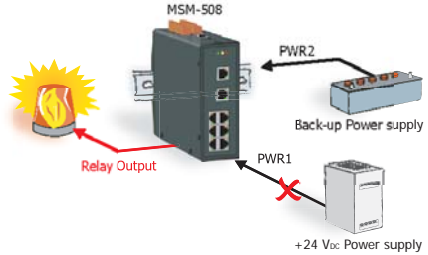

● Dimensions (Unit: mm)

DIN-Rail

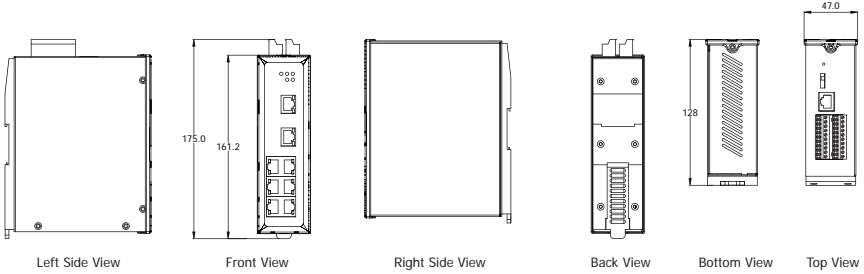

Wall Mounting

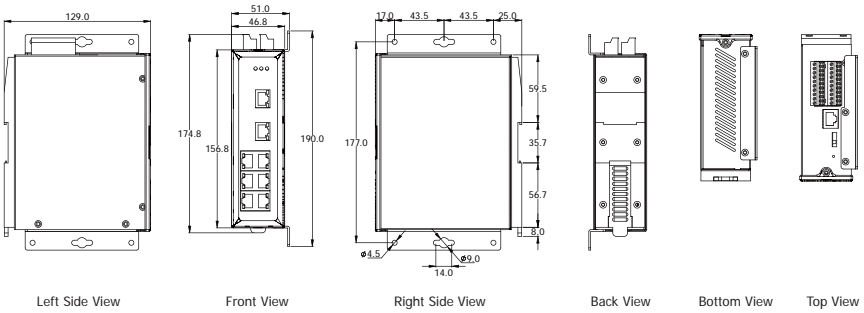

● Ordering Information

MSM-508 CR	8-Port Layer 2 Managed Switch with Metal Casing (RoHS)
------------	--

● Accessories

CA-090510	9-Pin Female D-Sub & RJ-45 Cable, 1M Cable
MDR-20-24	24V/1A, 24 W Power Supply with DIN-Rail Mounting
KWM020-1824F	24V/0.75A, 18 W Power Supply
DIN-KA52F	24V/1.04A, 25 W Power Supply with DIN-Rail Mounting

RS-405/RSM-405 Series



5-Port Real-time Redundant Ring Switch

2

Managed Ethernet Switches

RS-405/RSM-405 Series

Highlight Information ▶▶▶

RS-405/RSM-405 Series

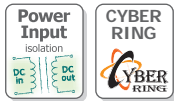
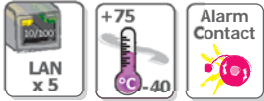

For RSM-405 Series



For RS-405 Series



RSM-405 Series



RS-405 Series



● Introduction

The RS-405/RSM-405 series is a 5-Port Industrial Ethernet (10/100 Base-TX) Real-Time Redundant Ring Switch. RS-405/RSM-405 supports 10/100M auto negotiation feature and auto MDI/MDI-X function. It can automatically switch the transmission speed (10 Mbps or 100 Mbps) for corresponding connections. Built-in ICP DAS Cyber-Ring technique that enable multiple switches to be placed into a redundant ring. It detects and recovers from a copper link failure within approximately 300 ms – for the majority of applications a seamless process.

● Features

- Automatic MDI/MDI-X crossover for plug-and-play
- Each port supports both 10/100 Mbps speed auto negotiation
- Store-and-forward architecture
- Full duplex IEEE 802.3x and half duplex backpressure flow control
- 3.2 Gbps high performance memory bandwidth
- Frame buffer memory: 1 Mbit
- Integrated look-up engine with dedicated 2048 unicast MAC addresses
- Redundant Power Inputs +10 V_{DC} ~ +30 V_{DC}
Power failure alarm by relay output
- Supports operating temperatures from -40 °C ~ +75 °C
- DIN-Rail

● Specifications

Models	RS-405	RSM-405
Technology		
Standards	IEEE 802.3, 802.3u and 802.3x	
Processing Type	Store & forward, wire speed switching	
MAC Addresses	2048	
Memory Bandwidth	3.2 Gbps	
Frame Buffer Memory	1 Mbit	
Flow Control	IEEE 802.3x flow control, back pressure flow control	
Interface		
RJ-45 Ports	10/100 Base-TX auto negotiation speed, F/H duplex mode, and auto MDI/MDI-X connection	
LED Indicators	Power, 10/100M, Link/Act, Master	
Ethernet Isolation	1500 V _{rms} 1 minute	
COM1	RS-232 (TXD, RXD and GND); Non-isolation	
COM2	RS-485 (D2+, D2-; self-tuner ASIC inside); Non-isolation	
Frame Ground for EMS Protection	Yes	
Power		
Input Voltage Range	+10 V _{DC} ~ +30 V _{DC} (Isolation redundant input)	
Power Consumption	0.22 A @ 24 V _{DC} , +/-5% arrowed with 100M Full duplex	
Protection	Power reverse polarity protection	
Frame Ground for EMS Protection	Yes	
Connection	7-Pin Removable Terminal Block	
Mechanical		
Casing	Plastic (Flammability UL 94V-0)	Metal (IP30 Protection)
Dimensions (W x L x H)	64 mm x 98 mm x 118 mm	73 mm x 102 mm x 132 mm
Installation	DIN-Rail	DIN-Rail or Wall Mounting
Environmental		
Operating Temperature	-40 °C ~ +75 °C	
Storage Temperature	-40 °C ~ +85 °C	
Ambient Relative Humidity	10% ~ 90% RH, non-condensing	
Include Cable		
CA-090510 x 1		

LED Functions

Standard RJ-45 female connectors are provided. A standard RJ-45 plug cable is all that is necessary to connect your device to the unit since switch that supports auto crossover.

RS/RSM-405 Series LED Indicator Functions

LED	Color	Description
Master	Red On	The switch is master of ring network
	Red Off	The switch is slave of ring network
PWR1	Orange On	Power input 1 is alive
	Orange Off	Power input 1 is offline
PWR2	Green On	Power input 2 is alive
	Green Off	Power input 2 is offline
Ethernet Port	Orange On	Link to 100 Mbps
	Orange Blink	Backup Port
	Green Blink	Data Transmission

Serial Port

10-Pin RJ-45 Serial Port Pin-Out

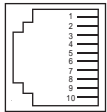

Pin#	Signal Name	Function
1	NC	No Connection
2	D+	RS-485 D+
3	D-	RS-485 D-
4	GND	RS-232 Ground
5	TXD	RS-232 TXD
6	RXD	RS-232 RXD
7	NC	No Connection
8	NC	No Connection
9	NC	No Connection
10	NC	No Connection

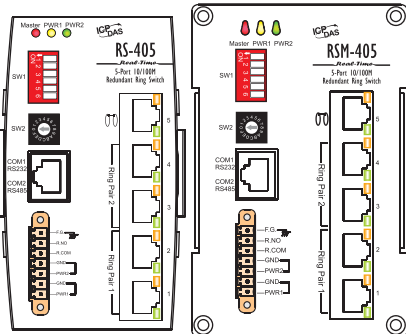

Redundant Power Inputs

Both power inputs can be connected simultaneously to live DC power sources. If one power source fails, the other live source acts as a backup, and automatically supplies all of RS-405/RSM-405 series power needs.

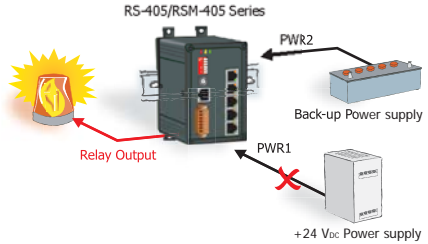

Appearance

RS-405 Series

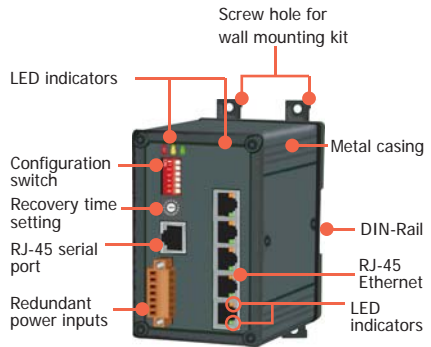

RSM-405 Series

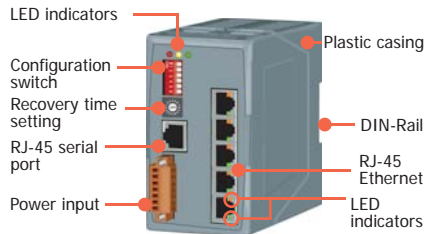

● Dimensions (Unit: mm)

RSM-405 Series

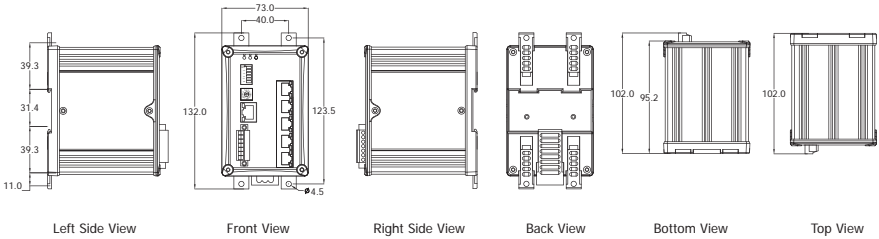

RS-405 Series

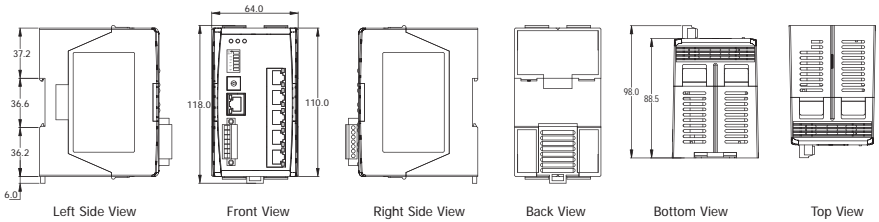

● Ordering Information

RS-405 CR	5-Port Redundant Ring Switch with Isolation Power Input +10 V _{DC} ~ +30 V _{DC} (RoHS)
RSM-405 CR	5-Port Redundant Ring Switch with Isolation Power Input +10 V _{DC} ~ +30 V _{DC} , metal casing (RoHS)
RS-405A CR	5-Port Redundant Ring Switch with Non-isolation Power Input +12 V _{DC} ~ +48 V _{DC} (RoHS)
RSM-405A CR	5-Port Redundant Ring Switch with Non-isolation Power Input +12 V _{DC} ~ +48 V _{DC} , metal casing (RoHS)

● Accessories

CA-090510	9-Pin Female D-Sub & RJ-45 Cable, 1M Cable
GPSU06-6	24V/0.25A, 6 W Power Supply
KWM020-1824F	24V/0.75A, 18 W Power Supply
DIN-KA52F	24V/1.04A, 25 W Power Supply with DIN-Rail Mounting

RS-408/RSM-408 Series



8-Port Real-time Redundant Ring Switch

2

Managed Ethernet Switches

RS-408/RSM-408 Series

Highlight Information ▶▶▶

RS-408/RSM-408 Series

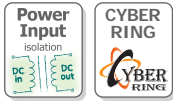
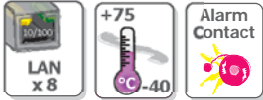

For RSM-408 Series



For RS-408 Series



RSM-408 Series



RS-408 Series



● Introduction

The RS-408/RSM-408 series is an 8-Port Industrial Ethernet (10/100 Base-TX) Real-Time Redundant Ring Switch. RS-408/RSM-408 supports 10/100M auto negotiation feature and auto MDI/MDI-X function. It can automatically switch the transmission speed (10 Mbps or 100 Mbps) for corresponding connections. Built-in ICP DAS Cyber-Ring technique that enable multiple switches to be placed into a redundant ring. It detects and recovers from a copper link failure within approximately 300 ms – for the majority of applications a seamless process.

● Features

- Automatic MDI/MDI-X crossover for plug-and-play
- Each port supports both 10/100 Mbps speed auto negotiation
- Store-and-forward architecture
- Full duplex IEEE 802.3x and half duplex backpressure flow control
- 3.2 Gbps high performance memory bandwidth
- Frame buffer memory: 1 Mbit
- Integrated look-up engine with dedicated 2048 unicast MAC addresses
- Redundant Power Inputs +10 V_{DC} ~ +30 V_{DC}
Power failure alarm by relay output
- Supports operating temperatures from -40 °C ~ +75 °C
- DIN-Rail

● Specifications

Models	RS-408	RSM-408
Technology		
Standards	IEEE 802.3, 802.3u and 802.3x	
Processing Type	Store & forward, wire speed switching	
MAC Addresses	2048	
Memory Bandwidth	3.2 Gbps	
Frame Buffer Memory	1 Mbit	
Flow Control	IEEE 802.3x flow control, back pressure flow control	
Interface		
RJ-45 Ports	10/100 Base-TX auto negotiation speed, F/H duplex mode, and auto MDI/MDI-X connection	
LED Indicators	Power, 10/100M, Link/Act, Master	
Ethernet Isolation	1500 V _{rms} 1 minute	
COM1	RS-232 (TXD, RXD and GND); Non-isolation	
COM2	RS-485 (D2+, D2-; self-tuner ASIC inside); Non-isolation	
Frame Ground for EMS Protection	Yes	
Power		
Input Voltage Range	+10 V _{DC} ~ +30 V _{DC} (Isolation redundant input)	
Power Consumption	0.3 A @ 24 V _{DC} , +/- 5% arrowed with 100M Full duplex	
Protection	Power reverse polarity protection	
Frame Ground for EMS Protection	Yes	
Connection	7-Pin Removable Terminal Block	
Mechanical		
Casing	Plastic (Flammability UL 94V-0)	Metal (IP30 Protection)
Dimensions (W x L x H)	64 mm x 98 mm x 118 mm	73 mm x 102 mm x 132 mm
Installation	DIN-Rail	DIN-Rail or Wall Mounting
Environmental		
Operating Temperature	-40 °C ~ +75 °C	
Storage Temperature	-40 °C ~ +85 °C	
Ambient Relative Humidity	10% ~ 90% RH, non-condensing	
Include Cable		
CA-090510 x 1		

LED Functions

Standard RJ-45 female connectors are provided. A standard RJ-45 plug cable is all that is necessary to connect your device to the unit since switch that supports auto crossover.

RS/RSM-408 Series LED Indicator Functions

LED	Color	Description
Master	Red On	The switch is master of ring network
	Red Off	The switch is slave of ring network
PWR1	Orange On	Power input 1 is online
	Orange Off	Power input 1 is offline
PWR2	Green On	Power input 2 is online
	Green Off	Power input 2 is offline
Ethernet Port	Orange On	Link to 100 Mbps
	Orange Off	Link to 10 Mbps
	Orange Blink	Backup Port
	Green Blink	Data Transmission

Serial Port

10-Pin RJ-45 Serial Port Pin-Out

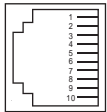

Pin#	Signal Name	Function
1	NC	No Connection
2	D+	RS-485 D+
3	D-	RS-485 D-
4	GND	RS-232 Ground
5	TXD	RS-232 TXD
6	RXD	RS-232 RXD
7	NC	No Connection
8	NC	No Connection
9	NC	No Connection
10	NC	No Connection

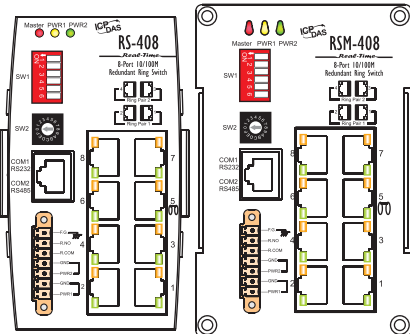

Redundant Power Inputs

Both power inputs can be connected simultaneously to live DC power sources. If one power source fails, the other live source acts as a backup, and automatically supplies all of RS-408/RSM-408 series power needs.

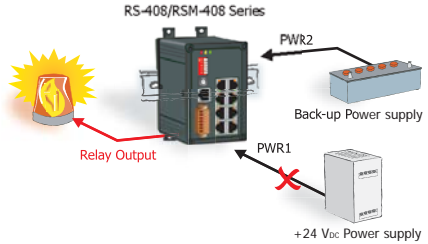

Appearance

RS-408 Series

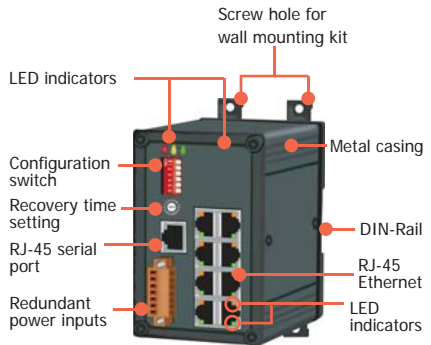

RS-408 Series

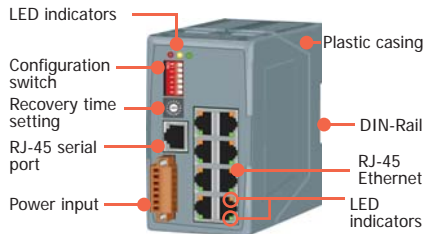

● Dimensions (Unit: mm)

RSM-408 Series

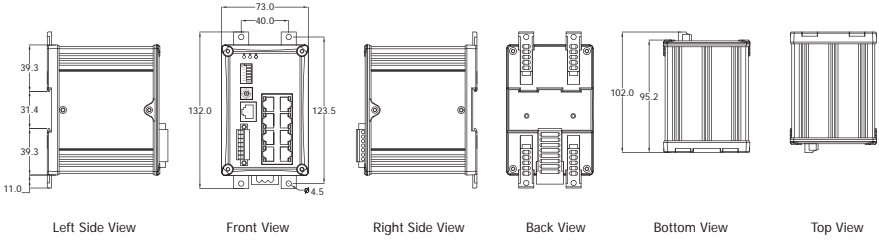

RS-408 Series

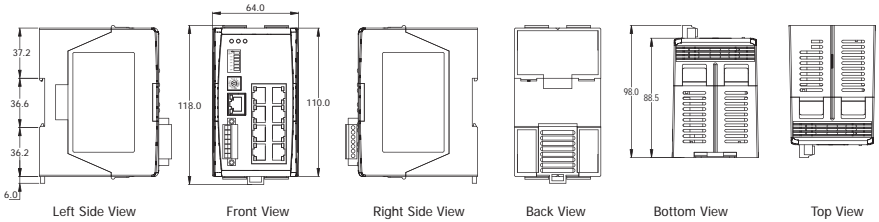

● Ordering Information

RS-408 CR	8-Port Redundant Ring Switch with Isolation Power Input +10 V _{DC} ~ +30 V _{DC} (RoHS)
RSM-408 CR	8-Port Redundant Ring Switch with Isolation Power Input +10 V _{DC} ~ +30 V _{DC} , metal casing (RoHS)
RS-408A CR	8-Port Redundant Ring Switch with Non-isolation Power Input +12 V _{DC} ~ +48 V _{DC} (RoHS)
RSM-408A CR	8-Port Redundant Ring Switch with Non-isolation Power Input +12 V _{DC} ~ +48 V _{DC} , metal casing (RoHS)

● Accessories

CA-090510	9-Pin Female D-Sub & RJ-45 Cable, 1M Cable
MDR-20-24	24V/1A, 24 W Power Supply with DIN-Rail Mounting
KWM020-1824F	24V/0.75A, 18 W Power Supply
DIN-KA52F	24V/1.04A, 25 W Power Supply with DIN-Rail Mounting

MSM-508F Series



8-Port Industrial Ethernet Layer 2 Managed Switch with 2-Fiber Port

2

Managed Ethernet Switches

MSM-508F Series

Highlight Information ▶▶▶



MSM-508FC/FCS-T Series

MSM-508FT-T Series



● Introduction

The MSM-508F series is an 8-Port Industrial Ethernet Layer 2 Managed Switch with 2-Fiber Port that secures data transmission by using fiber optic transmission to provide immunity from EMI/RFI interference. It is perfect solution for applications where transmission must be protected from electrical exposure, surges, lightning or chemical corrosion.

It can be managed through RS-232 port via serial console or Ethernet port using telnet or Web browser. In addition, the switch supports a lot of powerful managed functions, such as 802.1Q Tag-based VLAN, Port-based VLAN, 802.1p QoS (Quality of Service), Port Trunking, Spanning Tree, Cable Testing and Port Mirroring.

Built-in ICP DAS Cyber-Ring technique that enable multiple switches to be placed into a redundant ring. The switch detects and recovers from a fiber or copper link failure within approximately 300 ms – for the majority of applications a seamless process. Modbus/TCP, Modbus/RTU and OPC supported, SCADA application can monitor status of Ethernet and fiber port with Modbus or OPC protocol.

MSM-508F provides two power inputs that can be connected simultaneously to live DC power sources. If one of the power inputs fails, the other live source acts as a backup to automatically support the MSM-508F's power needs. And, the relay output facility can deliver warning signal while dual power or network link failure.

● Features

- Automatic MDI/MDI-X crossover for plug-and-play
- Each port supports both 10/100 Mbps speed auto negotiation
- Store-and-forward architecture
- Full duplex IEEE 802.3x and half duplex backpressure flow control
- 3.2 Gbps high performance memory bandwidth
- Frame buffer memory: 1 Mbit
- Integrated look-up engine with dedicated 2048 unicast MAC addresses
- Supports +12 ~ +48 V_{DC}
Power failure alarm by relay output
- Supports operating temperatures from -40 °C ~ +75 °C
- DIN-Rail mount and Screw hole for wall mounting kit

Specifications

Models	MSM-508FC/FCS-T Series	MSM-508FT-T Series
Technology		
Standards	IEEE 802.3, 802.3u, 802.3x	
Processing Type	Store & forward, wire speed switching	
MAC Addresses	2048	
Memory Bandwidth	3.2 Gbps	
Frame Buffer Memory	1 Mbit	
Flow Control	IEEE 802.3x flow control, back pressure flow control	
Protocol	VLAN, QoS, Port Trunk, SMTP, TELNET	
Interface		
RJ-45 Ports	10/100 Base-TX auto negotiation speed, F/H duplex mode, and auto MDI/MDI-X connection	
Fiber Optics Port	100 Base-FX	
LED Indicators	10/100M, Link/Act, Full duplex/Half duplex (Fiber Port)	
Ethernet Isolation	1500 V _{rms} 1 minute	
Frame Ground for EMS Protection	Yes	
Multi Mode	Multi Mode Fiber Cables: 50/125, 62.5/125 or 100/140 μ m	
	Distance: 2 km, (62.5/125 μ m recommended) for full duplex	
	Wavelength: 1300 or 1310 nm	
	Min. TX Output: -20 dBm	
	Max. TX Output: -14 dBm	
Single Mode	RX Sensitivity: Max. -32 dBm	
	Single Mode Fiber Cables: 8.3/125, 8.7/125, 9/125 or 10/125 μ m	
	Distance: 15 km, (9/125 μ m recommended) for full duplex	
	Wavelength: 1300 or 1310 nm	
	Min. TX Output: -15 dBm	
Ethernet Transmission Distance	Max. TX Output: -8 dBm	
	RX Sensitivity: Max. -34 dBm	
	Ethernet: 2-pair UTP/STP Cat.3, 4, 5, EIA/TIA-568 100 Ω	
COM1	Fast Ethernet: 2-pair UTP/STP Cat. 5, EIA/TIA-568 100 Ω	
COM2	RS-232 (TXD, RXD and GND); Non-isolation	
Digital Input/Output	RS-485 (D2+, D2-; self-tuner ASIC inside); Non-isolation	
Digital Input	3-channel, Wet Contact, L: +11 V _{DC} Max., H: +19 V _{DC} ~ +30 V _{DC}	
Digital Output	3-channel, Open Collector, Sink/NPN, 30V/100 mA Max.	
Power		
Input Voltage Range	+12 V _{DC} ~ +48 V _{DC} (Non-isolation redundant input)	
Power Consumption	0.3 A @ 24 V _{DC} , +/-5% arrowed with 100M Full duplex	
LED Indicator	Yes	
Protection	Power reverse polarity protection	
Frame Ground for EMS Protection	Yes	
Mechanical		
Casing	Metal (IP30 Protection)	
Dimensions (W x L x H)	47 mm x 140 mm x 175 mm	47 mm x 142 mm x 175 mm
Installation	DIN-Rail or Wall Mounting	
Environmental		
Operating Temperature	-40 °C ~ +75 °C	
Storage Temperature	-40 °C ~ +85 °C	
Ambient Relative Humidity	10% ~ 90% RH, non-condensing	
Include Cable		
CA-090510 x 1		

LED Functions

Standard RJ-45 female connectors are provided. A standard RJ-45 plug cable is all that is necessary to connect your device to the unit since switch that supports auto crossover.

MSM-508F Series LED Indicator Functions

LED	Color	Description
Master	Red On	The switch is master of ring network
	Red Off	The switch is slave of ring network
PWR1	Orange On	Power input 1 is alive
	Orange Off	Power input 1 is offline
PWR2	Green On	Power input 2 is alive
	Green Off	Power input 2 is offline
Ethernet Port	Orange On	Link to 100 Mbps
	Orange Off	Link to 10 Mbps
	Orange Blink	Backup Port
	Green Blink	Data Transmission
Fiber Port	Green Blink	Fiber is active port
	Green Off	Fiber backup port

Serial Port

10-Pin RJ-45 Serial Port Pin-Out

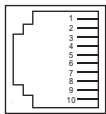

Pin#	Signal Name	Function
1	NC	No Connection
2	NC	No Connection
3	NC	No Connection
4	GND	RS-232 Ground
5	TXD	RS-232 TXD
6	RXD	RS-232 RXD
7	NC	No Connection
8	NC	No Connection
9	NC	No Connection
10	NC	No Connection

Appearance

Redundant power inputs
Relay output, Digital Input/Output, RS-485

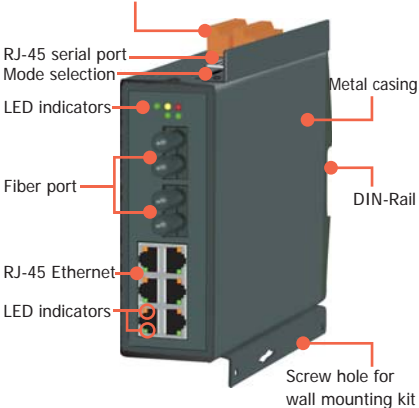

Redundant Power Inputs

Both power inputs can be connected simultaneously to live DC power sources. If one power source fails, the other live source acts as a backup, and automatically supplies all of MSM-508F series power needs.

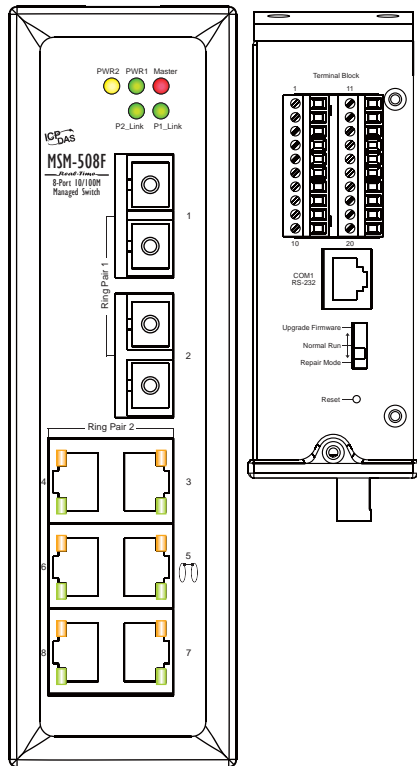
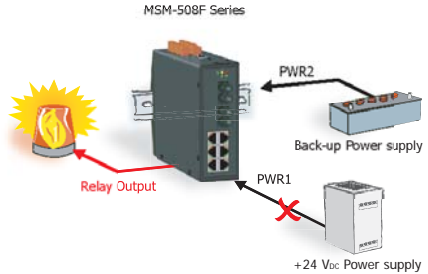

● Dimensions (Unit: mm)

DIN-Rail

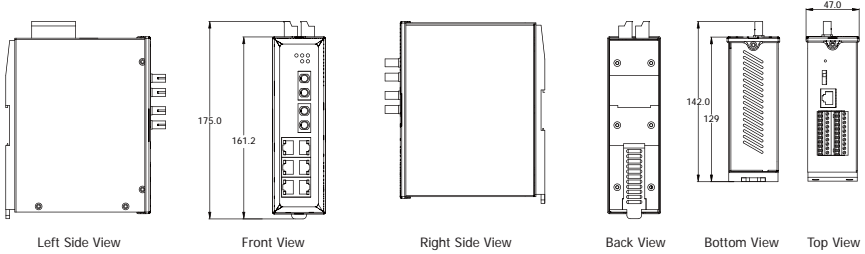

Wall Mounting

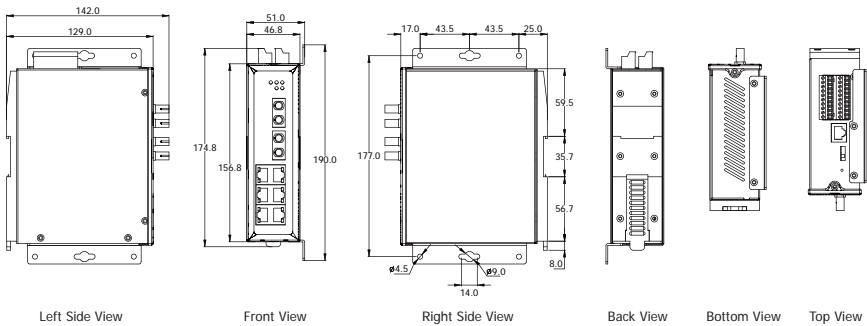

● Ordering Information

MSM-508F - 4 0 - 		
Single Mode Distance 40: 40 km Standard Models: 15 km		
Ordering Code Definition	Fiber Port Connector	Operating Temperature
	T: Multi Mode ST Connector C: Multi Mode SC Connector CS: Single Mode SC Connector	T: Operating Temp: -40 °C ~ +75 °C
Models	MSM-508FT-T MSM-508FC-T MSM-508FCS-T MSM-508FCS-40T	

● Accessories

CA-090510	9-Pin Female D-Sub & RJ-45 Cable, 1M Cable
MDR-20-24	24V/1A, 24 W Power Supply with DIN-Rail Mounting
KWM020-1824F	24V/0.75A, 18 W Power Supply
DIN-KA52F	24V/1.04A, 25 W Power Supply with DIN-Rail Mounting

RS-405F/RSM-405F Series



5-Port Real-time Redundant Ring Switch with 2-Fiber Port

2

Managed Ethernet Switches

RS-405F/RSM-405F Series

Highlight Information ▶▶▶

RS-405F/RSM-405F Series

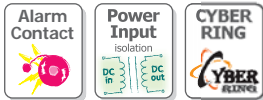

For RSM-405F Series



For RS-405F Series



RSM-405F Series



RS-405F Series



● Introduction

The RS-405F/RSM-405F series is a 5-port Industrial Ethernet Real-Time Redundant Ring Switch with 2-Fiber Port that secures data transmission by using fiber optic transmission to provide immunity from EMI/RFI interference.

Built-in ICP DAS Cyber-Ring technique that enable multiple switches to be placed into a redundant ring. It detects and recovers from a fiber or copper link failure within approximately 300 ms – for the majority of applications a seamless process.

● Features

- Automatic MDI/MDI-X crossover for plug-and-play
- Each port supports both 10/100 Mbps speed auto negotiation
- Store-and-forward architecture
- Full duplex IEEE 802.3x and half duplex backpressure flow control
- 3.2 Gbps high performance memory bandwidth
- Frame buffer memory: 512 Kbit
- Integrated look-up engine with dedicated 1024 unicast MAC addresses
- Redundant Power Inputs +10 V_{DC} ~ +30 V_{DC}
Power failure alarm by relay output
- Supports operating temperatures from 0 °C ~ +70 °C

● Specifications

Models	RS-405F Series	RSM-405F Series
Technology		
Standards	IEEE 802.3, 802.3u, 802.3x	
Processing Type	Store & forward, wire speed switching	
MAC Addresses	1024	
Memory Bandwidth	3.2 Gbps	
Frame Buffer Memory	512 Kbit	
Flow Control	IEEE 802.3x flow control, back pressure flow control	
Interface		
RJ-45 Ports	10/100 Base-TX auto negotiation speed, F/H duplex mode, and auto MDI/MDI-X connection	
Fiber Optics Port	100 Base-FX	
LED Indicators	10/100M, Link/Act, Full duplex/Half duplex (Fiber Port)	
Ethernet Isolation	1500 V _{rms} 1 minute	
Frame Ground for EMS Protection	Yes	
Multi Mode	Multi Mode Fiber Cables: 50/125, 62.5/125 or 100/140 μm	
	Distance: 2 km, (62.5/125 μm recommended) for full duplex	
	Wavelength: 1300 or 1310 nm	
	Min. TX Output: -20 dBm	
	Max. TX Output: -14 dBm	
Single Mode	Single Mode Fiber Cables: 8.3/125, 8.7/125, 9/125 or 10/125 μm	
	Distance: 15 km, (9/125 μm recommended) for full duplex	
	Wavelength: 1300 or 1310 nm	
	Min. TX Output: -15 dBm	
	Max. TX Output: -8 dBm	
Ethernet Transmission Distance	Ethernet: 2-pair UTP/STP Cat.3, 4, 5, EIA/TIA-568 100 Ω	
	Fast Ethernet: 2-pair UTP/STP Cat. 5, EIA/TIA-568 100 Ω	
COM1	RS-232 (TXD, RXD and GND); Non-isolation	
COM2	RS-485 (D2+, D2-; self-tuner ASIC inside); Non-isolation	
Power		
Input Voltage Range	+10 V _{DC} ~ +30 V _{DC} (Isolation redundant input)	
Power Consumption	0.4 A @ 24 V _{DC} , +/-5% arrowed with 100M Full duplex	
LED Indicator	Yes	
Protection	Power reverse polarity protection	
Frame Ground for EMS Protection	Yes	
Mechanical		
Casing	Plastic (Flammability UL 94V-0)	Metal (IP30 Protection)
Dimensions (W x L x H)	64 mm x 101 mm x 118 mm	73 mm x 105 mm x 132 mm
Installation	DIN-Rail	DIN-Rail or Wall Mounting
Environmental		
Operating Temperature	0 °C ~ +70 °C	
Storage Temperature	-20 °C ~ +85 °C	
Ambient Relative Humidity	10% ~ 90% RH, non-condensing	
Include Cable		
CA-090510 x 1		

LED Functions

Standard RJ-45 female connectors are provided. A standard RJ-45 plug cable is all that is necessary to connect your device to the unit since switch that supports auto crossover.

RS/RSM-405F Series LED Indicator Functions

LED	Color	Description
Master	Red On	The switch is master of ring network
	Red Off	The switch is slave of ring network
PWR1	Orange On	Power input 1 is online
	Orange Off	Power input 1 is offline
PWR2	Green On	Power input 2 is online
	Green Off	Power input 2 is offline
Ethernet Port	Orange On	Link to 100 Mbps
	Orange Off	Link to 10 Mbps
	Orange Blink	Backup Port
	Green Blink	Data Transmission
Fiber Port	Orange Blink	Fiber 1 is active port
	Orange Off	Fiber 1 is backup port
	Green Blink	Fiber 2 is active port
	Green Off	Fiber 2 is backup port

Serial Port

10-Pin RJ-45 Serial Port Pin-Out

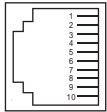

Pin#	Signal Name	Function
1	NC	No Connection
2	D+	RS-485 D+
3	D-	RS-485 D-
4	GND	RS-232 Ground
5	TXD	RS-232 TXD
6	RXD	RS-232 RXD
7	NC	No Connection
8	NC	No Connection
9	NC	No Connection
10	NC	No Connection

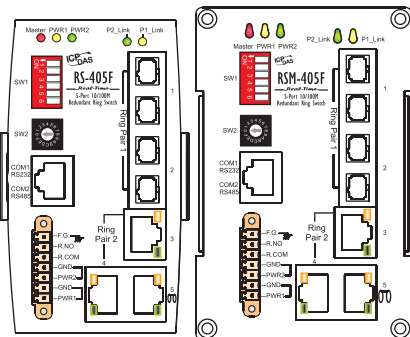

Redundant Power Inputs

Both power inputs can be connected simultaneously to live DC power sources.

If one power source fails, the other live source acts as a backup, and automatically supplies all of RS-405F/RSM-405F series power needs.

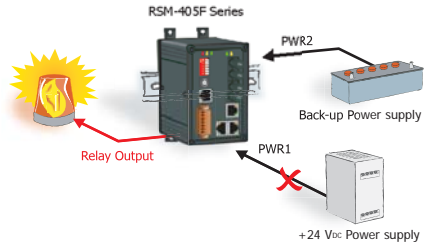

Appearance

RSM-405F Series

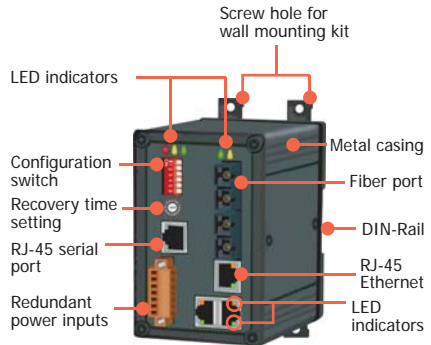

RS-405F Series

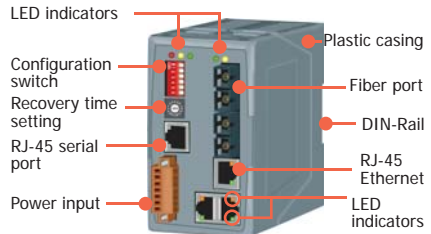

● Dimensions (Unit: mm)

RSM-405F Series

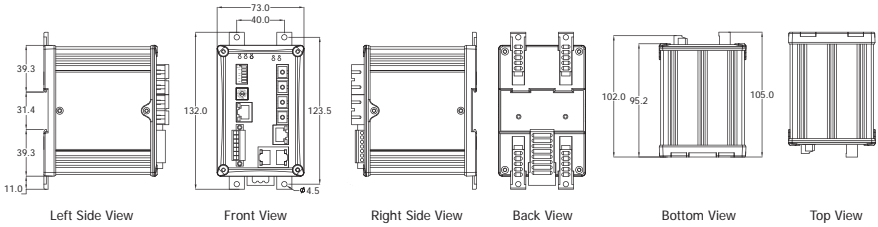

RS-405F Series

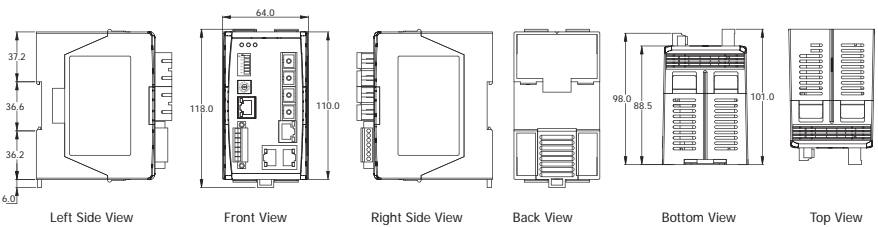

● Ordering Information

<p>RS M -405 A F - 4 0 - </p> <p>Single Mode Distance 40: 40 km Standard Models: 15 km</p>		
M: Metal	A: Power Input +12 V _{DC} ~ +48 V _{DC}	
Ordering Code Definition	Fiber Port Connector	Operating Temperature
	T: Multi Mode ST Connector C: Multi Mode SC Connector CS: Single Mode SC Connector	T: Operating Temp: -40 °C ~ +75 °C Standard Models: 0 °C ~ +70 °C
Models	RS-405FT, RSM-405FT RS-405FC, RSM-405FC RS-405FCS, RSM-405FCS RS-405AFT, RSM-405AFT RS-405AFC, RSM-405AFC RS-405AFCS, RSM-405AFCS	RS-405AFT-T, RSM-405AFT-T RS-405AFC-T, RSM-405AFC-T RS-405AFCS-T, RSM-405AFCS-T RS-405AFCS-40T, RSM-405AFCS-40T

● Accessories

CA-090510	9-Pin Female D-Sub & RJ-45 Cable, 1M Cable
MDR-20-24	24V/1A, 24 W Power Supply with DIN-Rail Mounting
KWM020-1824F	24V/0.75A, 18 W Power Supply
DIN-KA52F	24V/1.04A, 25 W Power Supply with DIN-Rail Mounting

● Managed Ethernet Switches

- Managed Switch for industrial application
- Web-based configuration
- QoS, VLAN, STP Supported
- Built-in Cyber-Ring Technology
- Dual Power Input
- Relay Alarm Output



● Real-time Redundant Ring Switches

- High reliability and fault-tolerant
- Real-time deterministic performance
- Scalable and flexible ring topology
- Cost-effective industrial redundant Ethernet solution
- Modbus remote monitoring
- Plug and play



Unmanaged Ethernet Switches

3

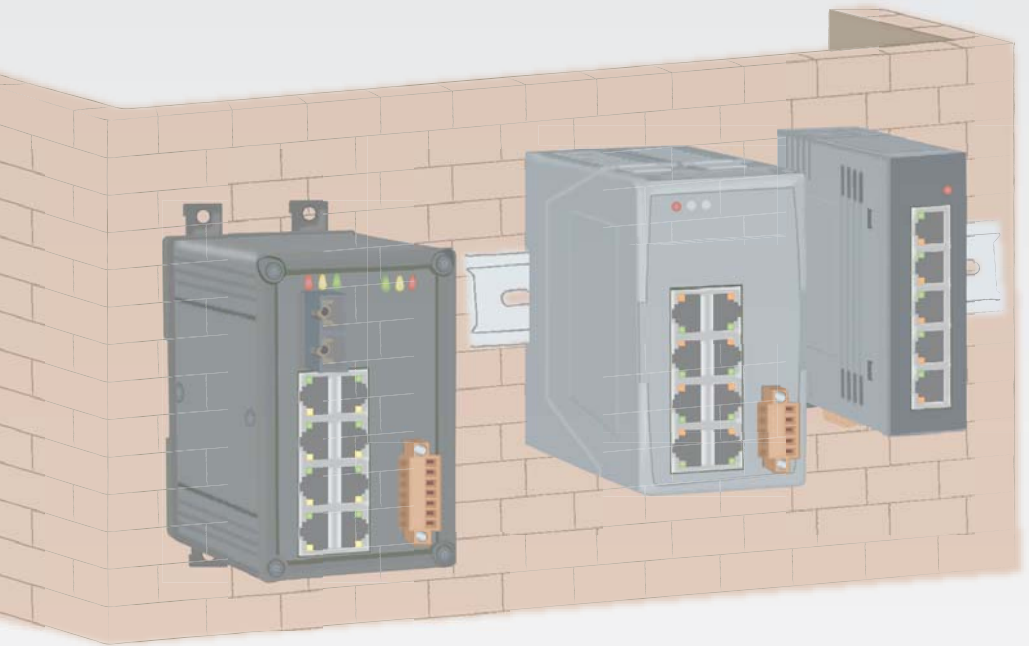

NS-205 Series

Unmanaged 5-Port Industrial Ethernet Switch

3

Unmanaged Ethernet Switches

NS-205 Series

Highlight Information ▶▶▶▶

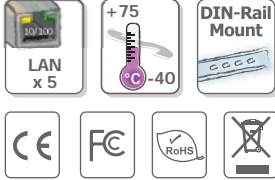

● Introduction

The NS-205 series has 5 Ethernet Switching ports that support 10/100 Base-TX, with a 10/100M auto negotiation feature and auto MDI/MDI-X function. It can connect 5 workstations and automatically switches the transmission speed (10 Mbps or 100 Mbps) for corresponding connections. The flow control mechanism is also negotiated. There is activity/link/data rate LEDs for each port to aid trouble-shooting. Port connectors are shielded RJ-45. It contains "soft start" function with overload protection, high-low voltage protection. The width of the NS-205 is just 33 mm, so it can be used where space is important.

● Features

- Automatic MDI/MDI-X crossover for plug-and-play
- Each port supports both 10/100 Mbps speed auto negotiation
- Store-and-forward architecture
- Full duplex IEEE 802.3x and half duplex backpressure flow control
- Integrated look-up engine with dedicated 1024 unicast MAC addresses
- Store-and-forward architecture
- Supports +10 V_{dc} ~ +30 V_{dc} Reverse Polarity Protection
- Supports operating temperatures from -40 °C ~ +75 °C
- DIN-Rail

● Specifications

Technology	
Standards	IEEE 802.3, 802.3u, 802.3x
Processing Type	Store & forward, wire speed switching
MAC Addresses	1024
Memory Bandwidth	1.4 Gbps
Frame Buffer Memory	256 Kbit
Flow Control	IEEE 802.3x flow control, back pressure flow control
Interface	
RJ-45 Ports	10/100 Base-TX auto negotiation speed, F/H duplex mode, and auto MDI/MDI-X connection
LED Indicators	Power, 10/100M, Link/Act
Ethernet Isolation	1500 V _{rms} 1 minute
Frame Ground for EMS Protection	Yes
Cable	Ethernet: 2-pair UTP/STP Cat.3, 4, 5, EIA/TIA-568 100 Ω
	Fast Ethernet: 2-pair UTP/STP Cat. 5, EIA/TIA-568 100 Ω
Power	
Input Voltage Range	+10 V _{DC} ~ +30 V _{DC} (Non-isolation)
Power Consumption	0.1 A @ 24 V _{DC} , +/-5% arrowed with 10M Full duplex
	0.09 A @ 24 V _{DC} , +/-5% arrowed with 100M Full duplex
Protection	Power reverse polarity protection
Frame Ground for EMS Protection	Yes
Connection	3-Pin Removable Terminal Block
Mechanical	
Casing	Plastic
Flammability	UL 94V-0
Dimensions	33 mm x 78 mm x 107 mm (W x L x H)
Installation	DIN-Rail
Environmental	
Operating Temperature	-40 °C ~ +75 °C
Storage Temperature	-40 °C ~ +85 °C
Ambient Relative Humidity	10% ~ 90% RH, non-condensing

LED Functions

LED Indicator Functions

LED	Color	Description
PWR	Red	Power is On
	Off	Power is Off
10/100M (Port 1)	Yellow	Link to 10 Mbps
	Green	Link to 100 Mbps
	Off	Not Networking
10/100M (Port 2)	Yellow	Link to 10 Mbps
	Green	Link to 100 Mbps
	Off	Not Networking
10/100M (Port 3)	Yellow	Link to 10 Mbps
	Green	Link to 100 Mbps
	Off	Not Networking
10/100M (Port 4)	Yellow	Link to 10 Mbps
	Green	Link to 100 Mbps
	Off	Not Networking
10/100M (Port 5)	Yellow	Link to 10 Mbps
	Green	Link to 100 Mbps
	Off	Not Networking

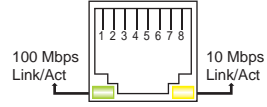
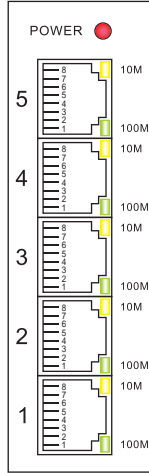

RJ-45 Pin-Out

Pin#	Signal Name	Function
1	TD+	Transmit Data
2	TD-	Transmit Data
3	RD+	Receive Data
4	NC	No Connection
5	NC	No Connection
6	RD-	Receive Data
7	NC	No Connection
8	NC	No Connection

Pin Function for Terminal Block

External power supply is connected using the removable terminal block:

+Vs : Power input (+10 V_{DC} ~ +30 V_{DC}) and should be connected to the power supply (+)

GND: Ground and should be connected to the power supply (-)

F.G. : F.G. stands for Frame Ground (protective ground). It is optional. If you use this pin, it can reduce EMI radiation; improve EMI performance and ESD protection.

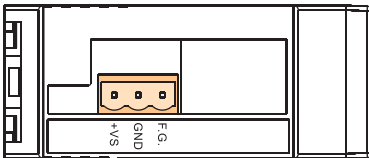

● Appearance

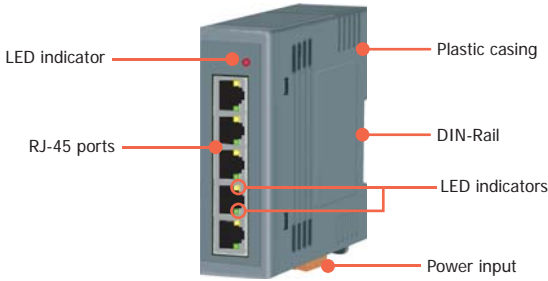

● Dimensions (Unit: mm)

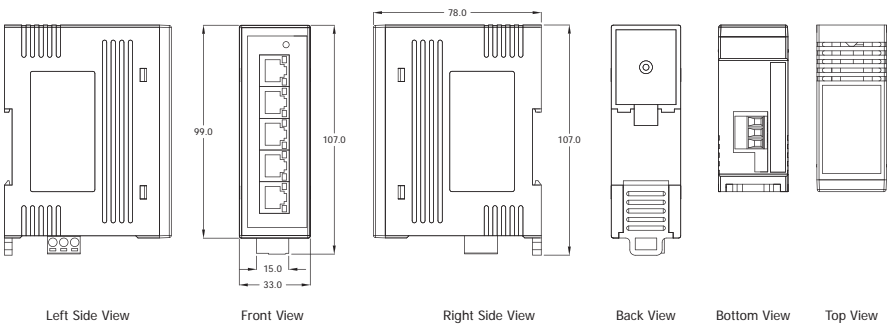

● Ordering Information

NS-205	Unmanaged 5-Port Industrial Ethernet Switch
NS-205 CR	Unmanaged 5-Port Industrial Ethernet Switch (RoHS)
NS-205A CR	Unmanaged 5-Port Industrial Ethernet Switch with Power Input +12 V _{DC} ~ +48 V _{DC} (RoHS)

● Accessories

GPSU06-6	24V/0.25A, 6 W Power Supply
KWM020-1824F	24V/0.75A, 18 W Power Supply
DIN-KA52F	24V/1.04A, 25 W Power Supply with DIN-Rail Mounting

NS-205G



Unmanaged 5-Port Industrial 10/100/1000 Base-T Ethernet Switch

3

Unmanaged Ethernet Switches

NS-205G

Highlight Information ▶▶▶

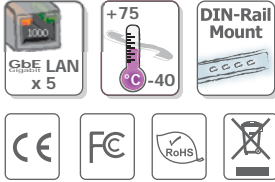

● Introduction

The NS-205G is 5-port unmanaged gigabit switches that support 10/100/1000 Base-T, with a 10/100/1000M auto negotiation feature and auto MDI/MDI-X function. It can connect 5 workstations and automatically switches the transmission speed (10 Mbps or 100 Mbps or 1000 Mbps) for corresponding connections.

That is an ideal solution for bandwidth-hungry applications (such as high resolution digital image transmission, video/audio file streaming/downloading, and server farm connectivity).

The flow control mechanism is also negotiated. There is link/data rate LEDs for each port to aid troubleshooting. Port connectors are shielded RJ-45.

Power Savings by Number of Connected Ports and Link Status: Computers do not require Internet access all the time; neither do switches utilize all ports at all times. When a computer or network equipment is shutdown, switches often remain on and continue to consume considerable amount of power. With Green Ethernet technology, NS-205G can automatically detect link status and reduce power usage of ports that are idle. Computers or any connecting parties set to standby mode (not power off), however, will not provide significant power savings.

Power Savings by Cable Length:

The Power Saving switches have the ability to analyze the length of any Ethernet cable connected to them for adjustment of power usage accordingly. Shorter lengths require less power.

● Features

- Power saving Technology
- Automatic MDI/MDI-X crossover for plug-and-play
- Each port supports 10/100 and 1000 Mbps speed auto negotiation
- Store-and-forward architecture
- 10 Gbps high performance memory bandwidth
- Full duplex IEEE 802.3x and half duplex backpressure flow control
- Power Inputs +10 V_{DC} ~ +30 V_{DC}
- Supports operating temperatures from -40 °C ~ +75 °C
- DIN-Rail

● Specifications

Technology	
Standards	IEEE 802.3, 802.3u, 802.3ab and 802.3x
Processing Type	Store & forward, wire speed switching
MAC Addresses	8192
Memory Bandwidth	10 Gbps
Frame Buffer Memory	1 Mbit
Jumbo Frames	9K for Speed 1000M
Flow Control	IEEE 802.3x flow control, back pressure flow control
Interface	
RJ-45 Ports	10/100/1000 Base-T auto negotiation speed, F/H duplex mode, and auto MDI/MDI-X connection
LED Indicators	Power, 10/100/1000M, Link/Act
Ethernet Isolation	1500 V _{rms} 1 minute
Frame Ground for EMS Protection	Yes
Cable	Ethernet: 2-pair UTP/STP Cat.3, 4, 5, EIA/TIA-568 100 Ω
	Fast Ethernet: 2-pair UTP/STP Cat. 5, EIA/TIA-568 100 Ω
	Gigabit Ethernet: 4-pair UTP/STP Cat.5, EIA/TIA-568 100 Ω
Power	
Input Voltage Range	+10 V _{DC} ~ +30 V _{DC} (Non-isolation)
Power Consumption	0.2 A @ 24 V _{DC} , +/-5% arrowed with 1000M Full duplex
Protection	Power reverse polarity protection
Frame Ground for EMS Protection	Yes
Connection	3-Pin Removable Terminal Block
Mechanical	
Casing	Plastic
Flammability	UL 94V-0
Dimensions	33 mm x 78 mm x 107 mm (W x L x H)
Installation	DIN-Rail
Environmental	
Operating Temperature	-40 °C ~ +75 °C
Storage Temperature	-40 °C ~ +85 °C
Ambient Relative Humidity	10% ~ 90% RH, non-condensing

LED Functions

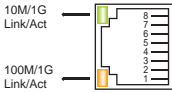

LED Indicator Functions

LED	Color	Description
Power	Red On	Power is On
	Red Off	Power is Off
Ethernet Port	Orange On	Link to 1000 Mbps
	Green On	
	Only Orange On	Link to 100 Mbps
	Only Green On	Link to 10 Mbps

RJ-45 Pin-Out

Pin#	Signal Name	Function
1	BI_DA+	Bi-directional pair +A
2	BI_DA-	Bi-directional pair -A
3	BI_DB+	Bi-directional pair +B
4	BI_DC+	Bi-directional pair +C
5	BI_DC-	Bi-directional pair -C
6	BI_DB-	Bi-directional pair -B
7	BI_DD+	Bi-directional pair +D
8	BI_DD-	Bi-directional pair -D

Power Saving Application

An automatic power savings when a specific port is in link down or standby operation.	An intelligent algorithm that actively determines the appropriate power level needed based on cable length.
up 60%	up 10%

Power Saving by Cable Length

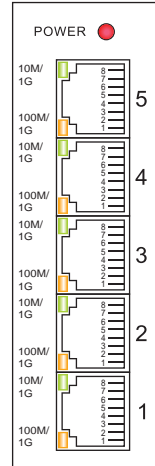
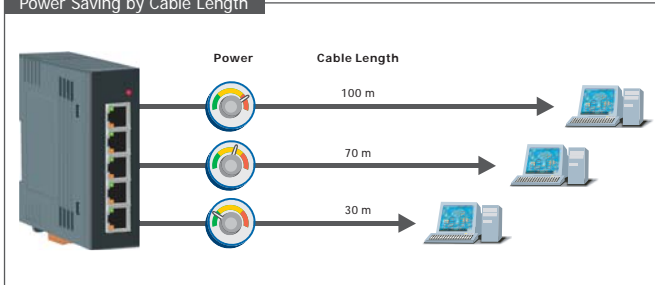

Pin Function for Terminal Block

External power supply is connected using the removable terminal block:

+Vs : Power input (+10 V_{DC} ~ +30 V_{DC}) and should be connected to the power supply (+)

GND: Ground and should be connected to the power supply (-)

F.G. : F.G. stands for Frame Ground (protective ground). It is optional. If you use this pin, it can reduce EMI radiation; improve EMI performance and ESD protection.

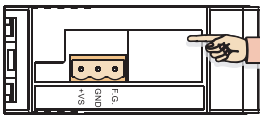

Checking Power

Since the NS-205G consumes 4.8 W Max., ensure that your power supply is able to meet this demand. The Input voltage range is +10 V_{DC} ~ +30 V_{DC}.

● Appearance

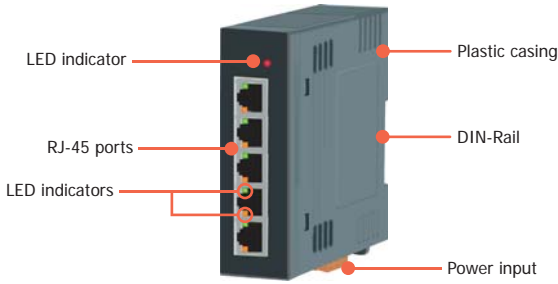

● Dimensions (Unit: mm)

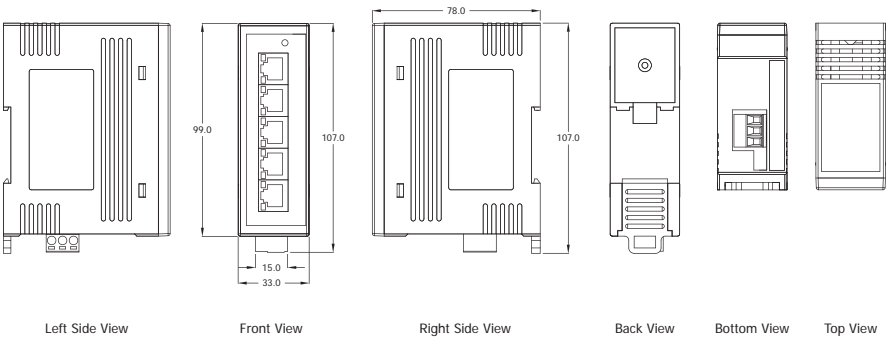

● Ordering Information

NS-205G CR	Unmanaged 5-Port Industrial 10/100/1000 Base-T Ethernet Switch (RoHS)
------------	---

● Accessories

GPSU06-6	24V/0.25A, 6 W Power Supply
KWM020-1824F	24V/0.75A, 18 W Power Supply
DIN-KA52F	24V/1.04A, 25 W Power Supply with DIN-Rail Mounting

NS-205PSE ★ NEW

Unmanaged Ethernet Switch with 4-PoE Port and 1 RJ-45 Uplink (RoHS)

3

Unmanaged Ethernet Switches

NS-205PSE

Highlight Information ▶▶▶▶

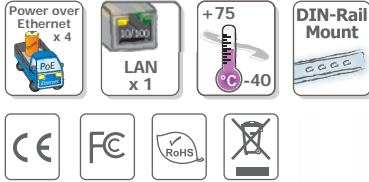

● Introduction

The NS-205PSE is a 5-Port unmanaged PoE (Power-over-Ethernet) Industrial Ethernet Switch, it supports 4-PoE Port which are classified as power source equipments (PSE). The NS-205PSE makes centralized power supply come true and provides up to 15.4 watts of power per port. The NS-205PSE can be used to power IEEE 802.3af compliant powered devices (PD) by Ethernet cable and eliminates the need for additional power wiring.

● Features

- Automatic MDI/MDI-X crossover for plug-and-play
- Each port supports both 10/100 Mbps speed auto negotiation
- Store-and-forward architecture
- Full duplex IEEE 802.3x and half duplex backpressure flow control
- 3.2 Gbps high performance memory bandwidth
- Power Inputs +46 V_{dc} ~ +55 V_{dc}
- Supports operating temperatures from -40 °C ~ +75 °C
- DIN-Rail
- IEEE 802.3af compliant PoE ports
 - 4-PoE Port with power sourcing equipment (PSE) operation
 - Auto-detection of PD (powered devices) and automatic power management over-temperature, over-current and over/under-voltage detection

● Specifications

Technology	
Standards	IEEE 802.3, 802.3u, 802.3x, 802.3af (Power-over-Ethernet)
Processing Type	Store & forward, wire speed switching
MAC Addresses	1024
Memory Bandwidth	3.2 Gbps
Frame Buffer Memory	512 Kbit
Flow Control	IEEE 802.3x flow control, back pressure flow control
Interface	
RJ-45 Ports	10/100 Base-TX auto negotiation speed, F/H duplex mode, and auto MDI/MDI-X connection
LED Indicators	Power, 10/100M, Link/Act
Ethernet Isolation	1500 V _{rms} 1 minute
Frame Ground for EMS Protection	Yes
Cable	Ethernet: 2-pair UTP/STP Cat.3,4,5, EIA/TIA-568 100 Ω
	Fast Ethernet: 2-pair UTP/STP Cat. 5, EIA/TIA-568 100 Ω
Power	
Input Voltage Range	+46 V _{DC} ~ +55 V _{DC} for PoE output
Power Consumption	1.3 A @ 48 V _{DC} , +/-5% arrowed with PoE
Protection	Power reverse polarity protection
Frame Ground for EMS Protection	Yes
Connection	3-Pin Removable Terminal Block
Mechanical	
Casing	Plastic
Flammability	UL 94V-0
Dimensions	33 mm x 107 mm x 99 mm (W x L x H)
Installation	DIN-Rail
Environmental	
Operating Temperature	-40 °C ~ +75 °C
Storage Temperature	-40 °C ~ +85 °C
Ambient Relative Humidity	10% ~ 90% RH, non-condensing

● LED Functions

LED Indicator Functions		
LED	Color	Description
Power	Red On	Power is On
	Red Off	Power is Off
Port 1 ~ Port 4	Orange On	Power Device is detected
	Green On	Link/Act
Port 5	Yellow On	Link to 100 Mbps
	Green On	Link/Act

● Pin Function for Terminal Block

External power supply is connected using the removable terminal block:

+Vs : Power input (+46 V_{DC} ~ +55 V_{DC}) and should be connected to the power supply (+)

GND: Ground and should be connected to the power supply (-)

F.G. : F.G. stands for Frame Ground (protective ground). It is optional. If you use this pin, it can reduce EMI radiation; improve EMI performance and ESD protection.

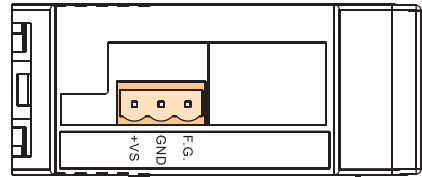

● Applications

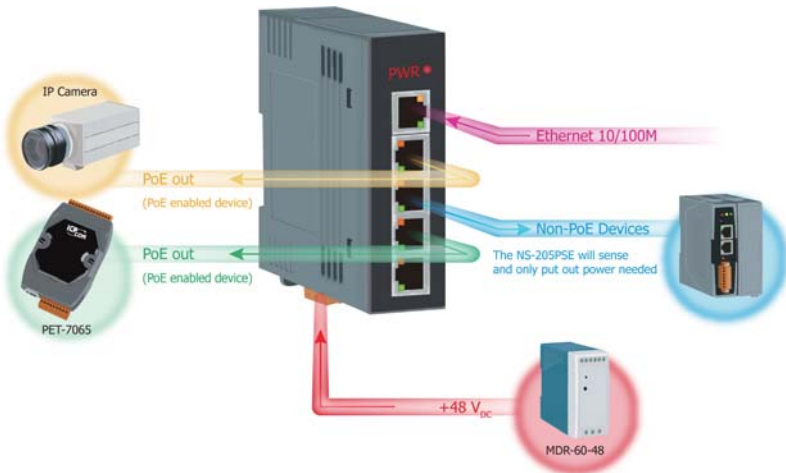

● Appearance

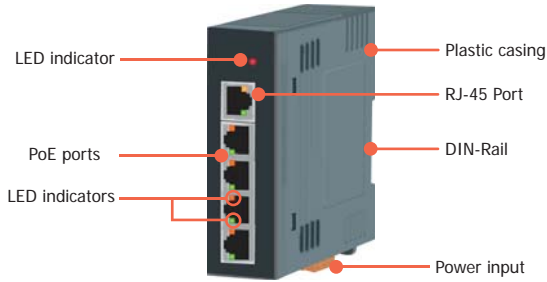

● Dimensions (Unit: mm)

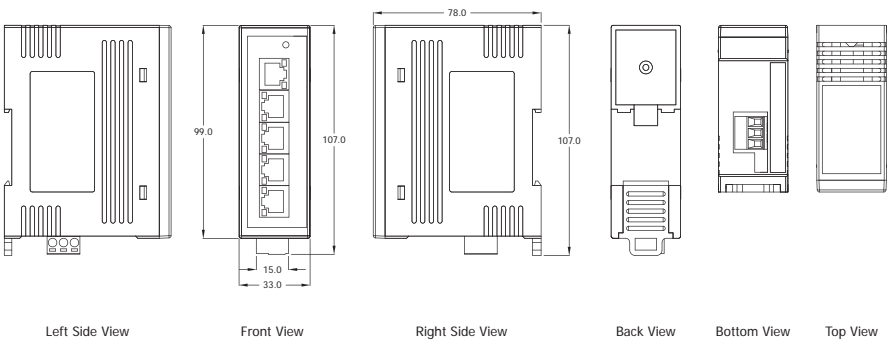

● Ordering Information

NS-205PSE CR	Unmanaged Ethernet Switch with 4-PoE Port and 1 RJ-45 Uplink (RoHS)
--------------	---

● Accessories

MDR-60-48	48V/1.25A, 60 W Power Supply with DIN-Rail Mounting
-----------	---

NS-205PSE-24V/NSM-205PSE-24V

5-Port 10/100 Mbps PoE (PSE) Ethernet Switch with 24 VDC Input



NS-205PSE-24V Series

NSM-205PSE-24V Series

Highlight Information ▶▶▶

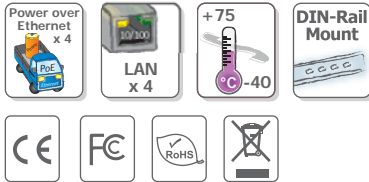

● Introduction

The NS-205PSE-24V/NSM-205PSE-24V is a 5-port unmanaged PoE (Power-over-Ethernet) Industrial Ethernet switch; it supports 4 PoE ports which are classified as power source equipments (PSE). The NS-205PSE-24V/NSM-205PSE-24V makes centralized power supply come true and provides up to 15.4 watts of power per PSE port.

The NS-205PSE-24V/NSM-205PSE-24 is designed with 24 V_{dc} to 48 V_{dc} boost for PoE application where 48 V_{dc} power supply is not available.

● Features

- Automatic MDI/MDI-X crossover for plug-and-play
- Each port supports both 10/100 Mbps speed auto negotiation
- Store-and-forward architecture
- Full duplex IEEE 802.3x and half duplex backpressure flow control
- 3.2 Gbps high performance memory bandwidth
- Power Inputs +18 V_{dc} ~ +32 V_{dc}
- Supports operating temperatures from -40 °C ~ +75 °C
- DIN-Rail
- IEEE 802.3af compliant PoE ports
 - 4-PoE Port with power sourcing equipment (PSE) operation Auto-detection of PD (powered devices) and automatic power management over-temperature, over-current and over/under-voltage detection

● Specifications

Models	NS-205PSE-24V	NSM-205PSE-24V
Technology		
Standards	IEEE 802.3, 802.3u, 802.3x, 802.3af (Power over Ethernet)	
Processing Type	Store & forward; wire speed switching	
MAC Addresses	1024	
Memory Bandwidth	3.2 Gbps	
Frame Buffer Memory	512 Kbit	
Flow Control	IEEE 802.3x flow control, back pressure flow control	
Interface		
RJ-45 Ports	10/100 Base-T(X) auto negotiation speed, F/H duplex mode, and auto MDI/MDI-X connection	
LED Indicators	Power, Link/Act, 10/100M, Power Device is detected	
Ethernet Isolation	1500 V _{rms} 1 minute	
+/-6 kV EMS Protection	Yes	
Power Input		
Input Voltage Range	+18 ~ +32 V _{DC} for PoE output	
Power Consumption	0.24 @ 24 V _{DC} without PD loading	
Protection	Power reverse polarity protection	
Frame Ground for EMS Protection	Yes	
Connection	3-Pin Removable Terminal Block	
PoE Output		
PoE Compliance	100% IEEE 802.3af compliant	
PoE Classification	PSE (Power Sourcing Equipment)	
PoE Voltage	+48 V _{DC} depending on power input	
PoE Power	Up to 15.4 watts per channel	
PoE Operation	Automatic detection and power management	
Mechanical		
Casing	Plastic (Flammability UL 94V-0)	Metal (IP30 Protection)
Dimensions (W x L x H)	31 mm x 157 mm x 113 mm	25 mm x 168 mm x 119 mm
Installation	DIN-Rail	
Environmental		
Operating Temperature	-40 °C ~ +75 °C	
Storage Temperature	-40 °C ~ +85 °C	
Ambient Relative Humidity	10% ~ 90% RH, non-condensing	

● LED Functions

LED Indicator Functions		
LED	Color	Description
Power	Red On	Power is On
	Red Off	Power is Off
Port 1 ~ Port 4	Orange On	Power Device is detected
	Green On	Link/Act
Port 5	Yellow On	Link to 100 Mbps
	Green On	Link/Act

● Pin Function for Terminal Block

External power supply is connected using the removable terminal block:

PWR : Power input (+18 V_{DC} ~ +32 V_{DC}) and should be connected to the power supply (+)

GND: Ground and should be connected to the power supply (-)

F.G. : F.G. stands for Frame Ground (protective ground). It is optional. If you use this pin, it can reduce EMI radiation; improve EMI performance and ESD protection.

● Applications

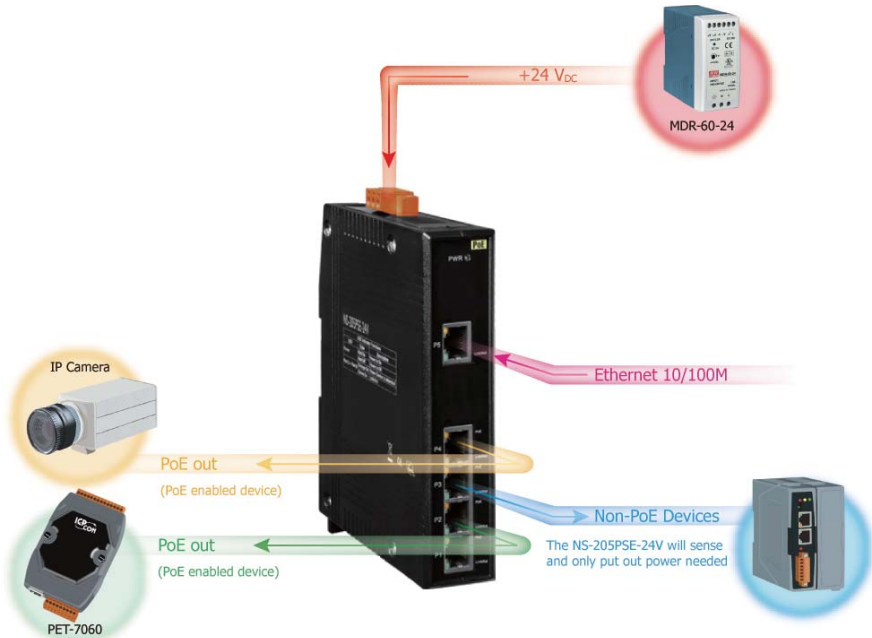

● Dimensions (Unit: mm)

NS-205PSE-24V Series

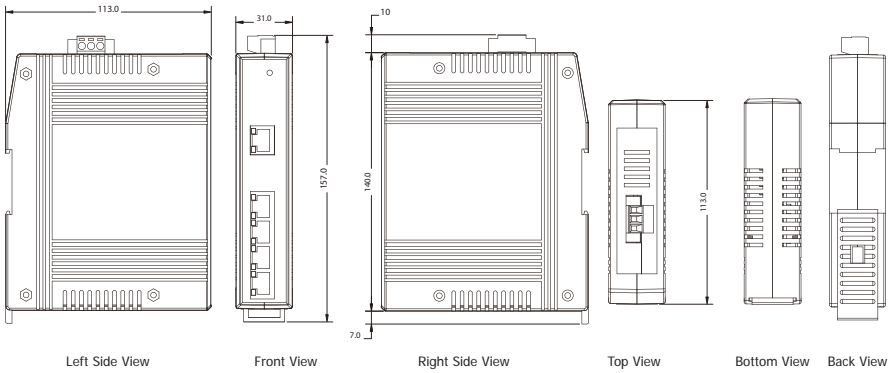

NSM-205PSE-24V Series

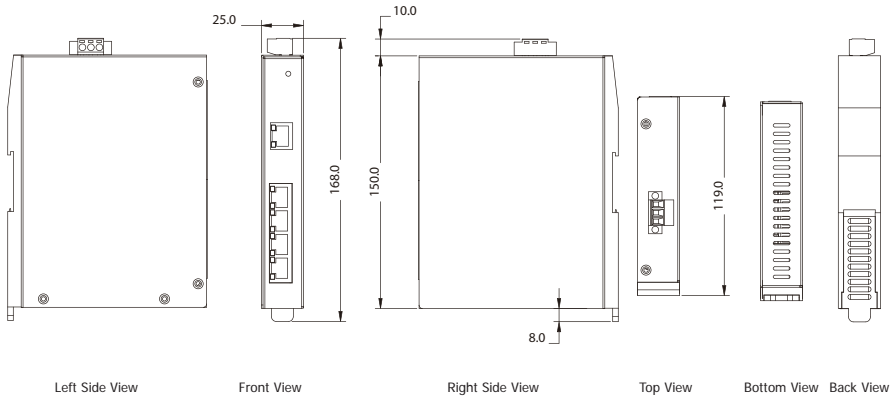

● Ordering Information

NS-205PSE-24V CR	Unmanaged 5-Port 10/100 Mbps PoE(PSE) Ethernet Switch; 24 VDC Input (RoHS)
NSM-205PSE-24V CR	Unmanaged 8-Port Industrial 10/100 Mbps PoE(PSE) Ethernet Switch with Metal Casing (RoHS)

● Accessories

MDR-60-24	24V/2.5A, 60 W Power Supply with DIN-Rail Mounting
MDR-20-24	24V/1.0A, 24 W Power Supply with DIN-Rail Mounting
DIN-KA52F	24V/1.04A, 25 W Power Supply with DIN-Rail Mounting

NS-208/NSM-108 Series

Unmanaged 8-Port Industrial 10/100 Base-TX Ethernet Switch

3

Unmanaged Ethernet Switches

NS-208/NSM-108 Series

Highlight Information ▶▶▶

NS-208/NSM-108 Series



For NSM-108 Series



For NS-208 Series



NSM-108 Series

NS-208 Series



● Introduction

The NS-208/NSM-108 series has 8 Ethernet Switching ports that support 10/100 Base-TX, with a 10/100M auto negotiation feature and auto MDI/MDI-X function. It can connect 8 workstations and automatically switches the transmission speed (10 Mbps or 100 Mbps) for corresponding connections.

The flow control mechanism is also negotiated. There is link/data rate LEDs for each port to aid troubleshooting. Port connectors are shielded RJ-45.

● Features

- Automatic MDI/MDI-X crossover for plug-and-play
- Each port supports both 10/100 Mbps speed auto negotiation
- Store-and-forward architecture
- Full duplex IEEE 802.3x and half duplex backpressure flow control
- 2 Gbps high performance memory bandwidth
- Power Inputs +10 V_{DC} ~ +30 V_{DC}
- Supports operating temperatures from -40 °C ~ +75 °C
- DIN-Rail

● Specifications

Models	NS-208	NSM-108
Technology		
Standards	IEEE 802.3, 802.3u, 802.3x	
Processing Type	Store & forward, wire speed switching	
MAC Addresses	1024	
Memory Bandwidth	2 Gbps	
Frame Buffer Memory	512 Kbit	
Flow Control	IEEE 802.3x flow control, back pressure flow control	
Interface		
RJ-45 Ports	10/100 Base-TX auto negotiation speed, F/H duplex mode, and auto MDI/MDI-X connection	
LED Indicators	Power, 10/100M, Link/Act	
Ethernet Isolation	1500 V _{rms} 1 minute	
Frame Ground for EMS Protection	Yes	
Cable	Ethernet: 2-pair UTP/STP Cat.3, 4, 5, EIA/TIA-568 100 Ω	
	Fast Ethernet: 2-pair UTP/STP Cat. 5, EIA/TIA-568 100 Ω	
Power		
Input Voltage Range	+10 V _{DC} ~ +30 V _{DC} (Non-isolation)	
Power Consumption	0.15 A @ 24 V _{DC} , +/-5% arrowed with 10M Full duplex	
	0.09 A @ 24 V _{DC} , +/-5% arrowed with 100M Full duplex	
Protection	Power reverse polarity protection	
Frame Ground for EMS Protection	Yes	
Connection	5-Pin Removable Terminal Block	5-Pin Removable Terminal Block
Mechanical		
Casing	Plastic (Flammability UL 94V-0)	Metal (IP20 Protection)
Dimensions (W x L x H)	64 mm x 98 mm x 118 mm	73 mm x 102 mm x 132 mm
Installation	DIN-Rail	DIN-Rail or Wall Mounting
Environmental		
Operating Temperature	-40 °C ~ +75 °C	
Storage Temperature	-40 °C ~ +85 °C	
Ambient Relative Humidity	10% ~ 90% RH, non-condensing	

LED Functions

LED Indicator Functions

LED	Color	Description
Power	Red On	Power is On
	Red Off	Power is Off
Ethernet Port	Green On	Link/Act
	Green Off	Not Networking
	Yellow On	Link to 100 Mbps
	Yellow Off	Link to 10 Mbps

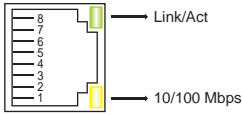

RJ-45 Pin-Out

Pin#	Signal Name	Function
1	TD+	Transmit Data
2	TD-	Transmit Data
3	RD+	Receive Data
4	NC	No Connection
5	NC	No Connection
6	RD-	Receive Data
7	NC	No Connection
8	NC	No Connection

Pin Function for Terminal Block

External power supply is connected using the removable terminal block:

+Vs : Power input +10 V_{DC} ~ +30 V_{DC}

GND : Ground

F.G. : F.G. stands for Frame Ground (protective ground). It is optional. If you use this pin, it can reduce EMI radiation; improve EMI performance and ESD protection.

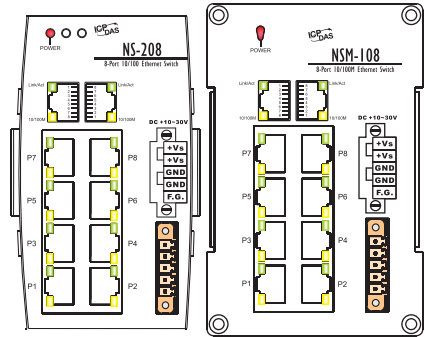

Appearance

NSM-108 Series

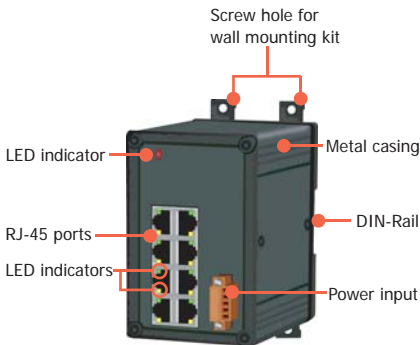

NS-208 Series

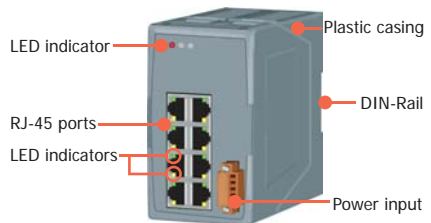

● Dimensions (Unit: mm)

NSM-108 Series

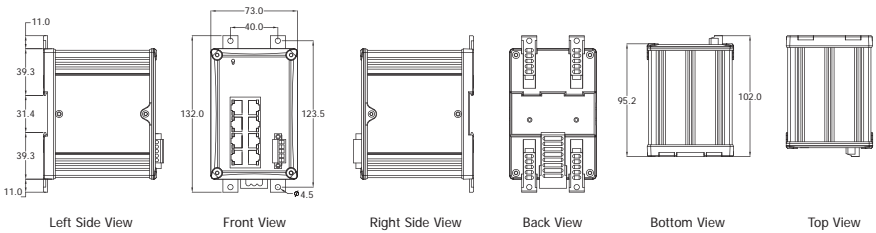

NS-208 Series

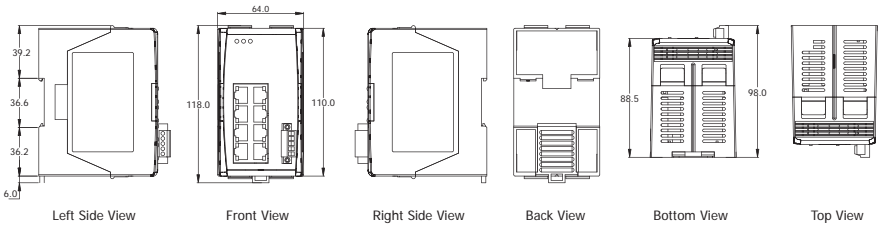

● Ordering Information

NS-208 CR	Unmanaged 8-Port Industrial 10/100 Base-TX Ethernet Switch with Power Input +10 V _{DC} ~ +30 V _{DC} (RoHS)
NSM-108 CR	Unmanaged 8-Port Industrial 10/100 Base-TX Ethernet Switch with Power Input +10 V _{DC} ~ +30 V _{DC} , metal casing (RoHS)
NS-208A CR	Unmanaged 8-Port Industrial 10/100 Base-TX Ethernet Switch with Power Input +12 V _{DC} ~ +48 V _{DC} (RoHS)
NSM-108A CR	Unmanaged 8-Port Industrial 10/100 Base-TX Ethernet Switch with Power Input +12 V _{DC} ~ +48 V _{DC} , metal casing (RoHS)

● Accessories

GPSU06-6	24V/0.25A, 6 W Power Supply
KWM020-1824F	24V/0.75A, 18 W Power Supply
DIN-KA52F	24V/1.04A, 25 W Power Supply with DIN-Rail Mounting

NS-208G/NSM-208G Series

Unmanaged 8-Port Industrial 10/100/1000 Base-T Ethernet Switch

3

Unmanaged Ethernet Switches

NS-208G/NSM-208G Series

Highlight Information ▶▶▶

NS-208G/NSM-208G Series

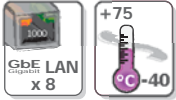

For NSM-208G Series



For NS-208G Series



NSM-208G Series



NS-208G Series



● Introduction

The NS-208G/NSM-208G series has 8 Ethernet Switching ports that support 10/100/1000 Base-T, with a 10/100/1000M auto negotiation feature and auto MDI/MDI-X function. It can connect 8 workstations and automatically switches the transmission speed (10 Mbps or 100 Mbps or 1000 Mbps) for corresponding connections.

The flow control mechanism is also negotiated. There is link/data rate LEDs for each port to aid troubleshooting. Port connectors are shielded RJ-45.

● Features

- Automatic MDI/MDI-X crossover for plug-and-play
- Each port supports 10/100 and 1000 Mbps speed auto negotiation
- Store-and-forward architecture
- Full duplex IEEE 802.3x and half duplex backpressure flow control
- 16 Gbps high performance memory bandwidth
- Power Inputs +10 V_{DC} ~ +30 V_{DC}
- Supports operating temperatures from -40 °C ~ +75 °C
- DIN-Rail

● Specifications

Models	NS-208G	NSM-208G
Technology		
Standards	IEEE 802.3, 802.3u, 802.3ab and 802.3x	
Processing Type	Store & forward, wire speed switching	
MAC Addresses	8192	
Memory Bandwidth	16 Gbps	
Frame Buffer Memory	1 Mbit	
Jumbo Frames	9K for Speed 1000M	
Flow Control	IEEE 802.3x flow control, back pressure flow control	
Interface		
RJ-45 Ports	10/100/1000 Base-T auto negotiation speed, F/H duplex mode, and auto MDI/MDI-X connection	
LED Indicators	Power, 10/100/1000M, Link/Act	
Ethernet Isolation	1500 V _{rms} 1 minute	
Frame Ground for EMS Protection	Yes	
Cable	Ethernet: 2-pair UTP/STP Cat.3, 4, 5, EIA/TIA-568 100 Ω	
	Fast Ethernet: 2-pair UTP/STP Cat. 5, EIA/TIA-568 100 Ω	
	Gigabit Ethernet: 4-pair UTP/STP Cat.5, EIA/TIA-568 100 Ω	
Power		
Input Voltage Range	+10 V _{DC} ~ +30 V _{DC} (Non-isolation)	
Power Consumption	0.3 A @ 24 V _{DC} , +/-5% arrowed with 1000M Full duplex	
Protection	Power reverse polarity protection	
Frame Ground for EMS Protection	Yes	
Connection	5-Pin Removable Terminal Block	
Mechanical		
Casing	Plastic (Flammability UL 94V-0)	Metal (IP20 Protection)
Dimensions (W x L x H)	64 mm x 98 mm x 118 mm	73 mm x 102 mm x 132 mm
Installation	DIN-Rail	DIN-Rail or Wall Mounting
Environmental		
Operating Temperature	-40 °C ~ +75 °C	
Storage Temperature	-40 °C ~ +75 °C	
Ambient Relative Humidity	10% ~ 90% RH, non-condensing	

LED Functions

LED Indicator Functions

LED	Color	Description
Power	Red On	Power is On
	Red Off	Power is Off
Ethernet Port	Orange On	Link to 1000 Mbps
	Green On	
	Only Orange On	Link to 100 Mbps
	Only Green On	Link to 10 Mbps

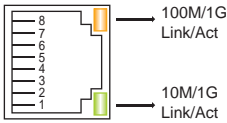

RJ-45 Pin-Out

Pin#	Signal Name	Function
1	BI_DA+	Bi-directional pair +A
2	BI_DA-	Bi-directional pair -A
3	BI_DB+	Bi-directional pair +B
4	BI_DC+	Bi-directional pair +C
5	BI_DC-	Bi-directional pair -C
6	BI_DB-	Bi-directional pair -B
7	BI_DD+	Bi-directional pair +D
8	BI_DD-	Bi-directional pair -D

Pin Function for Terminal Block

External power supply is connected using the removable terminal block:

+Vs : Power input (+10 V_{dc} ~ +30 V_{dc}) and should be connected to the power supply (+)

GND: Ground and should be connected to the power supply (-)

F.G. : F.G. stands for Frame Ground (protective ground). It is optional. If you use this pin, it can reduce EMI radiation; improve EMI performance and ESD protection.

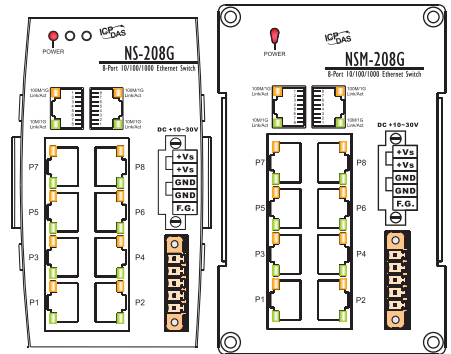

Appearance

NSM-208G Series

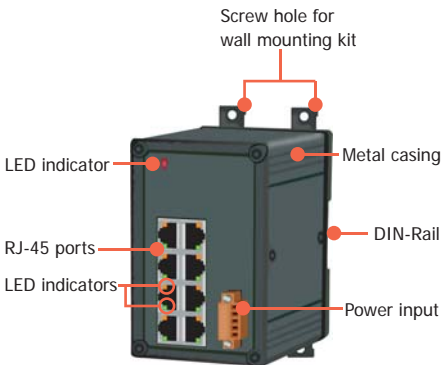

NS-208G Series

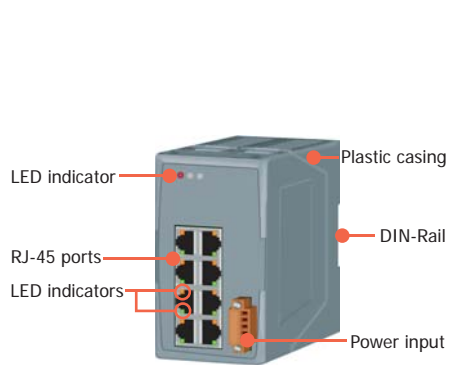

● Dimensions (Unit: mm)

NSM-208G Series

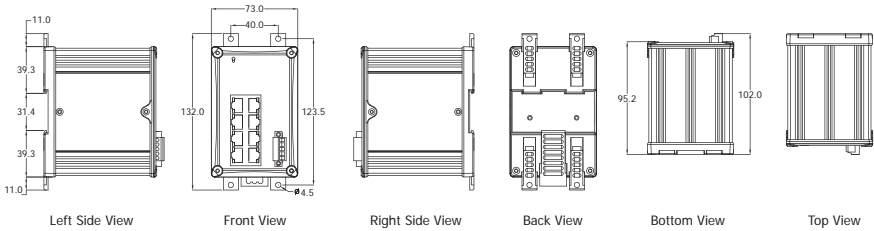

NS-208G Series

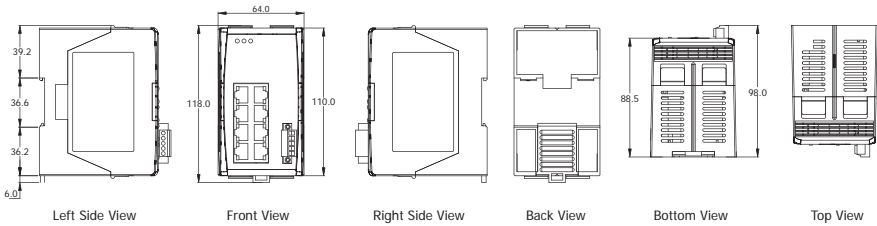

● Ordering Information

NS-208G CR	Unmanaged 8-Port 10/100/1000 Base-T Ethernet Switch with Power Input +10 V _{DC} ~ +30 V _{DC} (RoHS)
NSM-208G CR	Unmanaged 8-Port 10/100/1000 Base-T Ethernet Switch with Power Input +10 V _{DC} ~ +30 V _{DC} , metal casing (RoHS)
NS-208AG CR	Unmanaged 8-Port 10/100/1000 Base-T Ethernet Switch with Power Input +12 V _{DC} ~ +48 V _{DC} (RoHS)
NSM-208AG CR	Unmanaged 8-Port 10/100/1000 Base-T Ethernet Switch with Power Input +12 V _{DC} ~ +48 V _{DC} , metal casing (RoHS)

● Accessories

KWM020-1824F	24V/0.75A, 18 W Power Supply
DIN-KA52F	24V/1.04A, 25 W Power Supply with DIN-Rail Mounting
MDR-20-24	24V/1A, 24 W Power Supply with DIN-Rail Mounting

NS-208PSE/NSM-208PSE



8-Port Industrial 10/100 Mbps PoE(PSE) Ethernet Switch (RoHS)

3

Unmanaged Ethernet Switches

NS-208PSE/NSM-208PSE

Highlight Information ▶▶▶

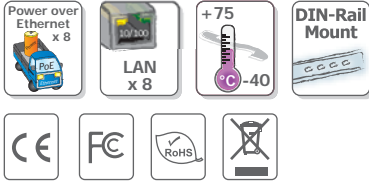

NS-208PSE Series

NSM-208PSE Series



● Introduction

The NS-208PSE/NSM-208PSE is an 8-port unmanaged PoE (Power-over-Ethernet) Industrial Ethernet switch, it supports 8 PoE ports which are classified as power source equipments (PSE). The NS-208PSE/NSM-208PSE makes centralized power supply come true and provides up to 15.4 watts of power per port. The NS-208PSE/NSM-208PSE can be used to power IEEE802.3af compliant powered devices (PD) by Ethernet cable and eliminates the need for additional power wiring.

● Features

- Automatic MDI/MDI-X crossover for plug-and-play
- Each port supports both 10/100Mbps speed auto negotiation
- Store-and-forward architecture
- Full duplex IEEE 802.3x and half duplex backpressure flow control
- 8 PoE ports with Power Sourcing Equipment (PSE) operation
- Auto-detection of PD (powered devices) and automatic power management
- Over-temperature, over-current and over/under-voltage detection
- Supports operating temperatures from -40 – +75°C
- DIN-Rail
- "-R" stands for products with conformal coating protection

● Specifications

Models	NS-208PSE Series	NSM-208PSE Series
Technology		
Standards	IEEE 802.3, 802.3u, 802.3x, 802.3af (Power over Ethernet)	
Processing Type	Store & forward, wire speed switching	
MAC Addresses	1024	
Memory Bandwidth	3.2 Gbps	
Frame Buffer Memory	512 Kbit	
Flow Control	IEEE 802.3x flow control, back pressure flow control	
Interface		
RJ-45 Ports	10/100 Base-T(X) auto negotiation speed, F/H duplex mode, and auto MDI/MDI-X connection	
LED Indicators	Power, Link/Act, Power Device is detected	
Ethernet Isolation	1500 V _{rms} 1 minute	
+/-6 kV EMS Protection	Yes	
Power Input		
Input Voltage Range	+46 ~ +55 V _{DC} for PoE output	
Power Consumption	0.12 A @ 48 V _{DC} with PoE Off	
Protection	Power reverse polarity protection	
Frame Ground for EMS Protection	Yes	
Connection	3-Pin Removable Terminal Block	
PoE Output		
PoE Compliance	100% IEEE 802.3af compliant	
PoE Classification	PSE (Power Sourcing Equipment)	
PoE Voltage	+46 ~ +55 V _{DC} depending on power input	
PoE Power	Up to 15.4 watts per channel	
PoE Operation	Automatic detection and power management	
Mechanical		
Casing	Plastic (Flammability UL 94V-0)	Metal (IP30 Protection)
Dimensions (W x L x H)	31 mm x 157 mm x 113 mm	25 mm x 168 mm x 119 mm
Installation	DIN-Rail	
Environmental		
Operating Temperature	-40 °C ~ +75 °C	
Storage Temperature	-40 °C ~ +85 °C	
Ambient Relative Humidity	10% ~ 90% RH, non-condensing	

● LED Functions

LED Indicator Functions		
LED	Color	Description
Power	Red On	Power is On
	Red Off	Power is Off
Port 1 ~ Port 8	Orange On	Power Device is detected
	Green On	Link/Act

● Pin Function for Terminal Block

External power supply is connected using the removable terminal block:

PWR : Power input (+45 ~ +55 VDC) and should be connected to the power supply (+)

GND: Ground and should be connected to the power supply (-)

F.G. : F.G. stands for Frame Ground (protective ground). It is optional. If you use this pin, it can reduce EMI radiation; improve EMI performance and ESD protection.

● Applications

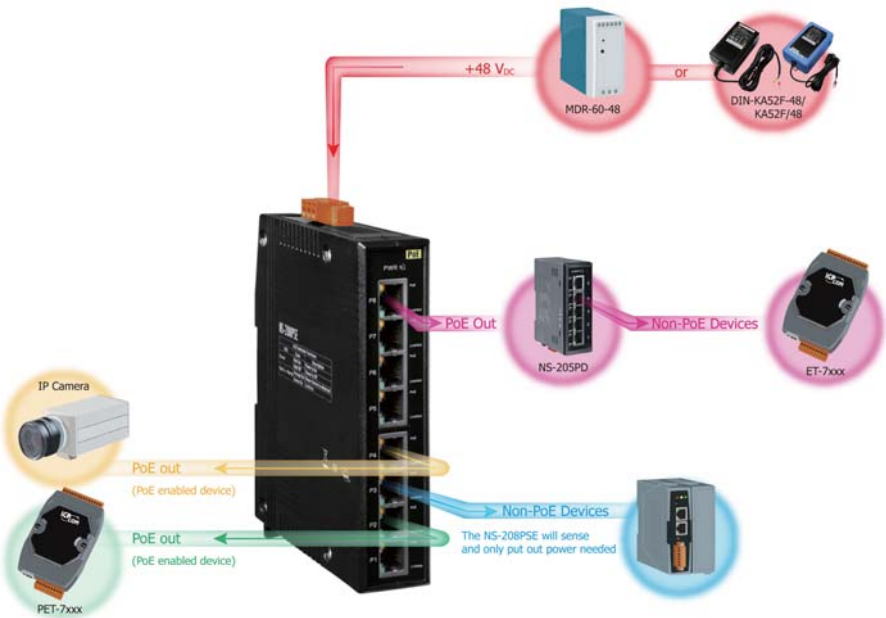

● Dimensions (Unit: mm)

NS-208PSE Series

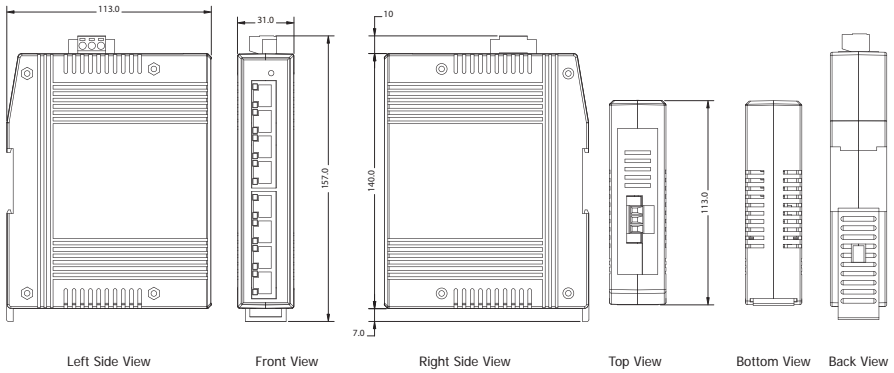

NSM-208PSE Series

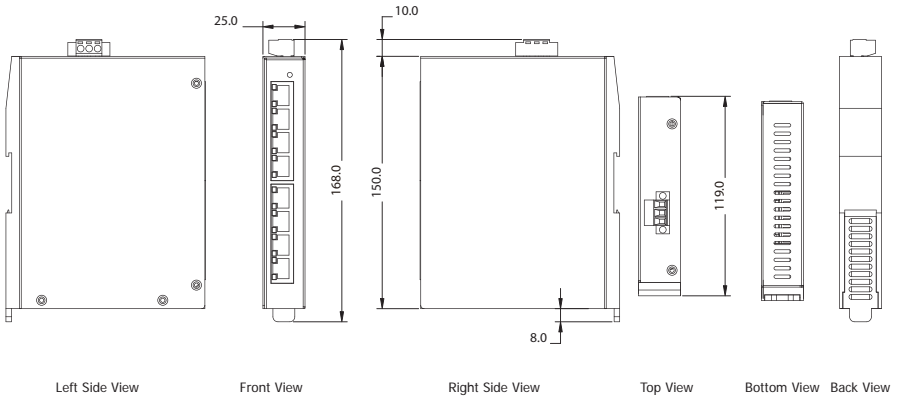

● Ordering Information

NS-208PSE CR	Unmanaged 8-Port Industrial 10/100 Mbps PoE(PSE) Ethernet Switch (RoHS)
NS-208PSE-R CR	NS-208PSE with Conformal coating protection (RoHS)
NSM-208PSE CR	Unmanaged 8-Port Industrial 10/100 Mbps PoE(PSE) Ethernet Switch with Metal Casing (RoHS)
NSM-208PSE-R CR	NSM-208PSE with Conformal coating protection (RoHS)

● Accessories

MDR-60-48	48V/1.25A, 60 W Power Supply with DIN-Rail Mounting
DIN-KA52F-48	48V/0.52A, 25 W Power Supply with DIN-Rail Mounting
KA52F-48	48V/0.52A, 25 W Power Supply

NS-208PSE-4/NSM-208PSE-4 NEW

8-Port Industrial 10/100 Mbps Ethernet with 4-PoE (PSE) Switch (RoHS)

3

Unmanaged Ethernet Switches

NS-208PSE-4/NSM-208PSE-4

Highlight Information ▶▶▶

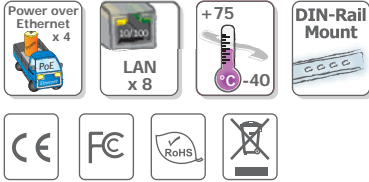

NS-208PSE-4 Series

NSM-208PSE-4 Series



● Introduction

The NS-208PSE-4/NSM-208PSE-4 is an 8-port unmanaged Ethernet with 4-PoE (Power-over-Ethernet) switch, it supports 4-PoE port which are classified as power source equipments (PSE). The NS-208PSE-4/NSM-208PSE-4 makes centralized power supply come true and provides up to 15.4 watts of power per port. The NS-208PSE-4/NSM-208PSE-4 can be used to power IEEE802.3af compliant powered devices (PD) by Ethernet cable and eliminates the need for additional power wiring.

● Features

- Automatic MDI/MDI-X crossover for plug-and-play
- Each port supports both 10/100Mbps speed auto negotiation
- Store-and-forward architecture
- Full duplex IEEE 802.3x and half duplex backpressure flow control
- 4 PoE ports with Power Sourcing Equipment (PSE) operation
- Auto-detection of PD (powered devices) and automatic power management
- Over-temperature, over-current and over/under-voltage detection
- Supports operating temperatures from -40 – +75°C
- DIN-Rail

● Specifications

Models	NS-208PSE Series	NSM-208PSE Series
Technology		
Standards	IEEE 802.3, 802.3u, 802.3x, 802.3af (Power over Ethernet)	
Processing Type	Store & forward, wire speed switching	
MAC Addresses	1024	
Memory Bandwidth	3.2 Gbps	
Frame Buffer Memory	512 Kbit	
Flow Control	IEEE 802.3x flow control, back pressure flow control	
Interface		
RJ-45 Ports	10/100 Base-T(X) auto negotiation speed, F/H duplex mode, and auto MDI/MDI-X connection	
LED Indicators	Power, Link/Act, Power Device is detected	
Ethernet Isolation	1500 V _{rms} 1 minute	
+/-6 kV EMS Protection	Yes	
Power Input		
Input Voltage Range	+46 ~ +55 V _{DC} for PoE output	
Power Consumption	0.12 A @ 48 V _{DC} with PoE Off	
Protection	Power reverse polarity protection	
Frame Ground for EMS Protection	Yes	
Connection	3-Pin Removable Terminal Block	
PoE Output		
PoE Compliance	100% IEEE 802.3af compliant	
PoE Classification	PSE (Power Sourcing Equipment)	
PoE Voltage	+46 ~ +55 V _{DC} depending on power input	
PoE Power	Up to 15.4 watts per channel	
PoE Operation	Automatic detection and power management	
Mechanical		
Casing	Plastic (Flammability UL 94V-0)	Metal (IP30 Protection)
Dimensions (W x L x H)	31 mm x 157 mm x 113 mm	25 mm x 168 mm x 119 mm
Installation	DIN-Rail	
Environmental		
Operating Temperature	-40 °C ~ +75 °C	
Storage Temperature	-40 °C ~ +85 °C	
Ambient Relative Humidity	10% ~ 90% RH, non-condensing	

● LED Functions

LED Indicator Functions		
LED	Color	Description
Power	Red On	Power is On
	Red Off	Power is Off
Port 1 ~ Port 4	Orange On	Power Device is detected
Port 1 ~ Port 8	Green On	Link/Act

● Pin Function for Terminal Block

External power supply is connected using the removable terminal block:

PWR : Power input (+45 ~ +55 VDC) and should be connected to the power supply (+)

GND: Ground and should be connected to the power supply (-)

F.G. : F.G. stands for Frame Ground (protective ground). It is optional. If you use this pin, it can reduce EMI radiation; improve EMI performance and ESD protection.

● Applications

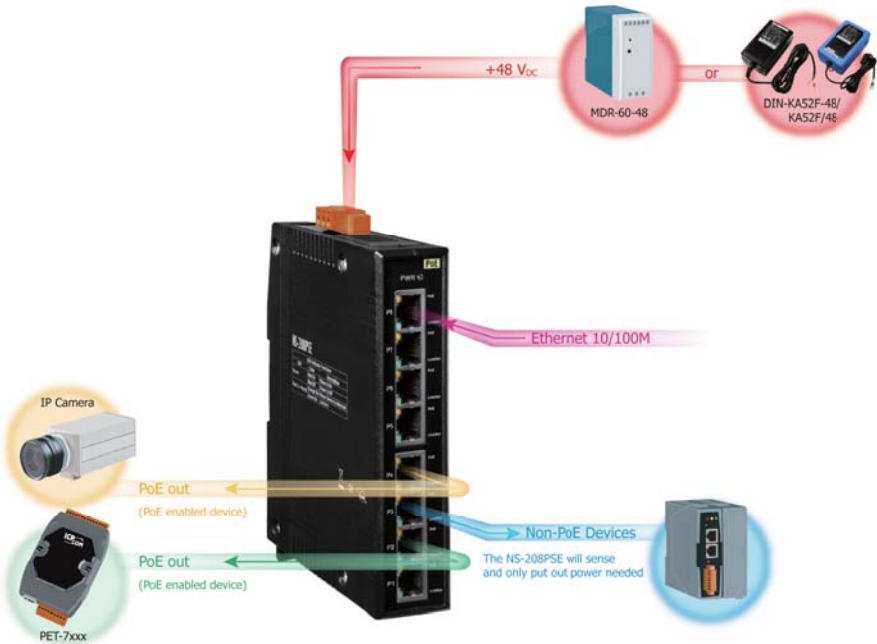

● Dimensions (Unit: mm)

NS-208PSE Series

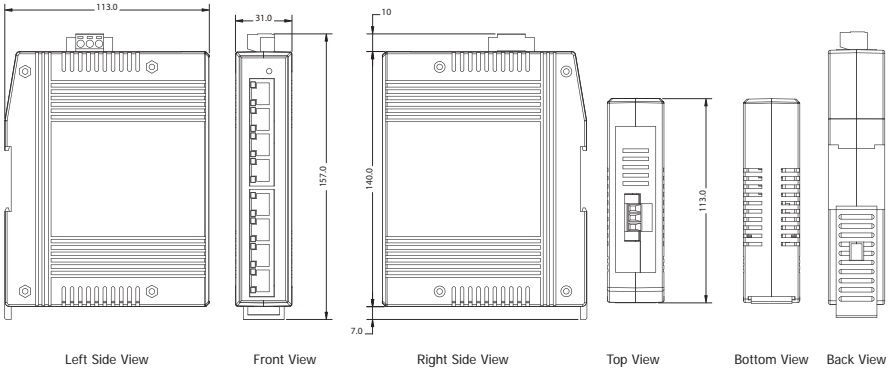

NSM-208PSE Series

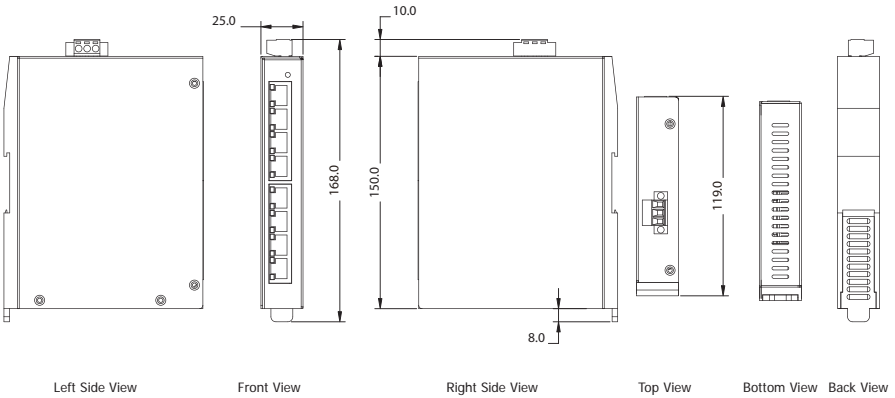

● Ordering Information

NS-208PSE-4 CR	8-Port Industrial 10/100 Mbps Ethernet with 4-PoE (PSE) Switch (RoHS)
NSM-208PSE-4 CR	8-Port Industrial 10/100 Mbps Ethernet with 4-PoE (PSE) Switch; Metal Casing (RoHS)

● Accessories

MDR-60-48	48V/1.25A, 60 W Power Supply with DIN-Rail Mounting
DIN-KA52F-48	48V/0.52A, 25 W Power Supply with DIN-Rail Mounting
KA52F-48	48V/0.52A, 25 W Power Supply

NS-205F/NSM-205F Series

Unmanaged 4-Port Industrial 10/100 Base-TX with 100 Base-FX Fiber Switch

3

Unmanaged Ethernet Switches

NS-205F/NSM-205F Series

Highlight Information ▶▶▶

NS-205F/NSM-205F Series



For NSM-205F Series



For NS-205F Series



NSM-205F Series



NS-205F Series



● Introduction

The NS-205F/NSM-205F series is a Unmanaged 4-Port Industrial Ethernet (10/100 Base-TX) to Fiber Port (100 Base-FX) switch that secures data transmission by using fiber optic transmission to provide immunity from EMI/RFI interference. It is used Ethernet for transmitting a signal up to 40 km, and is the perfect solution for applications where transmission must be protected from electrical exposure, surges, lightning or chemical corrosion.

The Ethernet supports 10/100M auto negotiation feature and auto MDI/MDI-X function.

● Features

- Automatic MDI/MDI-X crossover for plug-and-play
- Each port supports both 10/100 Mbps speed auto negotiation
- Store-and-forward architecture
- Full duplex IEEE 802.3x and half duplex backpressure flow control
- 3.2 Gbps high performance memory bandwidth
- Frame buffer memory: 512 Kbit
- Integrated look-up engine with dedicated 1024 unicast MAC addresses
- Supports +10 V_{DC} ~ +30 V_{DC}
- Supports operating temperatures from 0 °C ~ +70 °C

● Specifications

Models	NS-205F Series	NSM-205F Series
Technology		
Standards	IEEE 802.3, 802.3u, 802.3x	
Processing Type	Store & forward, wire speed switching	
MAC Addresses	1024	
Memory Bandwidth	3.2 Gbps	
Frame Buffer Memory	512 Kbit	
Flow Control	IEEE 802.3x flow control, back pressure flow control	
Interface		
RJ-45 Ports	10/100 Base-TX auto negotiation speed, F/H duplex mode, and auto MDI/MDI-X connection	
Fiber Optics Port	100 Base-FX	
LED Indicators	10/100M, Link/Act, Full duplex/Half duplex (Fiber Port)	
Ethernet Isolation	1500 V _{rms} 1 minute	
Frame Ground for EMS Protection	Yes	
Multi Mode	Multi Mode Fiber Cables: 50/125, 62.5/125 or 100/140 μm	
	Distance: 2 km, (62.5/125 μm recommended) for full duplex	
	Wavelength: 1300 or 1310 nm	
	Min. TX Output: -20 dBm	
	Max. TX Output: -14 dBm	
Single Mode	Single Mode Fiber Cables: 8.3/125, 8.7/125, 9/125 or 10/125 μm	
	Distance: 15 km, (9/125 μm recommended) for full duplex	
	Wavelength: 1300 or 1310 nm	
	Min. TX Output: -15 dBm	
	Max. TX Output: -8 dBm	
Ethernet Transmission Distance	Ethernet: 2-pair UTP/STP Cat.3, 4, 5, EIA/TIA-568 100 Ω	
	Fast Ethernet: 2-pair UTP/STP Cat. 5, EIA/TIA-568 100 Ω	
Power		
Input Voltage Range	+10 V _{DC} ~ +30 V _{DC} (Non-isolation)	+10 V _{DC} ~ +30 V _{DC} (Non-isolation) Redundant Inputs
Power Consumption	0.14 A @ 24 V _{DC} , +/-5% arrowed with 100M Full duplex	
LED Indicator	Yes	
Protection	Power reverse polarity protection	
Frame Ground for EMS Protection	Yes	
Mechanical		
Casing	Plastic (Flammability UL 94V-0)	Metal (IP20 Protection)
Dimensions (W x L x H)	64 mm x 101 mm x 118 mm	73 mm x 105 mm x 132 mm
Installation	DIN-Rail	DIN-Rail or Wall Mounting
Environmental		
Operating Temperature	0 °C ~ +70 °C	
Storage Temperature	-20 °C ~ +85 °C	
Ambient Relative Humidity	10% ~ 90% RH, non-condensing	

LED Functions

NSM-205F Series LED Indicator Functions

LED	Color	Description
PWR_OK	Red On	Core Power is OK
	Red Off	Core Power is Off
Full for P0	Yellow On	Full Duplex
	Yellow Off	Half Duplex
Link for P0	Green On	Link/Act
	Green Off	Not Networking
Ethernet Port (P1 ~ P4)	Yellow On	Link/Act
	Yellow Off	Not Networking
	Green On	Link to 100 Mbps
	Green Off	Link to 10 Mbps
PWR2	Green On	Power is being supplied to power input PWR2
	Green Off	Power is not being supplied to power input PWR2
PWR1	Yellow On	Power is being supplied to power input PWR1
FAULT	Yellow Off	Power is not being supplied to power input PWR1
	Red On	Power is not being supplied to power input PWR1 and PWR2
	Red Off	Power is being supplied to power input PWR1 and PWR2

Redundant Power Inputs

Both power inputs can be connected simultaneously to live DC power sources. If one power source fails, the other live source acts as a backup, and automatically supplies all of NSM-205F series power needs.

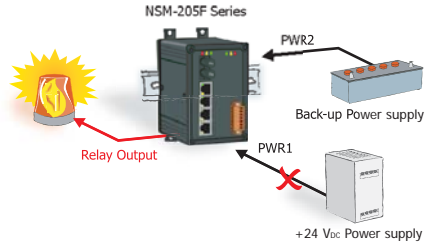

Appearance

NSM-205F Series

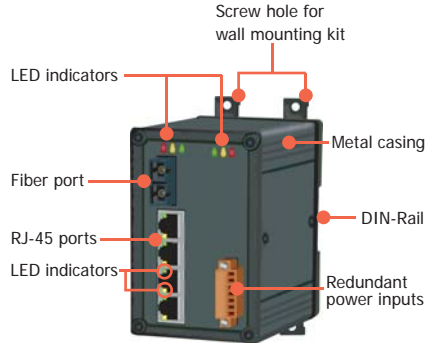
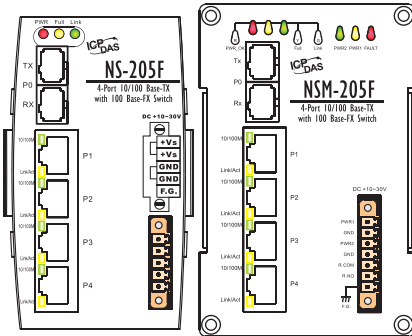

NS-205F Series

NS-205F Series LED Indicator Functions

LED	Color	Description
Power	Red On	Power is On
	Red Off	Power is Off
	Yellow On	Full Duplex Mode
Fiber Port (P0)	Yellow Off	Half Duplex Mode
	Green On	Link/Act
	Green Off	Not Networking
Ethernet Port (P1 ~ P4)	Yellow On	Link/Act
	Yellow Off	Not Networking
	Green On	Link to 100 Mbps
	Green Off	Link to 10 Mbps

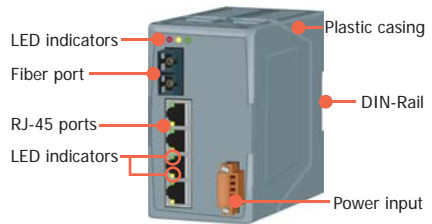

● Dimensions (Unit: mm)

NSM-205F Series

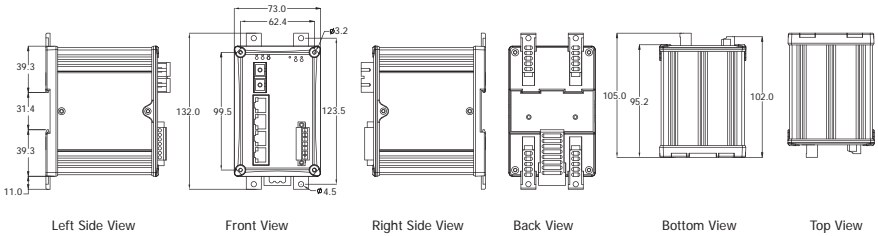

NS-205F Series

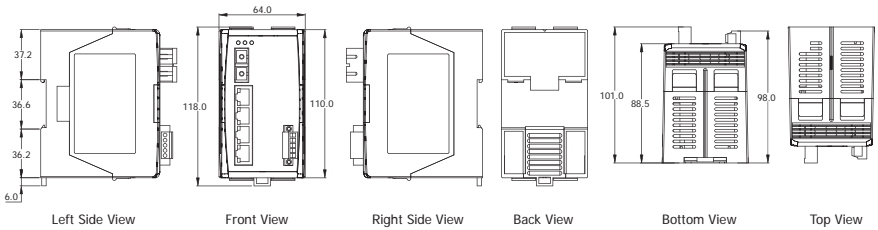

● Ordering Information

<p style="text-align: center;">NS M -205 A F [] [] - 4 0 - []</p>		
<p>M: Metal A: Power Input +12 V_{DC} ~ +48 V_{DC}</p>	<p>Single Mode Distance 40: 40 km Standard Models: 15 km</p>	
<p>Ordering Code Definition</p>	<p>Fiber Port Connector T: Multi Mode ST Connector C: Multi Mode SC Connector CS: Single Mode SC Connector</p>	<p>Operating Temperature T: Operating Temp: -40 °C ~ +75 °C Standard Models: 0 °C ~ +70 °C</p>
<p>Models</p>	<p>NS-205FT, NSM-205FT NS-205FC, NSM-205FC NS-205FCS, NSM-205FCS NS-205AFT, NSM-205AFT NS-205AFC, NSM-205AFC NS-205AFCS, NSM-205AFCS</p>	<p>NS-205AFT-T, NSM-205AFT-T NS-205AFC-T, NSM-205AFC-T NS-205AFCS-T, NSM-205AFCS-T NS-205AFCS-40T, NSM-205AFCS-40T</p>

● Accessories

GPSU06-6	24V/0.25A, 6 W Power Supply
KWM020-1824F	24V/0.75A, 18 W Power Supply
DIN-KA52F	24V/1.04A, 25 W Power Supply with DIN-Rail Mounting

NS-206F/NSM-206F Series

Unmanaged 4-Port Industrial 10/100 Base-TX with Dual 100 Base-FX Fiber Switch

3

Unmanaged Ethernet Switches

NS-206F/NSM-206F Series

Highlight Information ▶▶▶

NS-206F/NSM-206F Series



For NSM-206F Series



For NS-206F Series



NSM-206F Series



NS-206F Series



● Introduction

The NS-206F/NSM-206F series is a Unmanaged 4-Port Industrial 10/100 Base-TX with Dual 100 Base-FX Switch that secures data transmission by using fiber optic transmission to provide immunity from EMI/RFI interference. It is used Ethernet for transmitting a signal up to 2 km (6,600 ft), and is the perfect solution for applications where transmission must be protected from electrical exposure, surges, lightning or chemical corrosion.

The NS-206FT can extend your LAN in a daisy chain configuration. Please refer to Hardware. The Ethernet supports 10/100M auto negotiation feature and auto MDI/MDI-X function.

● Features

- Automatic MDI/MDI-X crossover for plug-and-play
- Each port supports both 10/100 Mbps speed auto negotiation
- Store-and-forward architecture
- Full duplex IEEE 802.3x and half duplex backpressure flow control
- 1.6 Gbps high performance memory bandwidth
- Frame buffer memory: 256 Kbit
- Integrated look-up engine with dedicated 1024 unicast MAC addresses
- Supports +10 V_{DC} ~ +30 V_{DC}
- Supports operating temperatures from 0 °C ~ +70 °C
- Din-Rail

● Specifications

Models	NS-206F Series	NSM-206F Series
Technology		
Standards	IEEE 802.3, 802.3u, 802.3x	
Processing Type	Store & forward, wire speed switching	
MAC Addresses	1024	
Memory Bandwidth	1.6 Gbps	
Frame Buffer Memory	256 Kbit	
Flow Control	IEEE 802.3x flow control, back pressure flow control	
Interface		
RJ-45 Ports	10/100 Base-TX auto negotiation speed, F/H duplex mode, and auto MDI/MDI-X connection	
Fiber Port	100 Base-FX	
LED Indicators	10/100M, Link/Act, Full duplex/Half duplex (Fiber Port)	
Ethernet Isolation	1500 V _{rms} 1 minute	
Frame Ground for EMS Protection	Yes	
Multi Mode	Multi Mode Fiber Cables: 50/125, 62.5/125 or 100/140 μm	
	Distance: 2 km, (62.5/125 μm recommended) for full duplex	
	Wavelength: 1300 or 1310 nm	
	Min. TX Output: -20 dBm	
	Max. TX Output: -14 dBm	
Single Mode	Single Mode Fiber Cables: 8.3/125, 8.7/125, 9/125 or 10/125 μm	
	Distance: 15 km, (9/125 μm recommended) for full duplex	
	Wavelength: 1300 or 1310 nm	
	Min. TX Output: -15 dBm	
	Max. TX Output: -8 dBm	
Ethernet Transmission Distance	Ethernet: 2-pair UTP/STP Cat.3, 4, 5, EIA/TIA-568 100 Ω	
	Fast Ethernet: 2-pair UTP/STP Cat. 5, EIA/TIA-568 100 Ω	
Power		
Input Voltage Range	+10 V _{DC} ~ +30 V _{DC} (Non-isolation)	+10 V _{DC} ~ +30 V _{DC} (Non-isolation) Redundant Inputs
Power Consumption	0.24 A @ 24 V _{DC} , +/-5% arrowed with 100M Full duplex	
LED Indicator	Yes	
Protection	Power reverse polarity protection	
Frame Ground for EMS Protection	Yes	
Mechanical		
Casing	Plastic (Flammability UL 94V-0)	Metal (IP20 Protection)
Dimensions (W x L x H)	64 mm x 101 mm x 118 mm	73 mm x 105 mm x 132 mm
Installation	DIN-Rail	DIN-Rail or Wall Mounting
Environmental		
Operating Temperature	0 °C ~ +70 °C	
Storage Temperature	-20 °C ~ +85 °C	
Ambient Relative Humidity	10% ~ 90% RH, non-condensing	

LED Functions

NSM-206F Series LED Indicator Functions

LED	Color	Description
PWR_OK	Red On	Core Power is OK
	Red Off	Core Power is Off
Full for P0	Green On	Link/Act
	Green Off	Not Networking
Link for P1	Yellow On	Link/Act
	Yellow Off	Not Networking
Ethernet Port (P2 ~ P5)	Green On	Link/Act
	Green Off	Not Networking
	Yellow On	Link to 100 Mbps
	Yellow Off	Link to 10 Mbps
PWR2	Green On	Power is being supplied to power input PWR2
	Green Off	Power is not being supplied to power input PWR2
	Yellow On	Power is being supplied to power input PWR1
PWR1	Yellow Off	Power is not being supplied to power input PWR1
FAULT	Yellow Off	Power is not being supplied to power input PWR1 and PWR2
	Red On	Power is not being supplied to power input PWR1 and PWR2
	Red Off	Power is being supplied to power input PWR1 and PWR2

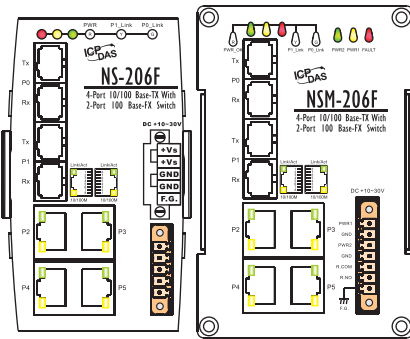

NS-206F Series LED Indicator Functions

LED	Color	Description
Power	Red On	Power is On
	Red Off	Power is Off
Fiber Port (P0)	Green On	Link/Act
	Green Off	Not Networking
Fiber Port (P1)	Yellow On	Link/Act
	Yellow Off	Not Networking
Ethernet Port (P2 ~ P5)	Green On	Link/Act
	Green Off	Not Networking
	Yellow On	Link to 100 Mbps
	Yellow Off	Link to 10 Mbps

Applications

Fiber Daisy Chain Configuration

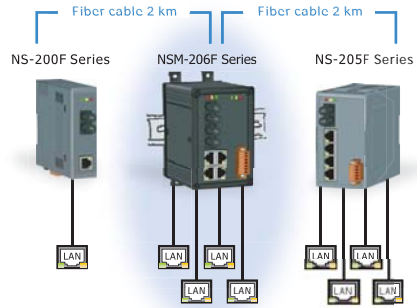

Appearance

NSM-206F Series

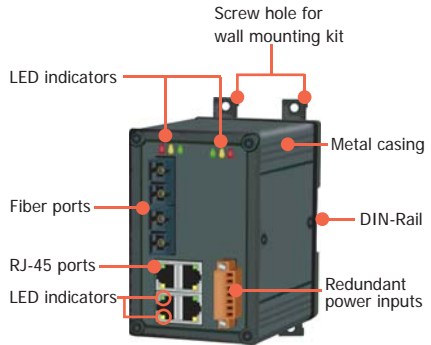

NS-206F Series

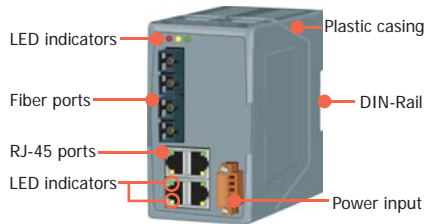

● Dimensions (Unit: mm)

NSM-206F Series

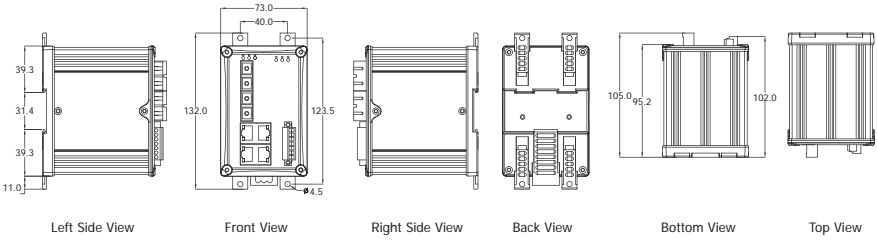

NS-206F Series

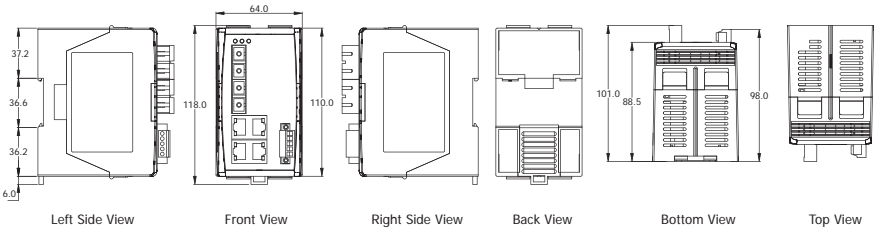

● Ordering Information

<p style="text-align: center;">NS M -206 A F [] - 4 0 - []</p> <p> M: Metal A: Power Input +12 V_{DC} ~ +48 V_{DC} 40: 40 km 40: 40 km 15 km: Standard Models: 15 km </p>		
Ordering Code Definition	Fiber Port Connector	Operating Temperature
	T: Multi Mode ST Connector C: Multi Mode SC Connector CS: Single Mode SC Connector	T: Operating Temp: -40 °C ~ +75 °C Standard Models: 0 °C ~ +70 °C
Models	NS-206FT, NSM-206FT NS-206FC, NSM-206FC NS-206FCS, NSM-206FCS NS-206AFT, NSM-206AFT NS-206AFC, NSM-206AFC NS-206AFCS, NSM-206AFCS	NS-206AFT-T, NSM-206AFT-T NS-206AFC-T, NSM-206AFC-T NS-206AFCS-T, NSM-206AFCS-T NS-206AFCS-40T, NSM-206AFCS-40T

● Accessories

MDR-20-24	24V/1A, 24 W Power Supply with DIN-Rail Mounting
KWM020-1824F	24V/0.75A, 18 W Power Supply
DIN-KA52F	24V/1.04A, 25 W Power Supply with DIN-Rail Mounting

NS-209F/NSM-209F Series



Unmanaged 8-Port Industrial 10/100 Base-TX with 100 Base-FX Fiber Switch

3

Unmanaged Ethernet Switches

NS-209F/NSM-209F Series

Highlight Information ▶▶▶

NS-209F/NSM-209F Series



For NSM-209F Series



For NS-209F Series



NSM-209F Series

NS-209F Series



● Introduction

The NS-209F/NSM-209F series is a Unmanaged 8-Port Industrial 10/100 Base-TX with 100 Base-FX Switch that secures data transmission by using fiber optic transmission to provide immunity from EMI/RFI interference. It is used Ethernet for transmitting a signal up to 15 km, and is the perfect solution for applications where transmission must be protected from electrical exposure, surges, lightning or chemical corrosion.

The NS-209F/NSM-209F series operates at full duplex mode. In full duplex mode, range is 15 km with 8.3/125, 8.7/125, 9/125 or 10/125 μ m fiber cables.

The Ethernet supports 10/100M auto negotiation feature and auto MDI/MDI-X function.

● Features

- Automatic MDI/MDI-X crossover for plug-and-play
- Each port supports both 10/100 Mbps speed auto negotiation
- Store-and-forward architecture
- Full duplex IEEE 802.3x and half duplex backpressure flow control
- 2 Gbps high performance memory bandwidth
- Integrated look-up engine with dedicated 2048 unicast MAC addresses
- Supports +12 Vdc ~ +48 Vdc
- Supports operating temperatures from 0 °C ~ +70 °C
- DIN-Rail

● Specifications

Models	NS-209F Series	NSM-209F Series
Technology		
Standards	IEEE 802.3, 802.3u, 802.3x	
Processing Type	Store & forward, wire speed switching	
MAC Addresses	2048	
Memory Bandwidth	2 Gbps	
Frame Buffer Memory	512 Kbit	
Flow Control	IEEE 802.3x flow control, back pressure flow control	
Interface		
RJ-45 Ports	10/100 Base-TX auto negotiation speed, F/H duplex mode, and auto MDI/MDI-X connection	
Fiber Optics Port	100 Base-FX	
LED Indicators	10/100M, Link/Act, Full duplex/Half duplex (Fiber Port)	
Ethernet Isolation	1500 V _{rms} 1 minute	
Frame Ground for EMS Protection	Yes	
Multi Mode	Multi Mode Fiber Cables: 50/125, 62.5/125 or 100/140 μm	
	Distance: 2 km, (62.5/125 μm recommended) for full duplex	
	Wavelength: 1300 or 1310 nm	
	Min. TX Output: -20 dBm	
	Max. TX Output: -14 dBm	
Single Mode	Single Mode Fiber Cables: 8.3/125, 8.7/125, 9/125 or 10/125 μm	
	Distance: 15 km, (9/125 μm recommended) for full duplex	
	Wavelength: 1300 or 1310 nm	
	Min. TX Output: -15 dBm	
	Max. TX Output: -8 dBm	
Ethernet Transmission distance	Ethernet: 2-pair UTP/STP Cat.3, 4, 5, EIA/TIA-568 100 Ω	
	Fast Ethernet: 2-pair UTP/STP Cat. 5, EIA/TIA-568 100 Ω	
Power		
Input Voltage Range	+12 V _{DC} ~ +48 V _{DC} (Non-isolation)	+12 V _{DC} ~ +48 V _{DC} (Non-isolation) Redundant Inputs
Power Consumption	0.15 A @ 24 V _{DC} , +/-5% arrowed with 100M Full duplex	
LED Indicator	Yes	
Protection	Power reverse polarity protection	
Frame Ground for EMS Protection	Yes	
Mechanical		
Casing	Plastic (Flammability UL 94V-0)	Metal (IP20 Protection)
Dimensions (W x L x H)	64 mm x 101 mm x 118 mm	73 mm x 105 mm x 132 mm
Installation	DIN-Rail	DIN-Rail or Wall Mounting
Environmental		
Operating Temperature	0 °C ~ +70 °C	
Storage Temperature	-20 °C ~ +85 °C	
Ambient Relative Humidity	10% ~ 90% RH, non-condensing	

LED Functions

NSM-209F Series LED Indicator Functions

LED	Color	Description
PWR_OK	Red On	Core Power is OK
	Red Off	Core Power is Off
Full for P0	Yellow On	Full Duplex
	Yellow Off	Half Duplex
Link for P0	Green On	Link/Act
	Green Off	Not Networking
Ethernet Port (P1 ~ P8)	Green On	Link/Act
	Green Off	Not Networking
	Yellow On	Link to 100 Mbps
	Yellow Off	Link to 10 Mbps
PWR2	Green On	Power is being supplied to power input PWR2
	Green Off	Power is not being supplied to power input PWR2
PWR1	Yellow On	Power is being supplied to power input PWR1
FAULT	Yellow Off	Power is not being supplied to power input PWR1
	Red On	Power is not being supplied to power input PWR1 and PWR2
	Red Off	Power is being supplied to power input PWR1 and PWR2

Redundant Power Inputs

Both power inputs can be connected simultaneously to live DC power sources. If one power source fails, the other live source acts as a backup, and automatically supplies all of NSM-209F series power needs.

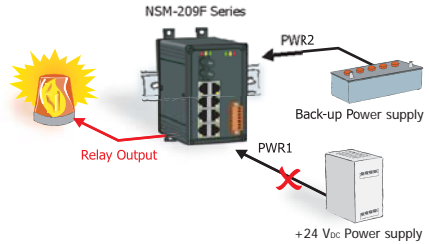

Appearance

NSM-209F Series

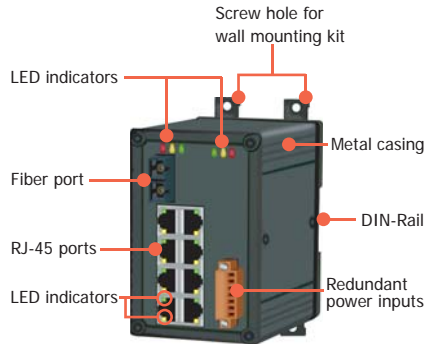
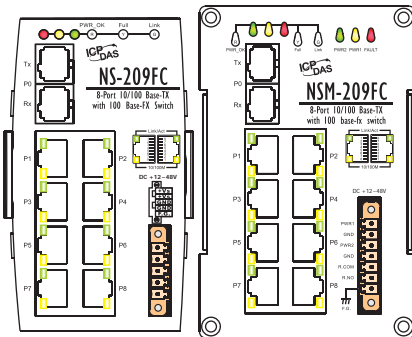

NS-209F Series

NS-209F Series LED Indicator Functions

LED	Color	Description
Power	Red On	Power is On
	Red Off	Power is Off
	Yellow On	Full Duplex Mode
Fiber Port (P0)	Yellow Off	Half Duplex Mode
	Green On	Link/Act
	Green Off	Not Networking
	Green On	Link/Act
Ethernet Port (P1 ~ P8)	Green On	Link/Act
	Green Off	Not Networking
	Yellow On	Link to 100 Mbps
	Yellow Off	Link to 10 Mbps

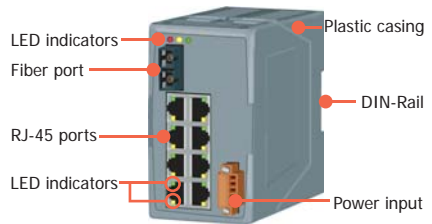

● Dimensions (Unit: mm)

NSM-209F Series

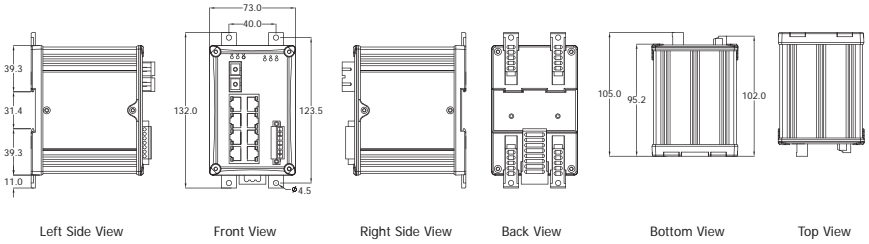

NS-209F Series

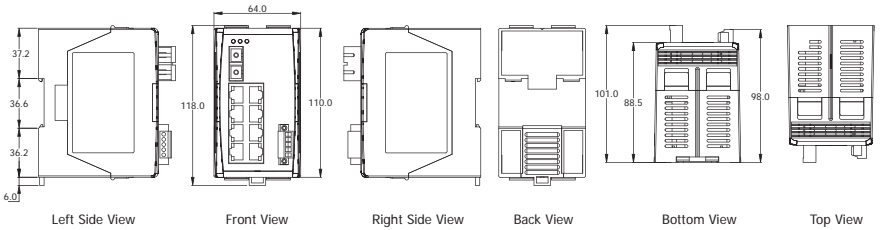

● Ordering Information

<p style="text-align: center;">NS M -209F - 40 - </p> <p style="text-align: center;">M: Metal</p> <p style="text-align: center;">Single Mode Distance 40: 40 km Standard Models: 15 km</p>		
Ordering Code Definition	Fiber Port Connector	Operating Temperature
	T: Multi Mode ST Connector C: Multi Mode SC Connector CS: Single Mode SC Connector	T: Operating Temp: -40 °C ~ +75 °C Standard Models: 0 °C ~ +70 °C
Models	NS-209FT, NSM-209FT NS-209FC, NSM-209FC NS-209FCS, NSM-209FCS	NS-209FT-T, NSM-209FT-T NS-209FC-T, NSM-209FC-T NS-209FCS-T, NSM-209FCS-T NS-209FCS-40T, NSM-209FCS-40T

● Accessories

GPSU06-6	24V/0.25A, 6 W Power Supply
KWM020-1824F	24V/0.75A, 18 W Power Supply
DIN-KA52F	24V/1.04A, 25 W Power Supply with DIN-Rail Mounting

NS-205PFx series/NSM-205PFx series

4-Port 10/100 Mbps PoE (PSE) with 1 fiber port Switch

Highlight Information ▶▶▶

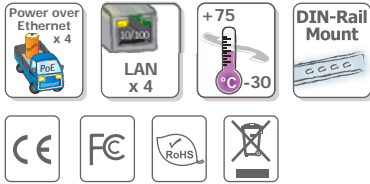

NS-205PFx series NSM-205PFx series



● Introduction

The NS-205PFx/NSM-205PFx is a 4-port unmanaged PoE (PSE) with 1 fiber port switch; it supports 4 PoE ports which are classified as power source equipments (PSE). The NS-205PFx/NSM-205PFx makes centralized power supply come true and provides up to 15.4 watts of power per PSE port. Using fiber optics, you can prevent noise from interfering with your system and supports high-speed (100 Mbps) and high-distance (up to 60 km) transmissions.

● Features

- Provides 1 x 100-FX fiber port plus 4 x PoE ports
- Automatic MDI/MDI-X crossover for plug-and-play
- Each port supports both 10/100Mbps speed auto negotiation
- Store-and-forward architecture
- Full duplex IEEE 802.3x and half duplex backpressure flow control
- 4 PoE ports with Power Sourcing Equipment (PSE) operation
- Auto-detection of PD (powered devices) and automatic power management
- Over-temperature, over-current and over/under-voltage detection
- Power Input, +46 ~ +55 V_{dc}
- Supports operating temperatures from -30 ~ +75°C
- DIN-Rail

● Specifications

Models	NS-205PFx series	NSM-205PFx series
Technology		
Standards	IEEE 802.3, 802.3u, 802.3x ,802.3af (Power over Ethernet)	
Processing Type	Store & forward; wire speed switching	
MAC Addresses	1024	
Memory Bandwidth	3.2 Gbps	
Frame Buffer Memory	512 Kbit	
Flow Control	IEEE 802.3x flow control, back pressure flow control	
Ethernet Interface		
RJ-45 Ports	10/100 Base-T(X) auto negotiation speed, F/H duplex mode, and auto MDI/MDI-X connection	
LED Indicators	Power, Link/Act , 10/100M, Power Device is detected	
Ethernet Isolation	1500 V _{rms} 1 minute	
+/-6 kV EMS Protection	Yes	
Fiber Interface (100 Base-FX; SC/ST type)		
Multi-Mode (NS-205PFT/FC)	Multi mode fiber cables:50/125, 62.5/125 or 100/140 μm Distance :2 km, (62.5/125 μm recommended) for full duplex Wavelength : 1300 or 1310nm Min. TX Output:- 20 dBm Max. TX Output: -14 dBm Max. RX Sensitivity: -32 dBm Max. RX Overload: -8 dBm Budget: 12 dBm	
Single-Mode (NS-205PFCS)	Single-mode fiber cables: 8.3/125, 8.7/125, 9/125 or 10/125μm Distance: 30 Km, (9/125 μm recommended) for full duplex Wavelength: 1300 or 1310nm Min. TX Output: - 15 dBm Max. TX Output: -8 dBm Max. RX Sensitivity: -34 dBm Max. RX Overload: -5 dBm Budget: 19 dBm	
Single-Mode (NS-205PFCS-60)	Single-mode fiber cables: 8.3/125, 8.7/125, 9/125 or 10/125μm Distance: 60 Km, (9/125 μm recommended) for full duplex Wavelength: 1300 or 1310nm Min. TX Output: - 5 dBm Max. TX Output: 0 dBm Max. RX Sensitivity: -35 dBm Max. RX Overload: -5 dBm Budget: 30 dBm	
Power Input		
Input Voltage Range	+46 ~ +55 VDC for PoE output	
Power consumption	0.08@ 48 VDC without PD loading	
Protection	Power reverse polarity protection	
+/- 4kV EMS Protection	Yes	
Connection	3-Pin Removable Terminal Block	
PoE Output (Port1 ~ 4)		
PoE Compliance	100% IEEE 802.3af compliant	
PoE Classification	PSE (Power Sourcing Equipment)	
PoE Voltage	+48 VDC depending on power input	
PoE Power	Up to 15.4 watts per channel	
PoE Operation	Automatic detection and power management	

Mechanical		
Casing	Plastic (Flammability UL 94V-0)	Metal (IP30 Protection)
Dimensions (W x L x H)	31 mm x 157 mm x 113 mm	25 mm x 168 mm x 119 mm
Installation	DIN-Rail	
Environmental		
Operating Temperature	-30 °C ~ +75 °C	
Storage Temperature	-40 °C ~ +85 °C	
Ambient Relative Humidity	10% ~ 90% RH, non-condensing	

LED Functions

LED Indicator Functions		
LED	Color	Description
Power	Red On	Power is On
	Red Off	Power is Off
Port 1 ~ Port 4	Orange On	Power Device is detected
	Green On	Link/Act
Port 5	Green On	Link/Act

Pin Function for Terminal Block

External power supply is connected using the removable terminal block:

PWR : Power input (+46 V_{DC} ~ +55 V_{DC}) and should be connected to the power supply (+)

GND : Ground and should be connected to the power supply (-)

F.G. : F.G. stands for Frame Ground (protective ground). It is optional. If you use this pin, it can reduce EMI radiation; improve EMI performance and ESD protection.

Applications

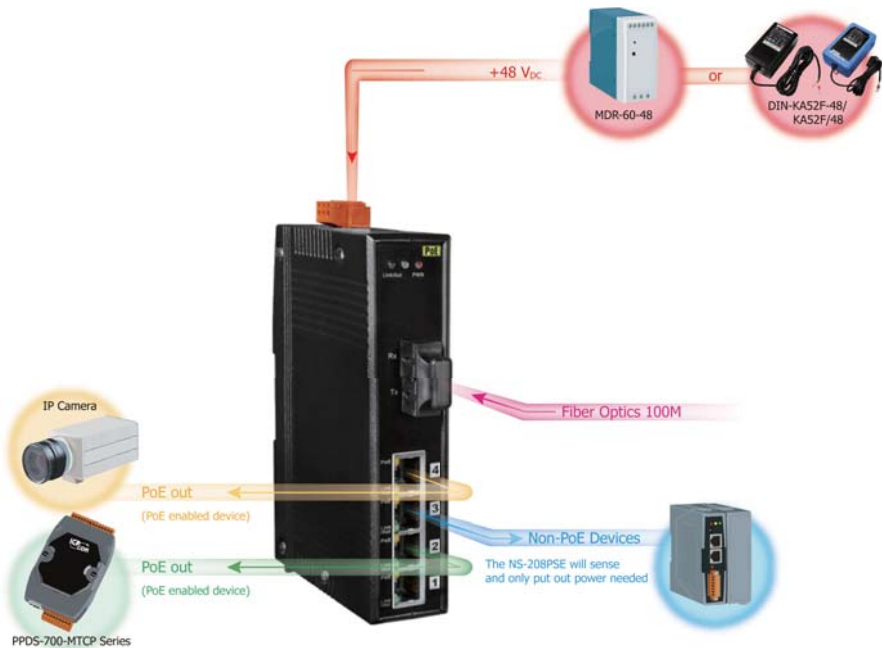

● Dimensions (Unit: mm)

NS-205PFx series

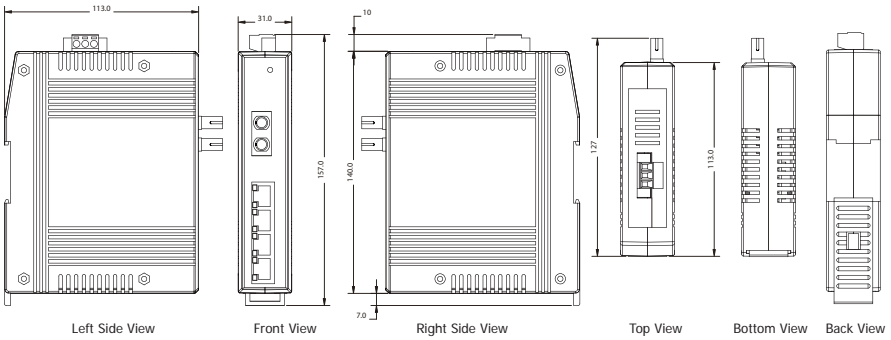

NS-205PFx series

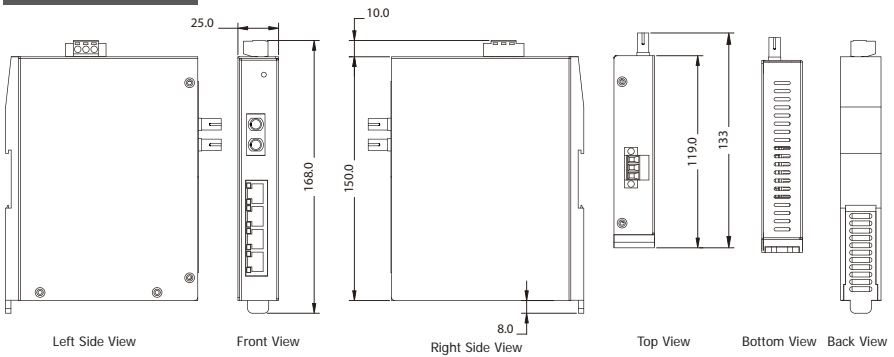

● Ordering Information

NS-205PFT CR	Multi-mode, ST Connector, 4-Port 10/100 Mbps PoE (PSE) with 1 Fiber port Switch (RoHS)
NS-205PFC CR	Multi-mode, SC Connector, 4-Port 10/100 Mbps PoE (PSE) with 1 Fiber port Switch (RoHS)
NS-205PFCS CR	Single-mode 30 Km, SC Connector, 4-Port 10/100 Mbps PoE (PSE) with 1 Fiber port Switch (RoHS)
NS-205PFCS-60 CR	Single-mode 60 Km, SC Connector, 4-Port 10/100 Mbps PoE (PSE) with 1 Fiber port Switch (RoHS)
NSM-205PFT CR	Multi-mode, ST Connector, 4-Port 10/100 Mbps PoE (PSE) with 1 Fiber port Switch; metal case (RoHS)
NSM-205PFC CR	Multi-mode, SC Connector, 4-Port 10/100 Mbps PoE (PSE) with 1 Fiber port Switch; metal case (RoHS)
NSM-205PFCS CR	Single-mode 30 Km, SC Connector, 4-Port 10/100 Mbps PoE (PSE) with 1 Fiber port Switch; metal case (RoHS)
NSM-205PFCS-60 CR	Single-mode 60 Km, SC Connector, 4-Port 10/100 Mbps PoE (PSE) with 1 Fiber port Switch; metal case (RoHS)

● Accessories

MDR-60-48	48V/1.25A, 60 W Power Supply with DIN-Rail Mounting
DIN-KA52F-48	48V/0.52A, 25 W Power Supply with DIN-Rail Mounting
KA52F-48	48V/0.52A, 25 W Power Supply

NS-205-IP67 Series



Unmanaged 5-Port Industrial Ethernet Switch with IP67 Casing

3

Unmanaged Ethernet Switches

NS-205-IP67 Series

Highlight Information >>>

NS-205-IP67 Series

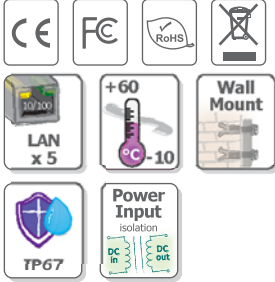

Only for NS-205-IP67/DIN



NS-205-IP67/DIN



NS-205-IP67



● Introduction

NS-205-IP67 ethernet switches are designed for use in industrial waterproof/harsh environments. The rugged packaging and IP67 connectors guarantee a total protection that can withstand a variety of extreme conditions such as high temperatures, extreme shocks & vibrations, dust particles or even liquid immersion. They can be directly mounted to any machine or convenient flat surface. Even with all its rugged features, the switch still provides a high level of functionality, including the ability to support full-duplex communication and 10 Mbps/100 Mbps transmission speeds. With 1.4 Gbps of total bandwidth, the switch can simultaneously handle full wire speed communication on each port. A dedicated uplink port enables a connection to other switches without use of a crossover cable. No programming is necessary, as the switch auto-learns network addresses. +10 V_{DC} ~ +30 V_{DC} isolated power input keeps spikes and surges on the power line from damaging the power supply. They are completely plug and play and ready to go right out of the box.

● Features

- Automatic MDI/MDI-X crossover for plug-and-play
- Each port supports both 10/100 Mbps speed auto negotiation
- Store-and-forward architecture
- Full duplex IEEE 802.3x and half duplex backpressure flow control
- 1.4 Gbps high performance memory bandwidth
- Integrated look-up engine with dedicated 1024 unicast MAC addresses
- Supports +10 V_{DC} ~ +30 V_{DC} with 1 kV isolation Reverse Polarity Protection
- Plastic casing with IP67

● Specifications

Models	NS-205-IP67	NS-205-IP67/DIN
Technology		
Standards	IEEE 802.3, 802.3u, 802.3x	
Processing Type	Store & forward, wire speed switching	
MAC Addresses	1024	
Memory Bandwidth	1.4 Gbps	
Frame Buffer Memory	256 Kbit	
Flow Control	IEEE 802.3x flow control, back pressure flow control	
Interface		
RJ-45 Ports	10/100 Base-TX auto negotiation speed, F/H duplex mode, and auto MDI/MDI-X connection	
LED Indicators	Power, 10/100M, Link/Act	
Cable	10 Base-T (Cat.3, 4,5 UTP cable; 100m Max.)	
	100 Base-TX (Cat.5 UTP cable; 100m Max.)	
Power		
Input Voltage	+10 V _{DC} ~ +30 V _{DC} (1 kV isolation)	
Power Consumption	0.12 A @ 24 V _{DC} , +/-5% arrowed with 10M Full duplex	
	0.1 A @ 24 V _{DC} , +/-5% arrowed with 100M Full duplex	
Mechanical		
Casing	Plastic	
Flammability	UL 94V-0	
Environmental Rating	Protection rating IP67 for Operating Temperature -10 °C ~ +60 °C	
	Protection rating IP66 for for Operating Temperature -40 °C ~ +80 °C	
Dimensions (W x L x H)	85 mm x 76 mm x 137 mm	89 mm x 90 mm x 138 mm
Installation	Wall mounting	DIN-Rail or Wall Mounting
Environmental		
Operating Temperature	-10 °C ~ +60 °C (Protection rating IP67)	
	-40 °C ~ +80 °C (Protection rating IP66)	
Storage Temperature	-10 °C ~ +60 °C (Protection rating IP67)	
	-40 °C ~ +85 °C (Protection rating IP66)	
Ambient Relative Humidity	100% RH for Operating Temperature -10 °C ~ +60 °C	
	10% ~ 90% RH, non-condensing for Operating Temperature -40 °C ~ +80 °C	

LED Functions

LED Indicator Functions

LED	Color	Description
PWR	Red	Power is On
	Off	Power is Off
10/100M (Port 1)	Orange	Link to 10 Mbps
	Green	Link to 100 Mbps
	Off	Not Networking
10/100M (Port 2)	Orange	Link to 10 Mbps
	Green	Link to 100 Mbps
	Off	Not Networking
10/100M (Port 3)	Orange	Link to 10 Mbps
	Green	Link to 100 Mbps
	Off	Not Networking
10/100M (Port 4)	Orange	Link to 10 Mbps
	Green	Link to 100 Mbps
	Off	Not Networking
10/100M (Port 5)	Orange	Link to 10 Mbps
	Green	Link to 100 Mbps
	Off	Not Networking

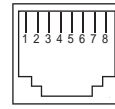
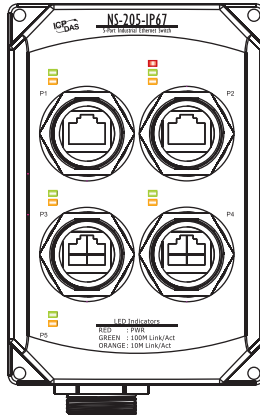

RJ-45 Pin-Out

Pin#	Signal Name	Function
1	TD+	Transmit Data
2	TD-	Transmit Data
3	RD+	Receive Data
4	NC	No Connection
5	NC	No Connection
6	RD-	Receive Data
7	NC	No Connection
8	NC	No Connection

Pin Function for Terminal Block

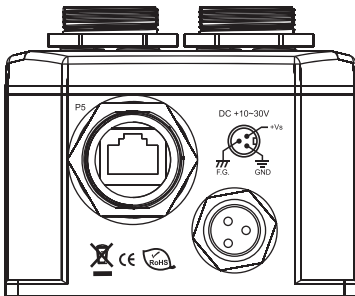

External power supply is connected using the removable terminal block:

+Vs : Power input (+10 V_{DC} – +30 V_{DC}) and should be connected to the power supply (+)

GND: Ground and should be connected to the power supply (-)

F.G. : F.G. stands for Frame Ground (protective ground). It is optional. If you use this pin, it can reduce EMI radiation; improve EMI performance and ESD protection.

● Appearance

NS-205-IP67/DIN

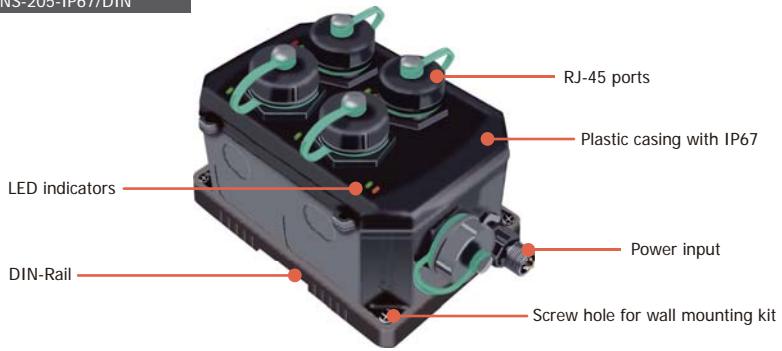

● Applications



- ☑ Direct fieldbus-style installation - No enclosure required.
- ☑ Reduce installation cost
- ☑ Mount anywhere-Save space



● Dimensions (Unit: mm)

NS-205-IP67

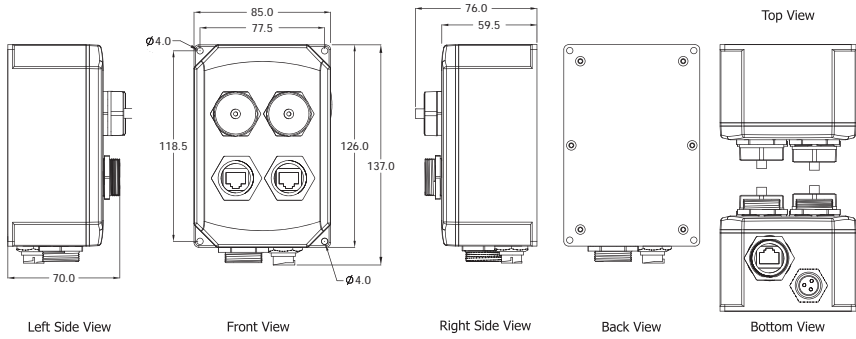

IP67 Ethernet Cap with Tether

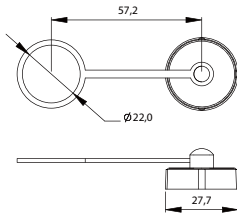

IP67 Ethernet Plug

Cable Dia:
Max. 7.0 mm
Min. 5.5 mm

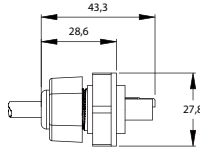

IP67 PWR Plug

Cable Dia:
Max. 6.5 mm
Min. 5.0 mm

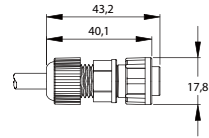

● Ordering Information

NS-205-IP67 CR	Unmanaged 5-Port Industrial Ethernet Switch with IP67 Casing (RoHS)
NS-205-IP67/DIN CR	NS-205-IP67 with DIN-Rail Mount (RoHS)

● Accessories

GPSU06-6	24V/0.25A, 6 W Power Supply
KWM020-1824F	24V/0.75A, 18 W Power Supply
DIN-KA52F	24V/1.04A, 25 W Power Supply with DIN-Rail Mounting

Media Converters

4



NS-200F Series

Industrial 10/100 Base-TX to 100 Base-FX Media Converter

4

Media Converters NS-200F Series

Highlight Information ▶▶▶

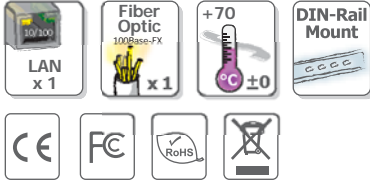

NS-200FC/FCS Series

NS-200FT Series



● Introduction

The NS-200F series is a Ethernet (10/100 Base-TX) to Media (100 Base-FX) converter. The Ethernet supports 10/100M auto negotiation feature and auto MDI/MDI-X function.

The NS-200F series operates at either half or full duplex mode.

It contains "soft start" function with overload protection, high-low voltage protection.

The width of the NS-200F series is just 33 mm, so it can be used where space is important.

● Features

- Automatic MDI/MDI-X crossover for plug-and-play
- Supports both 10/100 Mbps speed auto negotiation
- Store-and-forward architecture
- Full duplex IEEE 802.3x and half duplex backpressure flow control
- 1.4 Gbps high performance memory bandwidth
- Frame buffer memory: 256 Kbit
- Integrated look-up engine with dedicated 1024 unicast MAC addresses
- Supports +10 V_{dc} ~ +30 V_{dc} Reverse Polarity Protection
- Supports operating temperatures from 0 °C ~ +70 °C
- DIN-Rail mount for industrial usage

● Specifications

Technology	
Standards	IEEE 802.3, 802.3u, 802.3x
Processing Type	Store & forward, wire speed switching
MAC Addresses	1024
Memory Bandwidth	1.4 Gbps
Frame Buffer Memory	256 Kbit
Flow Control	IEEE 802.3x flow control, back pressure flow control
Interface	
RJ-45 Port	10/100 Base-TX auto negotiation speed, F/H duplex mode, and auto MDI/MDI-X connection
Fiber Port	100 Base-FX
LED Indicators	10/100M, Link/Act, Full duplex/Half duplex (Fiber Port)
Ethernet Isolation	1500 V _{rms} 1 minute
Frame Ground for EMS Protection	Yes
Multi Mode	Multi Mode Fiber Cables: 50/125, 62.5/125 or 100/140 μm
	Distance: 2 km, (62.5/125 μm recommended) for full duplex
	Wavelength: 1300 or 1310 nm
	Min. TX Output: -20 dBm
	Max. TX Output: -14 dBm
Single Mode	Single Mode Fiber Cables: 8.3/125, 8.7/125, 9/125 or 10/125 μm
	Distance: 15 km, (9/125 μm recommended) for full duplex
	Wavelength: 1300 or 1310 nm
	Min. TX Output: -15 dBm
	Max. TX Output: -8 dBm
Ethernet Transmission Distance	Ethernet: 2-pair UTP/STP Cat.3, 4, 5, EIA/TIA-568 100 Ω
	Fast Ethernet: 2-pair UTP/STP Cat. 5, EIA/TIA-568 100 Ω
Power	
Input Voltage Range	+10 V _{DC} ~ +30 V _{DC} (Non-isolation)
Power Consumption	0.12 A @ 24 V _{DC} , +/-5% arrowed with 100M Full duplex
LED Indicator	Yes
Protection	Power reverse polarity protection
Frame Ground for EMS Protection	Yes
Mechanical	
Casing	Plastic (Flammability UL 94V-0)
Dimensions (W x L x H)	33 mm x 85 mm x 107 mm
Installation	DIN-Rail
Environmental	
Operating Temperature	0 $^{\circ}\text{C}$ ~ +70 $^{\circ}\text{C}$
Storage Temperature	-20 $^{\circ}\text{C}$ ~ +85 $^{\circ}\text{C}$
Ambient Relative Humidity	10% ~ 90% RH, non-condensing

LED Functions

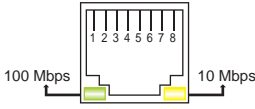

LED Indicator Functions

LED	Color	Description
PWR	Red	Power is On
	Off	Power is Off
Fiber Optic	Yellow_On	Full Duplex Mode
	Yellow_Off	Half Duplex Mode
	Green_On	Link/Act
	Green_Off	Not Networking
Ethernet	Yellow	Link to 10 Mbps
	Green	Link to 100 Mbps
	Off	Not Networking

RJ-45 Pin-Out

Pin#	Signal Name	Function
1	TD+	Transmit Data
2	TD-	Transmit Data
3	RD+	Receive Data
4	NC	No Connection
5	NC	No Connection
6	RD-	Receive Data
7	NC	No Connection
8	NC	No Connection

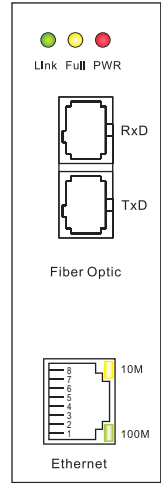

Pin Function for Terminal Block

External power supply is connected using the removable terminal block:

+Vs : Power input +10 V_{DC} ~ +30 V_{DC}

GND: Ground

F.G. : F.G. stands for Frame Ground (protective ground). It is optional. If you use this pin, it can reduce EMI radiation; improve EMI performance and ESD protection.

Appearance

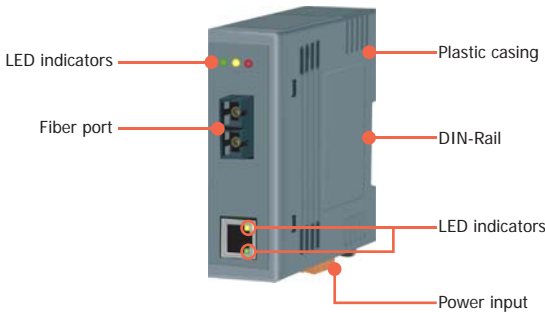

● Dimensions (Unit: mm)

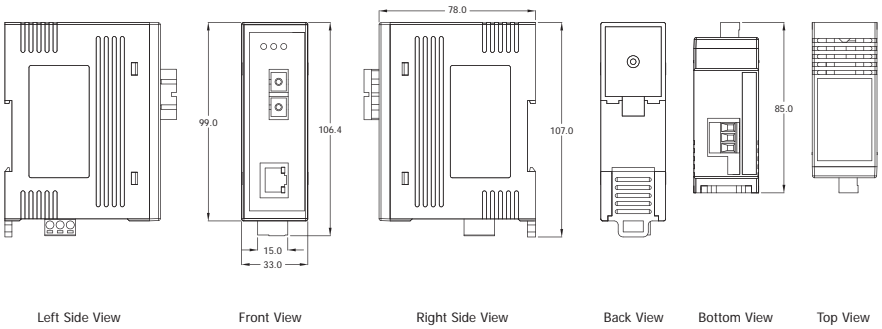

● Ordering Information

NS-200 A F - 4 0 - 		
A: Power Input +12 V _{DC} ~ +48 V _{DC}		
Single Mode Distance 40: 40 km Standard Models: 15 km		
Ordering Code Definition	Fiber Port Connector	Operating Temperature
	T: Multi Mode ST Connector C: Multi Mode SC Connector CS: Single Mode SC Connector	T: Operating Temp: -40 °C ~ +75 °C Standard Models: 0 °C ~ +70 °C
Models	NS-200FT NS-200FC NS-200FCS NS-200AFT NS-200AFC NS-200AFCS	NS-200AFT-T NS-200AFC-T NS-200AFCS-T NS-200AFCS-40T

● Accessories

GPSU06-6	24V/0.25A, 6 W Power Supply
KWM020-1824F	24V/0.75A, 18 W Power Supply
DIN-KA52F	24V/1.04A, 25 W Power Supply with DIN-Rail Mounting

NS-200G Series Available Soon

Industrial 1000 Base-T to 1000 Base-SX/LX Media Converters

4

Media Converters

NS-200G Series

Highlight Information ▶▶▶

NS-200G Series

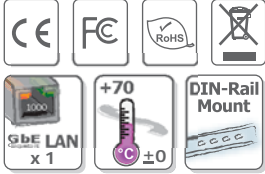

For NS-200GSX



For NS-200GLX



NS-200GSX/LX

NS-200G



● Introduction

The NS-200G series provides one RJ-45 auto sensing 10/100/1000 Base-T port and one 1000 Base-SX/LX SFP port. The RJ-45 port is full/half duplex capable.

The NS-200G auto-negotiates the speed and flow control capabilities of the copper port connection, and configures itself automatically. The 1000 Base-SX/LX fiber optic port utilizes industry standard SFP transceivers with LC style connectors and is configured for full duplex operation. Both multi-mode and single-mode fiber models are available.

The width of the NS-200G series is just 33 mm, so it can be used where space is important.

● Features

- Automatic MDI/MDI-X crossover for plug-and-play
- Store-and-forward architecture
- Full duplex IEEE 802.3x
- Supports +12 V_{DC} ~ +48 V_{DC} Reverse Polarity Protection
- Supports operating temperatures from 0 °C ~ +70 °C
- DIN-Rail mount

● Specifications

Technology	
Standards	IEEE 802.3, 802.3u, 802.3x, 802.3ab, 802.3z
Processing Type	Store & forward, wire speed switching
MAC Addresses	1024
Interface	
RJ-45 Port	1000 Base-T auto MDI/MDI-X connection
Fiber Port	1000 Base-SX/LX
LED Indicators	10/100/1000M, Link/Act
Ethernet Isolation	1500 V _{rms} 1 minute
Frame Ground for EMS Protection	Yes
Power	
Input Voltage Range	+12 V _{DC} ~ +48 V _{DC} (Non-isolation)
Power Consumption	0.15 A @ 24 V _{DC} , +/-5% arrowed
LED Indicator	Yes
Protection	Power reverse polarity protection
Frame Ground for EMS Protection	Yes
Mechanical	
Casing	Plastic (Flammability UL 94V-0)
Dimensions (W x L x H)	33 mm x 85 mm x 107 mm
Installation	DIN-Rail
Environmental	
Operating Temperature	0 °C ~ +70 °C
Storage Temperature	-20 °C ~ +85 °C
Ambient Relative Humidity	10% ~ 90% non-condensing

● Ordering Information

NS-200G CR	1000 Base-T to 1000 Base-SX/LX Media Converter Without SPF Module (RoHS)
NS-200GSX CR	1000 Base-T to 1000 Base-SX Multi Mode Media Converter (RoHS)
NS-200GLX CR	1000 Base-T to 1000 Base-LX Single Mode Media Converter (RoHS)

● Accessories

GPSU06-6	24V/0.25A, 6 W Power Supply
KWM020-1824F	24V/0.75A, 18 W Power Supply
DIN-KA52F	24V/1.04A, 25 W Power Supply with DIN-Rail Mounting

NS-200WDM Series NEW

Industrial Single-Strand 10/100 Base-TX to 100 Base-FX Media Converter

4

Media Converters

NS-200WDM Series

Highlight Information ▶▶▶

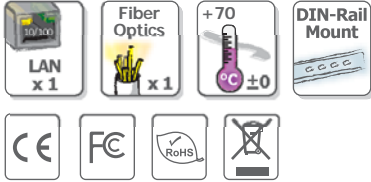

NS-200WDM-A

NS-200WDM-B



● Introduction

Using the fiber optic medium for ethernet applications has become more popular due to fiber optic's excellent physical features, especially for long distance networks. However, fiber optic cable is very expensive, so if we can apply a solution that uses only 1 cable instead of 2, the infrastructure cost can be cut in half. The NS-200WDM Series provides a solution that reduces your expense by 50%!

The NS-200WDM Series of Single-Strand Fiber Converters supports Wavelength Division Multiplexing (WDM) technology that allows two independent data communication channels to transmit and receive over one standard, single mode, fiber optic line. This not only doubles your existing bandwidth, but also effectively reduces the cost of creating a new fiber optic infrastructure.

50% Cost Saving for Fiber Optic Infrastructures

With a pair of NS-200WDM series products (NS-200WDM-A and NS-200WDM-B), you can double the utilization of your existing, costly fiber optic cable, and save 50% of the cost of a newly installed fiber optic application.

It contains "soft start" function with overload protection, high-low voltage protection.

The width of the NS-200WDM is just 33 mm, so it can be used where space is important.

● Features

- Automatic MDI/MDI-X crossover for plug-and-play
- Supports both 10/100 Mbps speed auto negotiation
- Store-and-forward architecture
- Full duplex IEEE 802.3x and half duplex backpressure flow control
- 1.4 Gbps high performance memory bandwidth
- Integrated look-up engine with dedicated 1024 unicast MAC addresses
- Supports +12 V_{DC} ~ +48 V_{DC} Reverse Polarity Protection
- Supports operating temperatures from 0 °C ~ +70 °C
- DIN-Rail

● Specifications

Technology	
Standards	IEEE 802.3, 802.3u, 802.3x
Processing Type	Store & forward, wire speed switching
MAC Addresses	1024
Memory Bandwidth	1.4 Gbps
Frame Buffer Memory	256 Kbit
Flow Control	IEEE 802.3x flow control, back pressure flow control
Interface	
RJ-45 Port	10/100 Base-TX auto negotiation speed, F/H duplex mode, and auto MDI/MDI-X connection
Fiber Port	100 Base-FX (Single Mode; SC Connector)
LED Indicators	10/100M, Link/Act, Full duplex/Half duplex (Fiber Port)
Ethernet Isolation	1500 V _{rms} 1 minute
Frame Ground for EMS Protection	Yes
Single Mode	Single Mode Fiber Cables: 8.3/125, 8.7/125, 9/125 or 10/125 μm Distance: 15 km, (9/125 μm recommended) for full duplex
	Wavelength: TX: 1310, RX: 1550 nm for NS-200WDM-A TX: 1550, RX: 1310 nm for NS-200WDM-B
	Min. TX Output: -14 dBm
	Max. TX Output: -8 dBm
	RX Sensitivity: -31 dBm
Ethernet Transmission Distance	Ethernet: 2-pair UTP/STP Cat.3, 4, 5, EIA/TIA-568 100 Ω Fast Ethernet: 2-pair UTP/STP Cat. 5, EIA/TIA-568 100 Ω
Power	
Input Voltage Range	+12 V _{DC} ~ +48 V _{DC} (Non-isolation)
Power Consumption	0.12 A @ 24 V _{DC} , +/-5% arrowed with 100M Full duplex
LED Indicator	Yes
Protection	Power reverse polarity protection
Frame Ground for EMS Protection	Yes
Connection	3-Pin Removable Terminal Block
Mechanical	
Casing	Plastic
Flammability	UL 94V-0
Dimensions (W x L x H)	33 mm x 85 mm x 107 mm
Installation	DIN-Rail
Environmental	
Operating Temperature	0 °C ~ +70 °C
Storage Temperature	-20 °C ~ +85 °C
Ambient Relative Humidity	10% ~ 90% RH, non-condensing

● Applications

General Media Converter Solution

A general media converter requires a pair of fiber optic cables for data transmission and receiving.

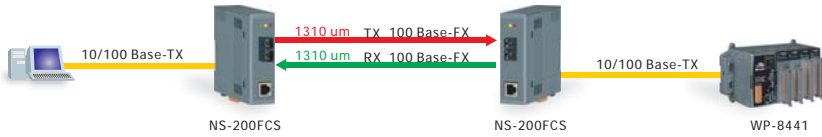

Single-Strand Fiber Converter Solution

Wavelength Division Multiplexing (WDM) supports bi-directional data transmission and receiving using dual wavelengths (1310/1550 nm) over a single strand of optical fiber.

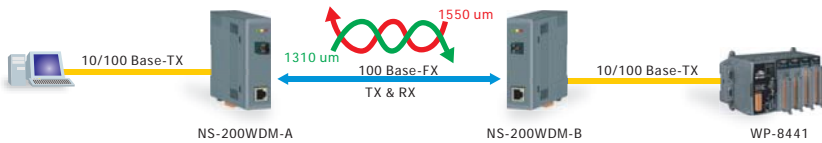

● Dimensions (Unit: mm)

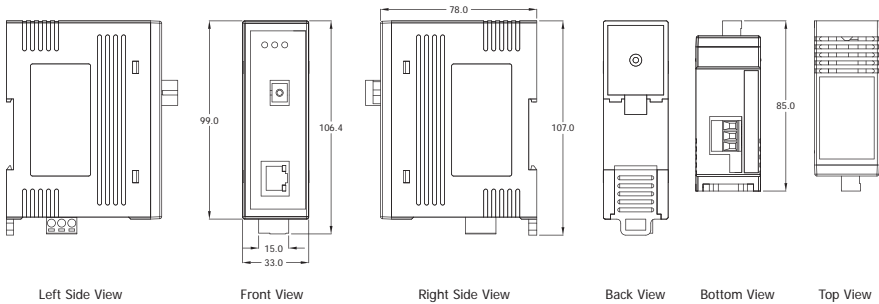

● Ordering Information

NS-200WDM-A CR	10/100 Base-TX to 100 Base-FX Single-Strand Media Converter, TX 1310 nm, RX 1550 nm, SC (RoHS)
NS-200WDM-B CR	10/100 Base-TX to 100 Base-FX Single-Strand Media Converter, TX 1550 nm, RX 1310 nm, SC (RoHS)
Important Note: You must purchase both NS-200WDM-A and NS-200WDM-B since these products work as a pair.	

● Accessories

GPSU06-6	24V/0.25A, 6 W Power Supply
KWM020-1824F	24V/0.75A, 18 W Power Supply
DIN-KA52F	24V/1.04A, 25 W Power Supply with DIN-Rail Mounting

Accessories

5

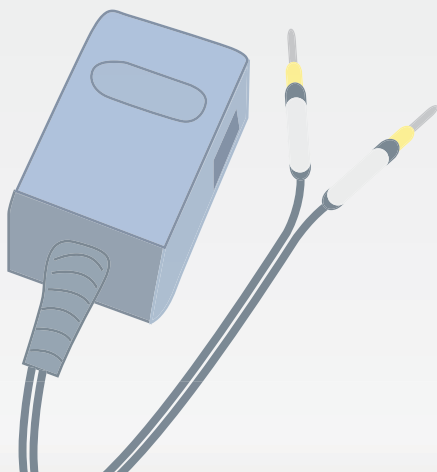

1. Cables

CA-090510

9-Pin Female D-Sub & RJ-45 Cable, 1M Cable



Ordering Information

CA-090510 | 9-Pin Female D-Sub & RJ-45 Cable, 1M Cable

RJ-45 8-pin to DB-9 cable

The wiring diagram for a CA-090510 cable is shown in Table.

RJ-45		DB-9
Pin 1	↔	Pin 6
Pin 2	↔	Pin 7
Pin 3	↔	Pin 5
Pin 4	↔	Pin 2
Pin 5	↔	Pin 3

2. Power Supplies

Selection Guide

Model Name	Input		Power	DIN-Rail Mounting	Dimensions Unit: mm (W x H x D)	Page
	Range	Frequency				
DIN-KA52F	100 ~ 250 AC	50 Hz ~ 60 Hz	24V/1.04A Max., 25 W	Yes	68 x 107 x 50	5-2
DIN-KA52F-48	100 ~ 250 AC	50 Hz ~ 60 Hz	48V/0.52A Max., 25 W	Yes	68 x 107 x 50	5-2
GPSU06U-6	100 ~ 250 AC	50 Hz ~ 60 Hz	24V/0.25A Max., 6 W	No	32 x 66 x 63	5-3
KA-52F	100 ~ 250 AC	50 Hz ~ 60 Hz	24V/1.04A Max., 25 W	No	54 x 93 x 36	5-2
KA-52F-48	100 ~ 250 AC	50 Hz ~ 60 Hz	48V/0.52A Max., 25 W	No	54 x 93 x 36	5-2
KWM020-1824F	100 ~ 250 AC	50 Hz ~ 60 Hz	24V/0.75A Max., 18 W	No	46 x 100 x 30	5-3
MDR-20-24	100 ~ 250 AC	50 Hz ~ 60 Hz	24V/1A Max., 24 W	Yes	40 x 90 x 100	5-2
MDR-60-24	100 ~ 250 AC	50 Hz ~ 60 Hz	24V/2.5A Max., 60 W	Yes	40 x 90 x 100	5-2
MDR-60-48	100 ~ 250 AC	50 Hz ~ 60 Hz	48V/1.25A Max., 60 W	Yes	40 x 90 x 100	5-2

Power Supplies with DIN-Rail Mounting

KA-52F(-48)/DIN-KA52F(-48)

24V/1.04A, 25 W Power Supply with DIN-Rail Mounting



Specifications

Models	KA-52F	DIN-KA52F	KA-52F-48	DIN-KA52F-48
Input				
Range	100 ~ 250 V _{AC}			
Frequency	50 Hz ~ 60 Hz			
Output				
Power	24 V _{DC} /1.04 A Max., 25 W		48 V _{DC} /0.52 A Max., 25 W	
Mechanical				
Dimensions (W x H x D, Unit: mm)	54 x 93 x 36	68 x 107 x 50	54 x 93 x 36	68 x 107 x 50
Installation	No-mounting	DIN-Rail Mounting	No-mounting	DIN-Rail Mounting
Environmental				
Operating Temperature	0 °C ~ +50 °C			
Storage Temperature	-20 °C ~ +85 °C			

Ordering Information

KA-52F	24 V _{DC} /1.04 A, 25 W Power Supply
DIN-KA52F	24 V _{DC} /1.04 A, 25 W Power Supply with Din-Rail Mounting
KA-52F-48	48 V _{DC} /0.52 A, 25 W Power Supply
DIN-KA52F-48	48 V _{DC} /0.52 A, 25 W Power Supply with Din-Rail Mounting

MDR-20-24/MDR-60-24/MDR-60-48

Single Output Industrial DIN-Rail Power Supply



Specifications

	MDR-20-24	MDR-60-24	MDR-60-48
Input			
Range	100 ~ 250 AC		
Frequency	50 Hz ~ 60 Hz		
Output			
Power	24 V _{DC} /1 A Max. 24 W	24 V _{DC} /2.5 A Max. 60 W	48 V _{DC} /1.25 A Max. 60 W
Mechanical			
Dimensions (W x H x D) (Unit: mm)	22.5 x 90 x 100	40 x 90 x 100	40 x 90 x 100
Installation	DIN-Rail Mounting		
Environmental			
Operating Temperature	-20 °C ~ +70 °C		
Storage Temperature	-20 °C ~ +85 °C		

Ordering Information

MDR-20-24	24V/1A, 24 W Power Supply with DIN-Rail Mounting
MDR-60-24	24V/2.5A, 60 W Power Supply with DIN-Rail Mounting
MDR-60-48	48V/1.25A, 60 W Power Supply with DIN-Rail Mounting

Power Supplies without DIN-Rail Mounting

GPSU06U-6

24V/0.25A, 6 W Power Supply



Specifications

Input	
Range	100 ~ 250 AC
Frequency	50 Hz ~ 60 Hz
Output	
Power	24 V _{DC} /0.25 A Max. 6 W
Mechanical	
Dimensions (W x H x D)	32 mm x 66 mm x 68 mm
Installation	No-mounting
Environmental	
Operating Temperature	0 °C ~ +40 °C
Storage Temperature	-20 °C ~ +85 °C

Ordering Information

GPSU06U-6	24V/0.25A, 6 W Power Supply
-----------	-----------------------------

KWM020-1824F

24V/0.75A, 18 W Power Supply



Specifications

Input	
Range	100 ~ 250 AC
Frequency	50 Hz ~ 60 Hz
Output	
Power	24 V _{DC} /0.75 A Max. 18 W
Mechanical	
Dimensions (W x H x D)	46 mm x 100 mm x 30 mm
Installation	No-mounting
Environmental	
Operating Temperature	0 °C ~ +70 °C
Storage Temperature	-40 °C ~ +85 °C

Ordering Information

KWM020-1824F	24V/0.75A, 18 W Power Supply
--------------	------------------------------

*Product
Ordering Information*

6



1. Managed Ethernet Switches

6

Product Ordering Information Managed Ethernet Switches

Model Name	Ordering Information	Page
RS-405 CR	5-Port Real-time Redundant Ring Switch (RoHS)	2-9
RS-405FC CR	Multi Mode, SC Connector, 3-Port 10/100 Base-TX + 2-Port 100 Base-FX Fiber Real-time Redundant Ring Switch (RoHS)	2-21
RS-405FCS CR	Single Mode, SC Connector, 3-Port 10/100 Base-TX + 2-Port 100 Base-FX Fiber Real-time Redundant Ring Switch (RoHS)	2-21
RS-405FT CR	Multi Mode, ST Connector, 3-Port 10/100 Base-TX + 2-Port 100 Base-FX Fiber Real-time Redundant Ring Switch (RoHS)	2-21
RS-408 CR	8-Port Real-time Redundant Ring Switch (RoHS)	2-13
RSM-405 CR	5-Port Real-time Redundant Ring Switch with Metal Casing (RoHS)	2-9
RSM-405FC CR	Multi Mode, SC Connector, 3-Port 10/100 Base-TX + 2-Port 100 Base-FX Fiber Real-time Redundant Ring Switch with Metal Casing (RoHS)	2-21
RSM-405FCS CR	Single Mode, SC Connector, 3-Port 10/100 Base-TX + 2-Port 100 Base-FX Fiber Real-time Redundant Ring Switch with Metal Casing (RoHS)	2-21
RSM-405FT CR	Multi Mode, ST Connector, 3-Port 10/100 Base-TX + 2-Port 100 Base-FX Fiber Real-time Redundant Ring Switch with Metal Casing (RoHS)	2-21
RSM-408 CR	8-Port Real-time Redundant Ring Switch with Metal Casing (RoHS)	2-13
MSM-508 CR	8-Port 10/100 Base-TX Managed Switch with Metal Casing (RoHS)	2-5
MSM-508FC CR	Multi Mode, SC Connector, 6-Port 10/100 Base-TX + 2-Port 100 Base-FX Fiber Managed Switch with Metal Casing (RoHS)	2-17
MSM-508FCS CR	Single Mode, SC Connector, 6-Port 10/100 Base-TX + 2-Port 100 Base-FX Fiber Managed Switch with Metal Casing (RoHS)	2-17
MSM-508FT CR	Multi Mode, ST Connector, 6-Port 10/100 Base-TX + 2-Port 100 Base-FX Fiber Managed Switch with Metal Casing (RoHS)	2-17

2. Unmanaged Ethernet Switches

Model Name	Ordering Information	Page
NS-205 CR	Unmanaged 5-Port Industrial Ethernet Switch (RoHS)	3-1
NS-205G CR	Unmanaged 5-Port Industrial 10/100/1000 Base-T Ethernet Switch (RoHS)	3-5
NS-205-IP67 CR	Unmanaged 5-Port Industrial Ethernet Switch with IP67 Casing (RoHS)	3-33
NS-205-IP67/DIN CR	NS-205-IP67 with DIN-Rail Mount (RoHS)	3-33
NS-205PSE CR	Unmanaged Ethernet Switch with 4-PoE Port and 1 RJ-45 Uplink (RoHS)	3-9
NS-205PSE-24 CR	Unmanaged 5-Port 10/100 Mbps PoE (PSE) Ethernet Switch; 24 V _{DC} Input (RoHS)	3-13
NS-208 CR	Unmanaged 8-Port Industrial 10/100 Base-TX Ethernet Switch (RoHS)	3-13
NS-208G CR	Unmanaged 8-Port Industrial 10/100/1000 Base-T Ethernet Switch (RoHS)	3-17
NS-208PSE CR	Unmanaged 8-Port Industrial 10/100 Mbps PoE(PSE) Ethernet Switch (RoHS)	3-25
NS-208PSE-4 CR	8-Port Industrial 10/100 Mbps Ethernet with 4-PoE (PSE) Switch (RoHS)	3-29
NS-208PSE-R CR	NS-208PSE with Conformal coating protection (RoHS)	3-25
NSM-108 CR	Unmanaged 8-Port Industrial 10/100 Base-TX Ethernet Switch (RoHS)	3-13
NSM-208G CR	Unmanaged 8-Port Industrial 10/100/1000 Base-T Ethernet Switch (RoHS)	3-17
NSM-208PSE CR	Unmanaged 8-Port Industrial 10/100 Mbps PoE(PSE) Ethernet Switch with Metal Casing (RoHS)	3-25
NSM-208PSE-4 CR	8-Port Industrial 10/100 Mbps Ethernet with 4-PoE (PSE) Switch; Metal Casing (RoHS)	3-29
NSM-208PSE-R CR	NSM-208PSE with Conformal coating protection (RoHS)	3-25
NS-205FC CR	Unmanaged 4-Port Industrial 10/100 Base-TX with 100 Base-FX Fiber Switch (RoHS)	3-21
NS-205FCS CR	Unmanaged 4-Port Industrial 10/100 Base-TX with 100 Base-FX Fiber Switch (RoHS)	3-21
NS-205FT CR	Unmanaged 4-Port Industrial 10/100 Base-TX with 100 Base-FX Fiber Switch (RoHS)	3-21
NS-205PFT CR	Multi-mode, ST Connector, 4-Port 10/100 Mbps PoE (PSE) with 1 Fiber port Switch (RoHS)	3-45
NS-205PFC CR	Multi-mode, SC Connector, 4-Port 10/100 Mbps PoE (PSE) with 1 Fiber port Switch (RoHS)	3-45
NS-205PFCS CR	Single-mode 30 Km, SC Connector, 4-Port 10/100 Mbps PoE (PSE) with 1 Fiber port Switch (RoHS)	3-45
NS-205PFCS-60 CR	Single-mode 60 Km, SC Connector, 4-Port 10/100 Mbps PoE (PSE) with 1 Fiber port Switch (RoHS)	3-45
NS-206FC CR	Unmanaged 4-Port Industrial 10/100 Base-TX with Dual 100 Base-FX Switch (RoHS)	3-25
NS-206FCS CR	Unmanaged 4-Port Industrial 10/100 Base-TX with Dual 100 Base-FX Switch (RoHS)	3-25
NS-206FT CR	Unmanaged 4-Port Industrial 10/100 Base-TX with Dual 100 Base-FX Switch (RoHS)	3-25
NS-209FC CR	Unmanaged 8-Port Industrial 10/100 Base-TX with 100 Base-FX Fiber Switch (RoHS)	3-29
NS-209FCS CR	Unmanaged 8-Port Industrial 10/100 Base-TX with 100 Base-FX Fiber Switch (RoHS)	3-29
NS-209FT CR	Unmanaged 8-Port Industrial 10/100 Base-TX with 100 Base-FX Fiber Switch (RoHS)	3-29
NSM-205FC CR	Unmanaged 4-Port Industrial 10/100 Base-TX with 100 Base-FX Fiber Switch (RoHS)	3-21
NSM-205FCS CR	Unmanaged 4-Port Industrial 10/100 Base-TX with 100 Base-FX Fiber Switch (RoHS)	3-21
NSM-205FT CR	Unmanaged 4-Port Industrial 10/100 Base-TX with 100 Base-FX Fiber Switch (RoHS)	3-21
NSM-205PSE-24V CR	Unmanaged 8-Port Industrial 10/100 Mbps PoE (PSE) Ethernet Switch with Metal Casing (RoHS)	3-45
NSM-205PFT CR	Multi-mode, ST Connector, 4-Port 10/100 Mbps PoE (PSE) with 1 Fiber port Switch; metal case (RoHS)	3-45
NSM-205PFC CR	Multi-mode, SC Connector, 4-Port 10/100 Mbps PoE (PSE) with 1 Fiber port Switch; metal case (RoHS)	3-45
NSM-205PFCS CR	Single-mode 30 Km, SC Connector, 4-Port 10/100 Mbps PoE (PSE) with 1 Fiber port Switch; metal case (RoHS)	3-45
NSM-205PFCS-60 CR	Single-mode 60 Km, SC Connector, 4-Port 10/100 Mbps PoE (PSE) with 1 Fiber port Switch; metal case (RoHS)	3-45
NSM-206FC CR	Unmanaged 4-Port Industrial 10/100 Base-TX with Dual 100 Base-FX Switch (RoHS)	3-25
NSM-206FCS CR	Unmanaged 4-Port Industrial 10/100 Base-TX with Dual 100 Base-FX Switch (RoHS)	3-25
NSM-206FT CR	Unmanaged 4-Port Industrial 10/100 Base-TX with Dual 100 Base-FX Switch (RoHS)	3-25
NSM-209FC CR	Unmanaged 8-Port Industrial 10/100 Base-TX with 100 Base-FX Fiber Switch (RoHS)	3-29
NSM-209FCS CR	Unmanaged 8-Port Industrial 10/100 Base-TX with 100 Base-FX Fiber Switch (RoHS)	3-29
NSM-209FT CR	Unmanaged 8-Port Industrial 10/100 Base-TX with 100 Base-FX Fiber Switch (RoHS)	3-29

3. Media Converters

6

Product Ordering Information

Media Converters & Accessories

Model Name	Ordering Information	Page
NS-200FC CR	Industrial 10/100 Base-TX to 100 Base-FX Media (Multi Mode) Converter (RoHS)	4-1
NS-200FCS CR	Industrial 10/100 Base-TX to 100 Base-FX Media (Single Mode) Converter (RoHS)	4-1
NS-200FT CR	Industrial 10/100 Base-TX to 100 Base-FX Media (Multi Mode) Converter (RoHS)	4-1
NS-200G CR	1000 Base-T to 1000 Base-SX/LX Media Converter Without SPF Module (RoHS)	4-5
NS-200GSX CR	1000 Base-T to 1000 Base-SX Multi Mode Media Converter (RoHS)	4-5
NS-200GLX CR	1000 Base-T to 1000 Base-LX Single Mode Media Converter (RoHS)	4-5
NS-200WDM-A CR	10/100 Base-TX to 100 Base-FX Single-Strand Media Converter, TX 1310 nm, RX 1550 nm, SC (RoHS)	4-7
NS-200WDM-B CR	10/100 Base-TX to 100 Base-FX Single-Strand Media Converter, TX 1550 nm, RX 1310 nm, SC (RoHS)	4-7
Important Note: You must purchase both NS-200WDM-A and NS-200WDM-B since these products work as a pair.		

4. Accessories

Model Name	Ordering Information	Page
CA-090510	9-Pin Female D-Sub & RJ-45 Cable, 1M Cable	5-1
DIN-KA52F	24V/1.04A, 25 W Power Supply with Din-Rail Mounting	5-2
DIN-KA52F-48	48 V _{DC} /0.52 A, 25 W Power Supply with Din-Rail Mounting	5-2
GPSU06U-6	24V/0.25A, 6 W Power Supply	5-3
KA-52F	24 V _{DC} /1.04 A, 25 W Power Supply	5-2
KA-52F-48	48 V _{DC} /0.52 A, 25 W Power Supply	5-2
KWM020-1824F	24V/0.75A, 18 W Power Supply	5-3
MDR-20-24	24V/1A, 24 W Power Supply with DIN-Rail Mounting	5-2
MDR-60-24	24V/2.5A, 60 W Power Supply with DIN-Rail Mounting	5-2
MDR-60-48	48V/1.25A, 60 W Power Supply with DIN-Rail Mounting	5-2

Related Products

1. CAN Bus to Ethernet Gateway
2. Serial Device to Ethernet Gateway
3. Wireless ZigBee Series

7

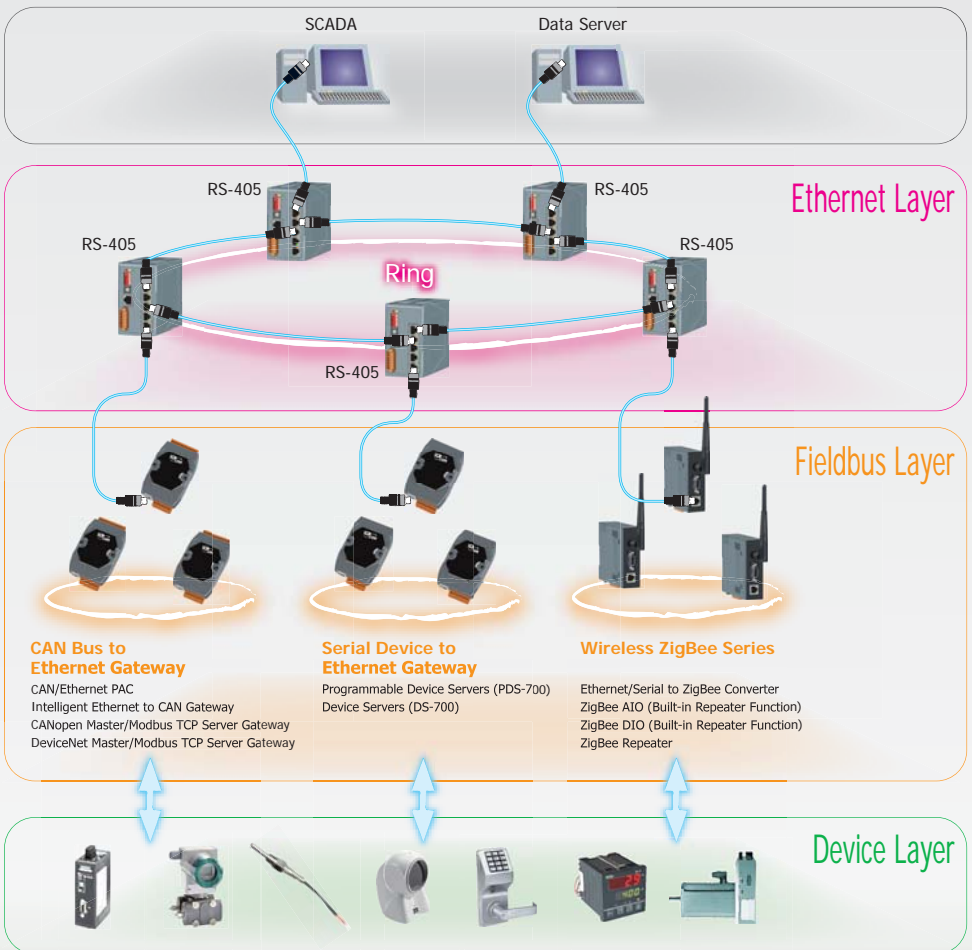

CAN Bus to Ethernet Gateway

CAN/Ethernet PAC
 Intelligent Ethernet to CAN Gateway
 CANopen Master/Modbus TCP Server Gateway
 DeviceNet Master/Modbus TCP Server Gateway

Serial Device to Ethernet Gateway

Programmable Device Servers (PDS-700)
 Device Servers (DS-700)

Wireless ZigBee Series

Ethernet/Serial to ZigBee Converter
 ZigBee AIO (Built-in Repeater Function)
 ZigBee DIO (Built-in Repeater Function)
 ZigBee Repeater

Device Layer

1. CAN Bus to Ethernet Gateway

7

Related Products

CAN Bus to Ethernet Gateway

CAN bus Common Features

- Compatible with CAN specification 2.0A and 2.0B
- Fully compliant with the ISO-11898-2 standard
- Support several kinds of bauds from 10K to 1 Mbps
- 2500 V_{rms} photo couple isolation on the CAN bus
- Jumper or DIP switch for 120 Ω terminal resistor of CAN bus
- The max baud is 1 Mbps and the max length is 5000 m
- DeviceNet/CANopen/J1939...applications

The relation of CAN bus Baud and Length

Baud (bit/sec)	Ideal Bus Length (m)
1M	25
800K	50
500K	100
250K	250
125K	500
50K	1000
20K	2500
10K	5000

CAN/Ethernet PAC

μPAC-7186EXD-CAN

μPAC-7186 CAN bus series Programmable Automation Controller

The μPAC-7186EXD-CAN PACs (Programmable Automation Controller) are powered by 80186-80 MHz CPU with 512K bytes of static RAM, and 512K bytes of Flash memory with CAN, RS-232, RS-485 and Ethernet port.

Features

- High reliability in harsh environment
- Embedded MiniOS7, anti-virus
- Built-in watchdog timer (WDT)
- Ethernet Protocols: TCP, UDP, IP, ICMP, ARP
- Faster 10/100M Ethernet port
- Support virtual COM technology
- Free easy-to-use software development toolkits
- Modbus protocol
- Support DeviceNet/CANopen/J1939...CAN applications



Applications

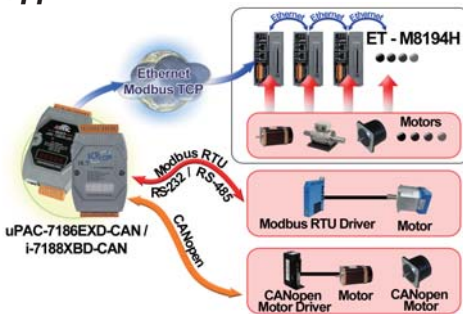

Wiring

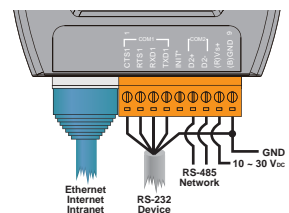
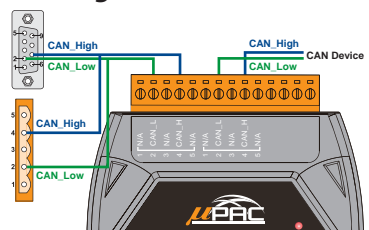

Ordering Information

μPAC-7186EXD-CAN	Programmable Automation Controller with two series communication port (RS-232/RS-485), one CAN port, one Ethernet port, 7-segment Display, 4 programmable LEDs, 512K flash ,512K SRAM, developing tool kit, MiniOS7.
------------------	--

Intelligent Ethernet to CAN Gateway



I-7540D

Internet communication controller with one CAN bus, one RS-232, one RS-485 and one Ethernet

I-7540D is a CAN-Ethernet Gateway to control networked communication between CAN and Ethernet. It also can be used as a Ethernet to RS-232/485 devices Server.

- High reliability in harsh environment
- Built-in 80186-80 MHz CPU
- Built-in watchdog timer (WDT)
- COM driver support interrupt & 1K QUEUE Input & Output buffer
- Support one RS-232 port, one RS-485 port and one CAN port
- Support virtual COM technology
- 2500 V_{rms} photo-isolation protection on CAN side
- TCP/UDP protocol transmission between CAN bus and Ethernet
- Free CAN monitor tools

Ordering Information

I-7540D	Internet communication controller with one CAN bus, one RS-232, one RS-485 and one Ethernet
---------	---

CANopen Master/Modbus TCP Server Gateway



GW-7433D

Internet communication controller with one CAN bus, one RS-232, one RS-485 and one Ethernet

- Programmable standard CANopen baud, such as 10 Kbps, 20 Kbps, 50 Kbps
- 125 Kbps, 250 Kbps, 500 Kbps, 800 Kbps and 1 Mbps
- Support maximum 50 TxPDO, 50 RxPDO, 15 SDO to SDO server
- Support Communication Object: TxPDO, RxPDO, and server SDO
- Support on-line configure CANopen slaves
- Communicate with CANopen slaves automatically when GW-7433D boots up
- Allow 5 Modbus/TCP masters to access GW-7433 simultaneously
- CANopen Version: DS301 V4.01
- Device Profile: DSP-401 v2.0

Ordering Information

GW-7433D	Modbus/TCP server to CANopen master Gateway
----------	---

DeviceNet Master/Modbus TCP Server Gateway



I-7243D

Modbus/TCP server to DeviceNet master Gateway

- Programmable DeviceNet Master MAC 1D
- Programmable DeviceNet transfer-rate 125K, 250K, 500K
- Supports maximum DeviceNet devices up to 63
- Predefined Master/Slave Connection Set
- The maximum Fragment number is (Input/Output) up to 64
- Supports I/O Operation Mode: Poll, Bit-Strobe and Change Of State/Cyclic
- Supports on-line adding device into and removing device from network
- Supports boot-up auto communicate with slave devices
- Converts single Modbus/TCP to multi Modbus/RTU, setting by Utility
- Supports VxComm technique for every COM ports of controllers, setting by Utility
- Allowed multi-client (or master) access simultaneously
- Supports one Poll, one Bit-Strobe, one COS, one Cyclic IO connection for each DeviceNet device when connected with this module

Ordering Information

I-7243D	Modbus/TCP server to DeviceNet master Gateway
---------	---

2. Serial Device to Ethernet Gateway

Programmable Device Servers

7

Related Products Serial Device to Ethernet Gateway



Liberate your serial devices to modern world.
Programmable Device Server

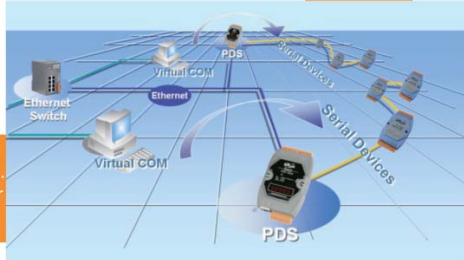

Connect every of your serial devices into Ethernet. PLCs, bar code readers, RFID readers, meters, motion controllers and many of other serial devices have been widely-used for years in every corner of the world. To make the most use of recorded data and to achieve remote control conveniently, we integrate those serial devices with modern networks, and the key to do these counts on the PDS. All PDS series feature programmable ability that makes even your various ideas into reality!

Easy Serial Device Networking with "transparency"

The most intuitive and easiest way to remotely control serial devices is to access serial devices transparently via network with no software modification required. PDS product lines offer two transparent applications:

- TCP/IP Socket Programming: By TCP/IP Socket Programming, it could exchange information with specific PDS serial port and talk to serial devices directly.
- Virtual COM Ports: ICP DAS developed a specific function called "Virtual COM" that simulates PDS serial ports as fixed PC COM ports. Virtual COM ports appear to the system and applications like real ones, the users could immediately enjoy the convenience brought by networking.





VxComm driver & utility
Where remote serial devices become part of your PC

VxComm Driver creates virtual COM port(s) on Windows NT 4.0/2000/XP/2003/Vista32 and maps them to the remote serial port(s) of the PDS-700/DS-700 series. The user's serial client programs need only to change to the virtual COM port to get the access of serial devices that are allocated in the Internet or Ethernet network via the PDS-700/DS-700 series.
Easy serial devices networking just in minutes.

Programmable Enhanced "Device Servers"

The programmable feature of PDS series products makes it possible to effectively build in exclusive protocols and exclusive communication mechanism of complex applications in PDS. This provides the following advantages:

- **Effective network transmission:** Place your customized software on PDS to directly perform processions locally. The effective data and information could be sent back to PC periodically according to schedules planned in advance and devices could work independently on-site even when not connecting to a network. Therefore, the design of system could be much more flexible. It also reduces the need to rely on network, which is an inevitable factor for conventional DS (Device Server) - it has to keep on "talking" to PC via network to ensure status maintains transparency.
- **Previous development effort could be duplicated:** Along with serial devices, you could place your customized or value-add software on PDS to implement an intelligent Ethernet controller. This controller could be used in applications for next projects. It dramatically reduce programming job. In addition, your value-add software is embedded in PDS, if a computer system undergoes hardware replacement or upgrade; it doesn't need to consider incompatible problems, therefore reduce system maintenance work.

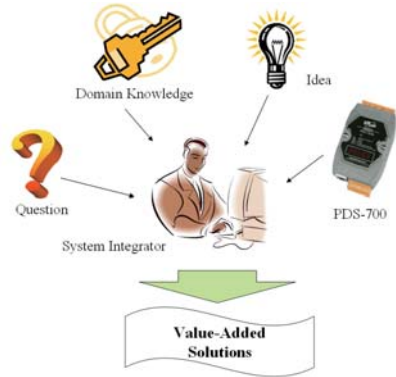

Virtual I/O Highly Integrates On-Site Messages

I/O acquisition is very important when performing on-site integration, along with DCON utility provided by ICP DAS, the RS-485 of PDS could connect to I-7000 series products to offer abundant I/O modules for various purposes. For easier on-site integration operations, partial PDS models also provide Digital I/O, which is also supported by DCON utility or other DCON client programs.



"Virtual I/O" is the extension of "Virtual COM" technology that simulates PDS's digital I/Os control as a virtual COM port (Port I/O) application on PC. And since now, you are able to access PDS's digital I/Os by DCON protocol through the virtual COM port. Besides, DCON utility also supports configuring PDS's digital I/Os through the help of "Virtual I/O" technology. So you can diagnose PDS's digital I/Os and complete the I/Os application in a convenient way.

PDS-700 Programmable Device Servers

7

Related Products

Serial Device to Ethernet Gateway



Features

- Networkable serial devices
- "Virtual COM" extend COM ports
- Powerful programmable device server
- "Virtual I/O" integrates on-site I/O
- Watchdog timer suitable for use in harsh environments
- 10/100 Base-TX Ethernet Controller (Auto-negotiating, auto MDI/MDI-X, LED indicator)
- Power reverse polarity protection circuit
- RS-485 port ESD protection circuit
- Self-tuner ASIC controller on RS-485 port
- Enables download of programs from PC
- 5-digit display (only for version with display)
- IP67 against the intrusion of dust, water, etc (IP67 version)
- RoHS compliant with No Halogen

Specifications

CPU	80186-80 MHz
Ethernet	10/100 Base-TX
SRAM/Flash	512 KB/512 KB
COM1	5-wire RS-232 (RXD, TXD, CTS, RTS, GND)
UART	16c550 or compatible
Baud rate	115200 bps Max.
D/I	Source, Dry Type, L: 0 ~ 1V, H: 3.5 ~ 30V
D/O	Open Collector, Sink/NPN, 30V/100 mA Max.
Display	7-segment LED display for D version
Frame GND	Yes
Mounting	DIN-Rail Mounting

Selection Guide

Model	DI/DO	COM1	COM2	COM3	COM4	COM5	COM6	COM7	COM8
PDS-720 PDS-720D	-	5-wire RS-232	2-wire RS-485	-	-	-	-	-	-
PDS-721 PDS-721D	6/7	5-wire RS-232	2-wire RS-485	-	-	-	-	-	-
PDS-732 PDS-732D	4/4	5-wire RS-232	2-wire RS-485	5-wire RS-232	-	-	-	-	-
PDS-734 PDS-734D	4/4	5-wire RS-232	2-wire RS-485	4-wire RS-422	-	-	-	-	-
PDS-742 PDS-742D	-	5-wire RS-232	2-wire RS-485	5-wire RS-232	9-wire RS-232	-	-	-	-
PDS-742-IP67	-	5-wire RS-232	2-wire RS-485	5-wire RS-232	5-wire RS-232	-	-	-	-
PDS-743 PDS-743D	4/4	5-wire RS-232	2-wire RS-485	3-wire RS-232	3-wire RS-232	-	-	-	-
PDS-752 PDS-752D	-	5-wire RS-232	2-wire RS-485	5-wire RS-232	5-wire RS-232	5-wire RS-232	-	-	-
PDS-755 PDS-755D	-	5-wire RS-232	2-wire RS-485	2-wire RS-485	2-wire RS-485	2-wire RS-485	-	-	-
PDS-762 PDS-762D	1/2	5-wire RS-232	2-wire RS-485	3-wire RS-232	3-wire RS-232	3-wire RS-232	3-wire RS-232	-	-
PDS-782 PDS-782D	-	5-wire RS-232	2-wire RS-485	3-wire RS-232	3-wire RS-232	3-wire RS-232	3-wire RS-232	3-wire RS-232	3-wire RS-232
PDS-782-25 PDS-782D-25	-	5-wire RS-232	2-wire RS-485	3-wire RS-232	3-wire RS-232	3-wire RS-232	3-wire RS-232	3-wire RS-232	3-wire RS-232

PDS-700D = PDS-700 + 7-Seg. LED Display



PDS-732/PDS-732D



PDS-732: 3-Port Programmable Device Server with DI/DO

PDS-732D: PDS-732 with LED Display

- Ethernet: 10/100 Base-TX
- COM1: 5-Wire RS-232
- COM2: 2-Wire RS-485
- COM3: 5-Wire RS-232
- D/O: 4-Channel, Sink/NPN, 30V/100 mA Max.
- D/I: 4-Channel, Source, Dry Type,
L: 0 V_{DC} ~ +1 V_{DC}, H: +3.5 V_{DC} ~ +30 V_{DC}

PDS-742/PDS-742D



PDS-742: 4-Port Programmable Device Server

PDS-742D: PDS-742 with LED Display

- Ethernet: 10/100 Base-TX
- COM1: 5-Wire RS-232
- COM2: 2-Wire RS-485
- COM3: 5-Wire RS-232
- COM4: 9-Wire RS-232

PDS-720/PDS-720D



PDS-720: 2-Port Programmable Device Server
PDS-720D: PDS-720 with LED Display

- Ethernet: 10/100 Base-TX
- COM1: 5-Wire RS-232
- COM2: 2-Wire RS-485

PDS-721/PDS-721D



PDS-721: 2-Port Programmable Device Server with DI/DO

PDS-721D: PDS-721 with LED Display

- Ethernet: 10/100 Base-TX
- COM1: 5-Wire RS-232
- COM2: 2-Wire RS-485
- D/O: 7-Channel, Sink/NPN, 30V/100 mA Max.
- D/I: 6-Channel, Source, Dry Type,
L: 0 V_{DC} ~ +1 V_{DC}, H: +3.5 V_{DC} ~ +30 V_{DC}

PDS-734/PDS-734D



PDS-734: 3-Port Programmable Device Server with DI/DO

PDS-734D: PDS-734 with LED Display

- Ethernet: 10/100 Base-TX
- COM1: 5-Wire RS-232
- COM2: 2-Wire RS-485
- COM3: 4-Wire RS-422
- D/O: 4-Channel, Sink/NPN, 30V/100 mA Max.
- D/I: 4-Channel, Source, Dry Type,
L: 0 V_{DC} ~ +1 V_{DC}, H: +3.5 V_{DC} ~ +30 V_{DC}

PDS-743/PDS-743D



PDS-743: 4-Port Programmable Device Server with DI/DO

PDS-743D: PDS-743 with LED Display

- Ethernet: 10/100 Base-TX
- COM1: 5-Wire RS-232
- COM2: 2-Wire RS-485
- COM3-4: 3-Wire RS-232
- D/O: 4-Channel, Sink/NPN, 30V/100 mA Max.
- D/I: 4-Channel, Source, Dry Type,
L: 0 V_{DC} ~ +1 V_{DC}, H: +3.5 V_{DC} ~ +30 V_{DC}

PDS-752/PDS-752D



PDS-752: 5-Port Programmable Device Server
 PDS-752D: PDS-752 with LED Display

- Ethernet: 10/100 Base-TX
- COM1: 5-Wire RS-232
- COM2: 2-Wire RS-485
- COM3~5: 5-Wire RS-232

PDS-762/PDS-762D



PDS-762: 6-Port Programmable Device Server with DI/DO
 PDS-762D: PDS-762 with LED Display

- Ethernet: 10/100 Base-TX
- COM1: 5-Wire RS-232
- COM2: 2-Wire RS-485
- COM3~6: 3-Wire RS-232
- D/O: 2-Channel, Sink/NPN, 30V/100 mA Max.
- D/I: 1-Channel, Source, Dry Type,
 L: 0 V_{DC} ~ +1 V_{DC}, H: +3.5 V_{DC} ~ +30 V_{DC}

Available Soon



Available Soon



PDS-755/PDS-755D



PDS-755: 5-Port Programmable Device Server
 PDS-755D: PDS-755 with LED Display

- Ethernet: 10/100 Base-TX
- COM1: 5-Wire RS-232
- COM2: 2-Wire RS-485
- COM3~5: 2-Wire RS-485

PDS-782/PDS-782D



PDS-782: 8-Port Programmable Device Server
 PDS-782D: PDS-782 with LED Display

- Ethernet: 10/100 Base-TX
- COM1: 5-Wire RS-232
- COM2: 2-Wire RS-485
- COM3~8: 3-Wire RS-232

PDS-742-IP67

4-Port Programmable Device Server with IP67 casing

- Ethernet: 10/100 Base-TX
- COM1: 5-Wire RS-232 (8-Pin RJ-45)
- COM2: 2-Wire RS-485 (8-Pin RJ-45)
 with 2500 Vrms isolation
- COM3: 5-Wire RS-232 (8-Pin RJ-45)
- COM4: 5-Wire RS-232 (8-Pin RJ-45)

PDS-782-25/PDS-782D-25

PDS-782-25: 8-Port Programmable Device Server
 PDS-782D-25: PDS-782-25 with LED Display

- Ethernet: 10/100 Base-TX
- COM1: 5-Wire RS-232
- COM2: 2-Wire RS-485
- COM3~8: 3-Wire RS-232 (Male DB-9)

Ordering Information	
PDS-720 PDS-720D	Programmable Device Server with 1-Port RS-232 and 1-Port RS-485 PDS-720 with LED display
PDS-721 PDS-721D	Programmable Device Server with 1-Port RS-232, 1-Port RS-485, 6-ch D/I and 7-ch D/O PDS-721 with LED display
PDS-732 PDS-732D	Programmable Device Server with 2-Port RS-232, 1-Port RS-485, 4-ch D/I and 4-ch D/O PDS-732 with LED display
PDS-734 PDS-734D	Programmable Device Server with 1-Port RS-232, 1-Port RS-485, 1-Port RS-422, 4-ch D/I and 4-ch D/O PDS-734 with LED display
PDS-742 PDS-742D	Programmable Device Server with 3-Port RS-232 and 1-Port RS-485 PDS-742 with LED display
PDS-742-IP67	Programmable Device Server with 3-Port RS-232, 1-Port RS-485 and IP67 casing
PDS-743 PDS-743D	Programmable Device Server with 3-Port RS-232, 1-Port RS-485, 4-ch D/I and 4-ch D/O PDS-743 with LED display
PDS-752 PDS-752D	Programmable Device Server with 4-Port RS-232 and 1-Port RS-485 PDS-752 with LED display
PDS-755 PDS-755D	Programmable Device Server with 1-Port RS-232 and 4-Port RS-485 PDS-755 with LED display
PDS-762 PDS-762D	Programmable Device Server with 5-Port RS-232, 1-Port RS-485, 1-ch D/I and 2-ch D/O PDS-762 with LED display
PDS-782 PDS-782D	Programmable Device Server with 7-Port RS-232 and 1-Port RS-485 PDS-782 with LED display
PDS-782-25 PDS-782D-25	Programmable Device Server with 7-Port RS-232 and 1-Port RS-485 PDS-782-25 with LED display

DS-700 Device Servers

Selection Guide



Model	DI/DO	COM1	COM2	COM3	COM4	COM5	COM6	COM7	COM8
DS-712	-	5-wire RS-232	-	-	-	-	-	-	-
DS-715	-	2-wire RS-485	-	-	-	-	-	-	-
		4-wire RS-422							



DS-712



1-Port RS-232 Device Server
(Non-Programmable)



-  Ethernet: 10/100 Base-TX
-  COM1: 5-Wire RS-232



DS-715



1-Port RS-422/485 Device Server
(Non-Programmable)

-  Ethernet: 10/100 Base-TX
-  COM1: 4-Wire RS-422 or 2-Wire RS-485
(2000 V_{DC} Isolation)

Ordering Information	
DS-712	Device Server with 1-Port RS-232
DS-715	Device Server with 1-Port RS-422/RS-485

3. Wireless ZigBee Series

7

Ethernet/Serial to ZigBee Converter

Related Products Wireless ZigBee Series

NEW

ZB-2570
ZB-2571



NEW

ZB-2550
ZB-2551



ZB-2570/ZB-2571

ZB-2570/ZB-2571 is an Ethernet/RS-485/RS-232 to ZigBee network converter. It enables Ethernet/RS-232/485 devices to be wirelessly and easily connected to a new or existing system.

ZB-2570 is a net Host and ZB-2571 is a net Slave. It also supports various data formats and baud rates that can be configured via a Windows-based GUI utility. The ZB-2570/ZB-2571 can implement an ad-hoc, star or mesh network topology.

In some existing systems that use an Ethernet/RS-485/RS-232 network, it is sometimes difficult to extend the new devices due to building structure issues, wiring problems or other reasons. The ZB-2570/ZB-2571 can be easily added to an existing system in order to extend your network.

ZB-2550/ZB-2551

We also provide the ZB-2550 (Host) and the ZB-2551 (Slave) converters that only have RS-232/RS-485 interfaces.

Specifications	
RF Channels	16
Receive Sensitivity	-102 dBm
Transmit Power	12 dBm
Data Encryption	AES-CTR
Network Topology Support	Star, Mesh and cluster tree
Certification	TUV
Antenna	2.4 GHz, 3 dBi Omni-Directional antenna

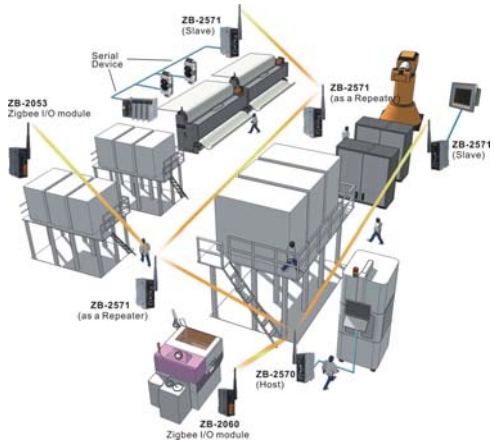

Ordering Information

ZB-2550 CR	RS-485/RS-232 to ZigBee Converter (Host) (RoHS)
ZB-2550/S CR	RS-485/RS-232 to ZigBee Converter (Host) (RoHS) + GPSU06U-6 (Power Supply)
ZB-2551 CR	RS-485/RS-232 to ZigBee Converter (Slave) (RoHS)
ZB-2551/S CR	RS-485/RS-232 to ZigBee Converter (Slave) (RoHS) + GPSU06U-6 (Power Supply)
ZB-2570 CR	Ethernet/RS-485/RS-232 to ZigBee Converter (Host) (RoHS)
ZB-2570/S CR	Ethernet/RS-485/RS-232 to ZigBee Converter (Host) (RoHS) + GPSU06U-6 (Power Supply)
ZB-2571 CR	Ethernet/RS-485/RS-232 to ZigBee Converter (Slave) (RoHS)
ZB-2571/S CR	Ethernet/RS-485/RS-232 to ZigBee Converter (Slave) (RoHS) + GPSU06U-6 (Power Supply)

ZigBee AIO (Built-in Repeater Function)

Available Soon



ZB-2015

Wireless 6-channel RTD Input Module with 3-wire RTD Lead Resistance Elimination

Analog Input

- Input Channels: 6
- Input Type: RTD
- Wire Connection: 2 or 3 Wires
- RTD Type: Pt100, Pt1000, Ni120, Cu100, Cu1000
- Resolution: 16-bit
- Sampling Rate: 12 Samples/Sec. (Total)
- Accuracy: +/-0.05%
- Voltage Input Impedance: >1 M Ω
- Open Wire Detection: Yes
- Individual Channel Configurable: Yes
- 3-wire RTD Lead Resistance Elimination: Yes
- ESD Protection: +/-4 kV Contact for Each Terminal, and +/-8 kV Air for Random Point
- Intra-module Isolation, Field to Logic: 3000 V_{DC}
- Power Consumption: 1.5 W

Available Soon



ZB-2017

Wireless 8-channel Analog Input Module with High Voltage Protection

Analog Input

- Input Channels: 8 Differential
- Input Type: +/-10 V, +/-5 V, +/-1 V, +/-500 mV, +/-150 mV, -20 mA ~ +20 mA (Requires Optional External 125 Ω Resistor)
- Resolution: 16-bit/12-bit
- Sampling Rate: Normal Mode: 16-bit, 10 Samples/Sec. (Total)
Fast Mode: 12-bit, 60 Sample/Sec. (Total)
- Accuracy: Normal Mode: +/-0.1% of FSR
Fast Mode: +/-0.5% of FSR
- Zero Drift: +/-20 μ V/ $^{\circ}$ C
- Span Drift: +/-25 ppm/ $^{\circ}$ C
- Common Mode Rejection: 86 dB
- Normal Mode Rejection: 100 dB
- Input Impedance: >1 M Ω
- Over Voltage Protection: 240 V_{rms}
- ESD Protection: +/-4 kV Contact for Each Terminal
- Intra-module Isolation, Field to Logic: 3000 V_{DC}
- Power Consumption: 1.5 W

Available Soon



ZB-2017C

Wireless 8-channel Current Input Module with High Common Voltage Protection

Analog Input

- **Input Channels:** 8 Differential
- **Input Type:** +/-20 mA, 0~20 mA, 4~20 mA
- **Resolution:** 16-bit (Normal Mode)/12-bit (Fast Mode)
- **Sampling Rate:** Normal Mode: 16-bit, 10 Samples/Sec. (Total)
Fast Mode: 12-bit, 60 Sample/Sec. (Total)
- **Accuracy:** +/-0.1% (Normal Mode)
+/-0.5% (Fast Mode) or better
- **Band Width:** 15.7 Hz (Normal Mode)/78.7 Hz (Fast Mode)
- **Zero Drift:** +/-20 μ V/°C
- **Span Drift:** +/-25 ppm/°C
- **Input Impedance:** 125 Ω
- **Common Mode Rejection:** 86 dB min.
- **Normal Mode Rejection:** 100 dB
- **Common Voltage:** +/-200 V_{DC}
- **ESD Protection:** +/-4 kV Contact for Each Terminal
- **Intra-module Isolation, Field to Logic:** 3000 V_{DC}
- **Power Consumption:** 1.5 W

Available Soon



ZB-2018

Wireless 8-channel Analog Input Module with High Voltage Protection

Analog Input

- **Input Channels:** 8 Differential
- **Input Type:** +/-15 mV, +/-50 mV, +/-100 mV, +/-500 mV,
+/-1V, +/-2.5 V, +/-20 mA (Requires Optional
External 125 Ω Resistor)
Thermocouple Type J, K, T, E, R, S, B, N, C, L, M
- **Resolution:** 16-bit
- **Sampling Rate:** 10 Samples/Sec. (Total)
- **Accuracy:** +/-0.1%
- **Input Impedance:** 1 M Ω
- **Over Voltage Protection:** 240 V_{rms}
- **Open Thermocouple Detection:** Yes
- **ESD Protection:** +/-4 kV Contact for Each Terminal
- **Intra-module Isolation, Field to Logic:** 3000 V_{DC}
- **Power Consumption:** 1.5 W

Available Soon



ZB-2024

Wireless 4-channel Voltage/Current Output Module

Analog Output

- **Output Channels:** 4
- **Output Type:** +/-10 V_{DC}, +/-5 V_{DC}, 0 V_{DC} ~ +5 V_{DC}, 0 V_{DC} ~ +10 V_{DC},
0 mA ~ 20 mA, 4 mA ~ 20 mA
- **Resolution:** 12-bit
- **Accuracy:** +/-0.1% of FSR
- **Zero Drift:** Voltage: +/-30 μ V/°C
- **Span Drift:** +/-25 ppm/°C
- **Programmable Output Slope:** 0.0625 ~ 512 V/Sec.
- **Voltage Output Capability:** 10 mA @ 10 V
- **Current Load Resistor:** 500 Ω
- **Power-Up and Safe Value:** Yes
- **Intra-module Isolation, Field to Logic:** 2500 V_{DC}
- **Power Consumption:** 1.5 W

Available Soon



ZB-2026

Wireless 4-channel Voltage Input, 2-channel Voltage Output and 2-channel Digital Output

Analog Input

- Input Channels: 4 Differential
- Input Type: $\pm 10\text{ V}$, $\pm 5\text{ V}$, $\pm 1\text{ V}$, $\pm 500\text{ mV}$, $\pm 150\text{ mV}$, $-20\text{ mA} \sim +20\text{ mA}$
(Requires Optional External $125\ \Omega$ Resistor)
- Resolution: 16-bit (Normal Mode)/12-bit (Fast Mode)
- Sampling Rate: Normal Mode: 16-bit, 10 Samples/Sec. (Total)
Fast Mode: 12-bit, 60 Sample/Sec. (Total)
- Accuracy: $\pm 0.1\%$ (Normal Mode)
 $\pm 0.5\%$ (Fast Mode) or better

Analog Output

- Output Channels: 2
- Output Type: $0\text{ V}_{\text{DC}} \sim +10\text{ V}_{\text{DC}}$
- Resolution: 12-bit
- Accuracy: $\pm 0.1\%$ of FSR
- Programmable Output Slope: $0.0625 \sim 512\text{ V/Sec.}$
- Voltage Output Capability: $10\text{ mA @ } 10\text{ V}$
- Power-Up and Safe Value: Yes

Digital Output

- Output Channels: 2 (Sink)
- Output Type: Isolated Open Collector
- Max Load Current: 700 mA/Channel
- Load Voltage: $5\text{ V}_{\text{DC}} \sim 50\text{ V}_{\text{DC}}$

Ordering Information

ZB-2015 CR	Wireless 6-channel RTD Input Module with 3-wire RTD Lead Resistance Elimination (RoHS)
ZB-2017 CR	Wireless 8-channel Analog Input Module with High Voltage Protection (RoHS)
ZB-2017C CR	Wireless 8-channel Current Input Module with High Common Voltage Protection (RoHS)
ZB-2018 CR	Wireless 8-channel Analog Input Module with High Voltage Protection (RoHS)
ZB-2024 CR	Wireless 4-channel Voltage/Current Module (RoHS)
ZB-2026 CR	Wireless 4-channel Voltage Input, 2-channel Voltage Output and 2-channel Digital Output

Important Note: The ZigBee AIO modules need a ZB-2570 to coordinate the data transmission route, please remember to also order a ZB-2570 when you purchase the ZigBee AIO products.

ZigBee DIO (Built-in Repeater Function)



ZB-2042

Wireless 14-channel Isolated Digital Output Module

Digital Output

- Output Channels: 14 (Sink)
- Output Type: Isolated Open Collector
- Max Load Current: 700 mA/Channel
- Load Voltage: $5\text{ V}_{\text{DC}} \sim 50\text{ V}_{\text{DC}}$
- ESD Protection: $\pm 4\text{ kV}$ Contact for Each Terminal
- Intra-module Isolation, Field to Logic: $3750\text{ V}_{\text{rms}}$
- Power Consumption: 1.7 W

NEW

ZB-2043

Wireless 4-channel PhotoMOS Relay Output and 4-channel Open Collector Output Module

Relay Output

- **Output Channels:** 4
- **Output Type:** PhotoMOS Relay, Form A
- **Load Voltage:** 60 V_{DC}/V_{AC}
- **Max. Load Current:**
 - 60V/1.0A (Operating Temperature: -25 °C ~ +40 °C)
 - 60V/0.8A (Operating Temperature: +40 °C ~ +60 °C)
 - 60V/0.7A (Operating Temperature: +60 °C ~ +75 °C)
- **Turn On Time:** 5.0 ms
- **Turn Off Time:** 0.5 ms

Digital Output

- **Output Channels:** 4 (Sink)
- **Output Type:** Isolated Open Collector
- **Max Load Current:** 700 mA/Channel
- **Load Voltage:** +5 V_{DC} ~ +50 V_{DC}
- **ESD Protection:** +/-4 kV Contact for Each Terminal
- **Intra-module Isolation, Field to Logic:** 3750 V_{rms}
- **Power Consumption:** 1.5 W

NEW

ZB-2052

Wireless 14-channel Isolated Digital Input Module

Digital Input

- **Input Channels:** 14
- **Wet Contact (Sink/Source):** On Voltage Level: +3.5 V_{DC} ~ +30 V_{DC}
Off Voltage Level: +1 V_{DC} Max.
- **Input Impedance:** 3 k Ω , 0.33 W
- **Counter:**
 - Channels:** 14
 - Max. Counts:** 16-bit (65535)
 - Min. Pulse Width:** 5 ms
 - Max. Input Frequency:** 100 Hz
- **Intra-module Isolation, Field to Logic:** 3750 V_{rms}
- **ESD Protection:** +/-4 kV Contact for Each Terminal
- **Power Consumption:** 1.7 W

NEW

ZB-2053

Wireless 8-channel Isolated Digital Input Module with 16-bit Counters

Digital Input

- **Input Channels:** 8
- **Input Type:** Isolation, Wet Contact (Sink/Source)
- **Input Level:** On Voltage Level: +3.5 V_{DC} ~ +30 V_{DC}
Off Voltage Level: +1 V_{DC} Max.
- **Input Impedance:** 3 k Ω , 0.33 W
- **Intra-module Isolation, Field to Logic:** 3000 V_{DC}
- **ESD Protection:** +/-4 kV Contact for Each Terminal
- **EFT Protection:** +/-4 kV for Power Input
- **Surge Protection:** +/-3 kV for Power Input
- **Power Consumption:** 1 W Max.

NEW



ZB-2060

Wireless 6-channel Isolated Digital Input and 4-channel Relay Output Module

Digital Input

- Input Channels: 6
- Input Type: Isolation, Wet Contact (Sink/Source)
- Input Level: On Voltage Level: +3.5 V_{DC} ~ +30 V_{DC}
Off Voltage Level: +1 V_{DC} Max.
- Input Impedance: 3 kΩ, 0.33 W

Digital Output

- Output Channels: 4
- Output Type: Power Relay, Form A
- Contact Rating: 5 A @ (250 V_{AC}/30 V_{DC})
- ESD Protection: +/-4 kV Contact for Each Terminal
- EFT Protection: +/-4 kV for Power
- Surge Protection: +/-3 kV for Power
- Power Consumption: 1.2 W

Ordering Information

ZB-2042 CR	Wireless 14-channel Isolated Digital Output Module (RoHS)
ZB-2043 CR	Wireless 4-channel PhotoMOS Relay Output and 4-channel Open Collector Output Module (RoHS)
ZB-2052 CR	Wireless 14-channel Isolated Digital Input Module (RoHS)
ZB-2053 CR	Wireless 8-channel Isolated Digital Input Module with 16-bit Counters (RoHS)
ZB-2060 CR	Wireless 6-channel Isolated Digital Input and 4-channel Relay Output Module (RoHS)

Important Note: The ZigBee DIO modules need a ZB-2570 to coordinate the data transmission route, please remember to also order a ZB-2570 when you purchase the ZigBee DIO products.

ZigBee Repeater

NEW



ZB-2510

ZigBee Repeater

- RF Channels: 16
- Receive Sensitivity: -102 dBm
- Transmit Power: 12 dBm
- Data Encryption: AES-CTR
- Network Topology Support: Star, Mesh and Cluster tree
- Certification: TUV
- Antenna: 2.4 GHz, 3 dBi Omni-Directional antenna
- Power Consumption: 1.5 W

Ordering Information

ZB-2510 CR	ZigBee Repeater (RoHS)
------------	------------------------

PAC Family



Windows CE 5.0 Based PAC
WP-8000 Series
Linux 2.6.19 Based PAC
LP-8000 Series

MiniOS7 Based PAC
iP-8000



Embedded Ethernet/
Internet Micro-PAC
uPAC-7186



M2M Mini-PAC
G-4500 Series



Local Distributor

AGS-TECH Inc

Phone: +1-505-550-6501

Fax: +1-505-814-5778

Email: sales@agstech.net

Web: <http://www.agstech.net>